

SinglFuse™ SF-0402FPxxxF Series Features

- Single blow fuse for overcurrent protection
- 1005 (EIA 0402) miniature footprint
- Fast-acting precision fuse
- UL 248-14 listed
- RoHS compliant* and halogen free**
- Thin film chip design
- Surface mount packaging for automated assembly

SF-0402FPxxxF Series - Fast Acting Precision Surface Mount Fuses

Electrical Characteristics

Model	Rated Current (Amps)	Fusing Time	Resistance (Ω) Typ.***	Rated Voltage	Interrupting Rating	Typical I ² t (A ² s) ****
SF-0402FP020F	0.20	Open within 5 sec. at 300 % rated current	0.60	DC 35 V	DC 35 V 35 A	0.0017
SF-0402FP025F	0.25		0.33			0.0035
SF-0402FP0375F	0.375	Open within 5 sec. at 200 % rated current	0.24			0.0036
SF-0402FP050F	0.50		0.16			0.0060
SF-0402FP075F	0.75		0.10			0.0120
SF-0402FP100F	1.00		0.073			0.024
SF-0402FP125F	1.25		0.054			0.045
SF-0402FP150F	1.50		0.040			0.081
SF-0402FP175F	1.75		0.034			0.092
SF-0402FP200F	2.00		0.031			0.120

*** Resistance value measured with ≤10 % rated current at 25 °C ambient.

**** Melting I²t calculated at 0.001 second pre-arcing time.

Reliability Testing

No.	Test	Requirement	Test Condition	Test Reference
1	Bending	≤1 A: DCR change ≤ ±10 % >1 A: DCR change ≤ ±20 %	2 mm	Refer to STP document
2	Solderability	Minimum 95 % coverage	One dip at 255 °C for 5 seconds	MIL-STD-202 Method 208
3	Thermal shock	DCR change ≤ ±10 % No mechanical damage	100 cycles between -55 °C and +125 °C	MIL-STD-202 Method 107
4	Moisture resistance	DCR change ≤ ±10 % No excessive corrosion	10 cycles	MIL-STD-202 Method 106
5	Salt spray	DCR change ≤ ±10 % No excessive corrosion	48 hour exposure, 5 % salt solution	MIL-STD-202 Method 101
6	Mechanical vibration	DCR change ≤ ±10 % No mechanical damage	0.4 inch D.A. or 30 G between 5-3000 Hz	MIL-STD-202 Method 204
7	Mechanical shock	DCR change ≤ ±10 % No mechanical damage	1500 G, 0.5 ms, half-sine shocks	MIL-STD-202 Method 213
8	Life	No electrical "opens" during testing Voltage drop change shall be less than ±10 % of initial value	75 % rated current for 2000 hours at ambient temperature between +20 °C and +30 °C	Refer to STP document

Agency Recognition

UL File Number E198545

<http://www.ul.com/> Follow link to Online Certificates Directory, then enter UL File No. E198545, or [click here](#)

BOURNS®

Asia-Pacific: Tel: +886-2 2562-4117 • Email: asiacus@bourns.com

EMEA: Tel: +36 88 520 390 • Email: eurocus@bourns.com

The Americas: Tel: +1-951 781-5500 • Email: americus@bourns.com

www.bourns.com

* RoHS Directive 2015/863, Mar 31, 2015 and Annex.

** Bourns considers a product to be "halogen free" if (a) the Bromine (Br) content is 900 ppm or less; (b) the Chlorine (Cl) content is 900 ppm or less; and (c) the total Bromine (Br) and Chlorine (Cl) content is 1500 ppm or less.

"SinglFuse" is a trademark of Bourns, Inc.

Specifications are subject to change without notice.

The device characteristics and parameters in this data sheet can and do vary in different applications and actual device performance may vary over time.

Users should verify actual device performance in their specific applications.

SingIFuse™ SF-0402FPxxxF Series Applications

- Portable memory
- LCD monitors
- Disk drives
- PDAs
- Digital cameras
- MP3 players
- Cell phones
- Rechargeable battery packs
- Battery chargers
- Set-top boxes
- Industrial controllers
- Battery Management Systems (BMS)
- LED lighting
- Power tools

SF-0402FPxxxF Series - Fast Acting Precision Surface Mount Fuses BOURNS®

Environmental Characteristics

Operating Temperature.....-55 °C to +90 °C
 Storage Conditions
 Temperature +5 °C to +35 °C
 Humidity..... 40 % to 75 %
 Shelf Life.....2 years from manufacturing date
 Moisture Sensitivity Level..... 1
 ESD Classification (HBM)..... Class 6

Typical Part Marking

Represents total content. Layout may vary.



RATED CURRENT (A)

.. = 0.200	+ = 1.00
: = 0.250	x = 1.25
... = 0.375	= 1.50
= 0.500	≡ = 1.75
- = 0.750	≡≡ = 2.00

How to Order

SF - 0402 FP 050 F - 2

SingIFuse™
 Product Designator
 SMD Footprint
 0402 = 1005 (EIA 0402) size
 Fuse Blow Type
 FP = Fast acting precision
 Rated Current
 020 ~ 200 (200 mA ~ 2.00 A)
 Structure Type
 F = Thin film
 Packaging Type
 - 2 = Tape & Reel

Construction

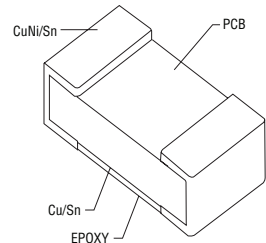

Packaging Quantity

20,000 pieces per 7-inch reel

Product Dimensions

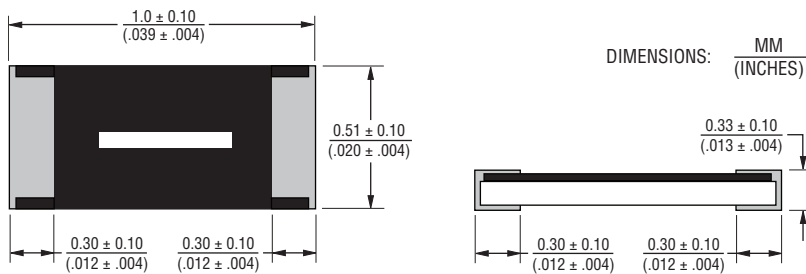

Recommended Pad Layout

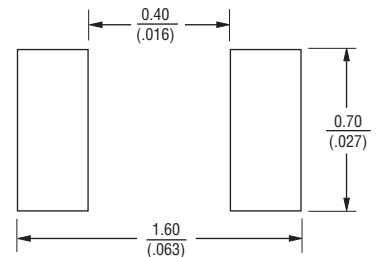

Current Rating Thermal Derating Curve

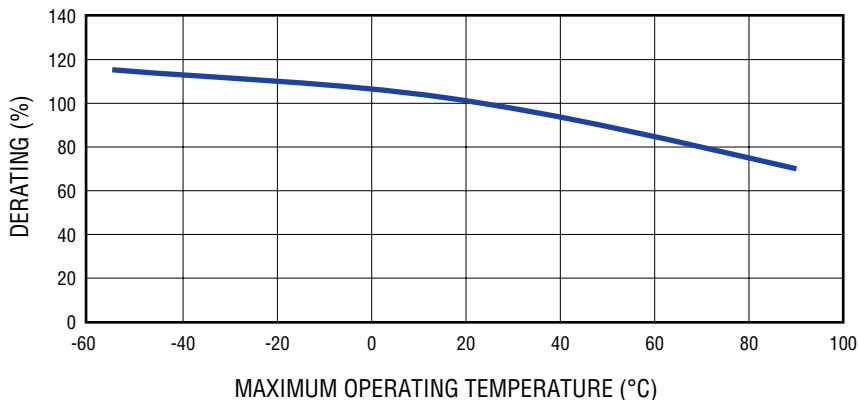

Specifications are subject to change without notice.
 The device characteristics and parameters in this data sheet can and do vary in different applications and actual device performance may vary over time.
 Users should verify actual device performance in their specific applications.

Solder Reflow Recommendations

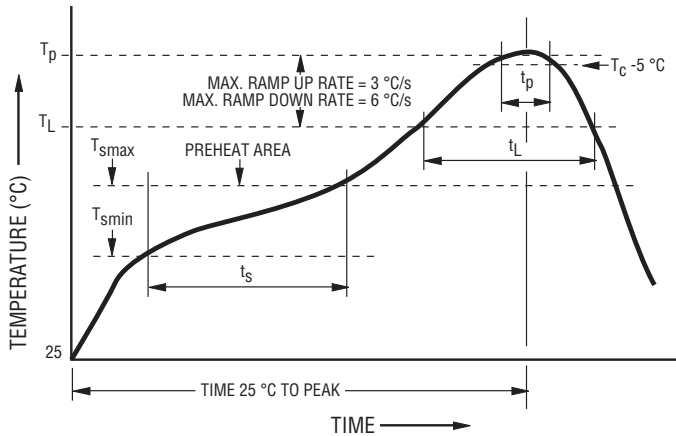

Profile Feature	Pb-Free Assembly
Preheat / Soak: Temperature Min. (T_{smin}) Temperature Max. (T_{smax}) Time (t_s) from (T_{smin} to T_{smax})	150 °C 200 °C 60~120 seconds
Ramp Up Rate (T_L to T_p)	3 °C / second max.
Liquidous Temperature (T_L) Time (t_L) maintained above T_L	217 °C 60~150 seconds
Peak Package Body Temperature (T_p)	260 °C
Time (t_p)* within 5 °C of the specified classification temperature (T_c)	30 seconds*
Ramp Down Rate (T_p to T_L)	6 °C / second max.
Time 25 °C to Peak Temperature	8 minutes max.

* Tolerance for peak profile temperature (T_p) is defined as a supplier minimum and a user maximum.

Average Pre-Arcing Time vs. Current Curves

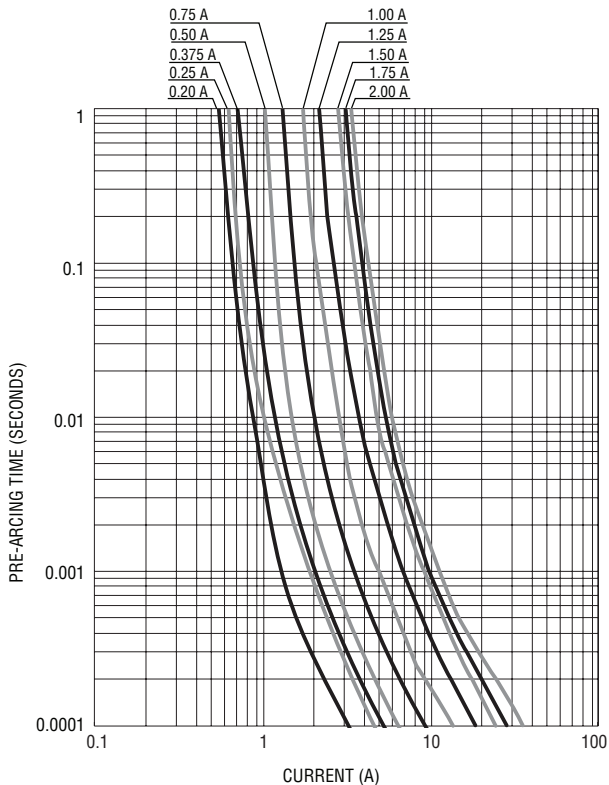

Average I^2t vs. t Curves

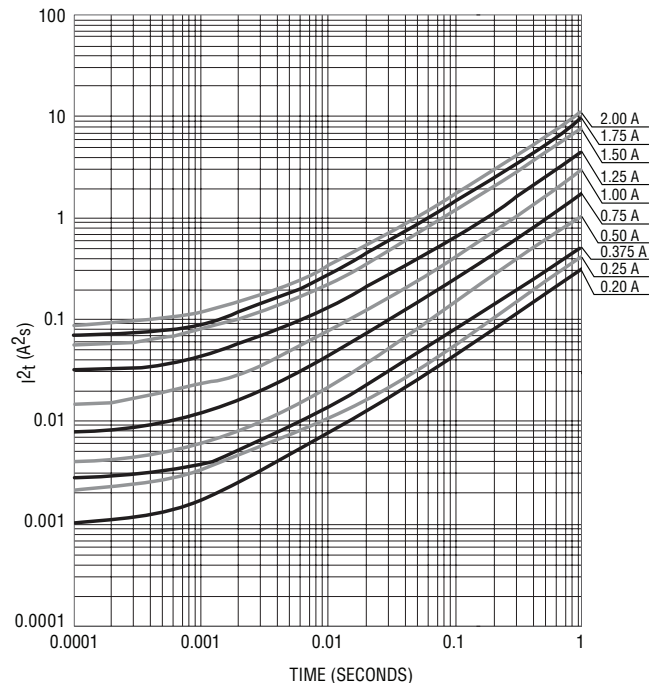

REV. C 05/18

Specifications are subject to change without notice.
The device characteristics and parameters in this data sheet can and do vary in different applications and actual device performance may vary over time.
Users should verify actual device performance in their specific applications.

SF-0402FPxxxF Series Tape and Reel Packaging Specifications

BOURNS®

SF-0402FPxxxF Series per EIA 481-2

Tape Dimensions

W	$\frac{8.00 \pm 0.10}{(.315 \pm .004)}$
P ₀	$\frac{4.0 \pm 0.10}{(.157 \pm .004)}$
P ₁	$\frac{2.0 \pm 0.05}{(.079 \pm .002)}$
P ₂	$\frac{2.0 \pm 0.05}{(.079 \pm .002)}$
A ₀	$\frac{0.61 \pm 0.05}{(.024 \pm .002)}$
B ₀	$\frac{1.15 \pm 0.05}{(.045 \pm .002)}$
F	$\frac{3.50 \pm 0.05}{(.138 \pm .002)}$
E ₁	$\frac{1.75 \pm 0.10}{(.069 \pm .004)}$
D ₀	$\frac{1.50 \pm 0.10}{(.059 \pm .004)}$
T	$\frac{0.43 \pm 0.03}{(.017 \pm .001)}$

PACKAGING: Paper tape, 20,000 pcs. per reel

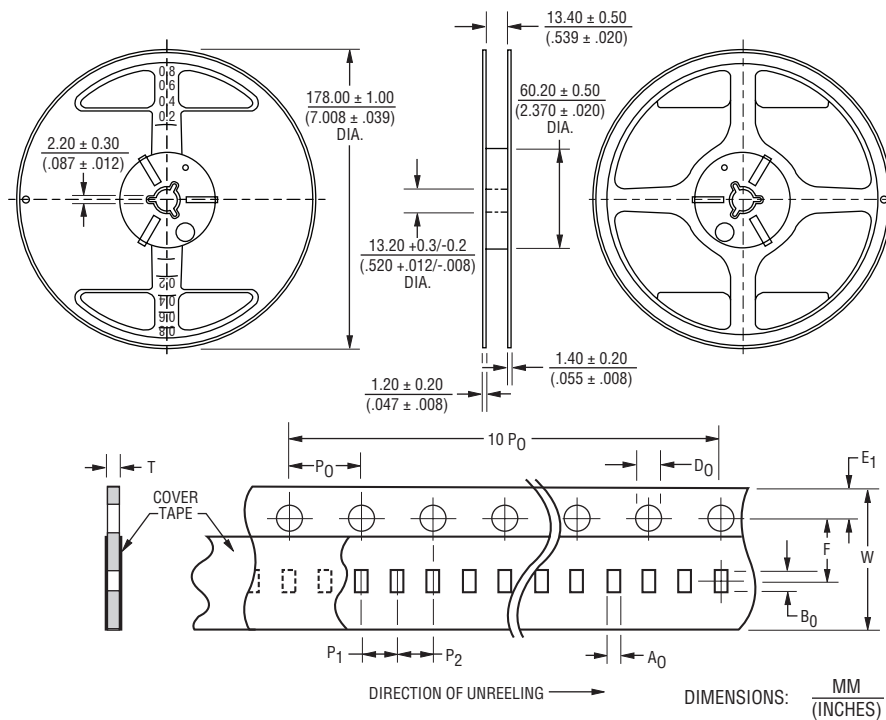

Specifications are subject to change without notice.

The device characteristics and parameters in this data sheet can and do vary in different applications and actual device performance may vary over time. Users should verify actual device performance in their specific applications.