

PET2000-12-074xA

AC-DC Front-End Power Supply

PET2000-12-074xA is a 2000 Watt AC to DC, power-factor corrected (PFC) power supply that converts standard AC power into a main output of +12 VDC.

PET2000-12-074xA utilizes full digital control architecture for greater efficiency, control and functionality.

This power supply meets international safety standards and displays the CE-Mark for the European Low Voltage Directive (LVD).



Key Features & Benefits

- Best-in-class, 80 PLUS Certified "Platinum" Efficiency
- Auto-Selected Input Voltage Ranges: 90 - 140 VAC, 180 - 264 VAC
- AC Input with Power Factor Correction
- 2000 W Continuous Output Power Capability
- Always-On 12 V Standby Output
- Hot-Plug Capable
- Parallel Operation with Active Current Sharing
- Full Digital Controls for Improved Performance
- High Density Design: 42.1 W/in³
- Small Form Factor: 73.5 x 40.0 x 265 mm
- PMBus® Communication Interface for Control, Programming and Monitoring
- Status LED with Fault Signaling

Applications

- Networking Switches
- Servers & Routers
- Telecommunications

Disclaimer: PMBus is a registered trademark of SMIF, Inc.

1. ORDERING INFORMATION

PET	2000	-	12	-	074	x	A	
Product Family	Power Level	Dash	V1 Output	Dash	Width	Airflow	Input	AC Inlet ¹
PET Front-Ends	2000 W		12 V		74 mm	N: Normal R: Reverse	A: AC	Blank: C14 C: C16 A: Saf-D-Grid®

2. OVERVIEW

The PET2000-12-074xA AC/DC power supply is a fully DSP controlled, highly efficient front-end power supply. It incorporates resonance-soft-switching technology to reduce component stresses, providing increased system reliability and very high efficiency. With a wide input operational voltage range the PET2000-12-074xA maximizes power availability in demanding server, network, and other high availability applications. The supply is fan cooled and ideally suited for integration with a matching airflow path. The PFC stage is digitally controlled using a state-of-the-art digital signal processing algorithm to guarantee best efficiency and unity power factor over a wide operating range. The DC/DC stage uses soft switching resonant techniques in conjunction with synchronous rectification. An active OR-ing device on the output ensures no reverse load current and renders the supply ideally suited for operation in redundant power systems. The always-on standby output provides power to external power distribution and management controllers. It is protected with an active OR-ing device for maximum reliability. Status information is provided with a front-panel LED. In addition, the power supply can be controlled and the fan speed set via the I2C bus. The I2C bus allows full monitoring of the supply, including input and output voltage, current, power, and inside temperatures. Cooling is managed by a fan controlled by the DSP controller. The fan speed is adjusted automatically depending on the actual power demand and supply temperature and can be overridden through the I²C bus.

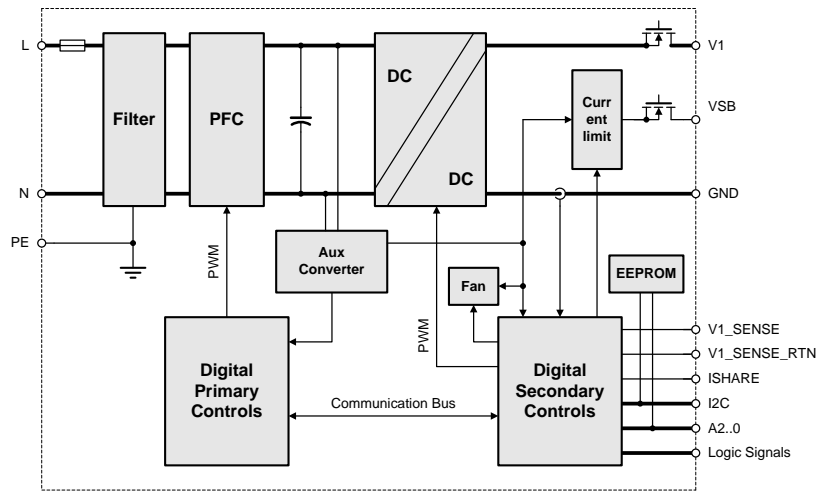

Figure 1. PET2000-12-074xA Block Diagram

3. ABSOLUTE MAXIMUM RATINGS

Stresses in excess of the absolute maximum ratings may cause performance degradation, adversely affect long-term reliability and cause permanent damage to the supply.

PARAMETER	CONDITIONS / DESCRIPTION	MIN	MAX	UNITS
<i>V_{i maxc}</i>	Maximum Input		264	VAC

¹ C14 = IEC 60320-C14 type, C16 = IEC 60320-C16 type, Saf-D-Grid® = Anderson Saf-D-Grid®

4. INPUT

General Condition: $T_A = 0 \dots 55 \text{ }^\circ\text{C}$, unless otherwise noted.

PARAMETER	DESCRIPTION / CONDITION	MIN	NOM	MAX	UNIT	
$V_{i\text{nom}}$	Nominal Input Voltage	Rated Voltage High Line ($V_{i\text{nom HL}}$)	200	230	240	VAC
		Rated Voltage Low Line ($V_{i\text{nom LL}}$)	100	115	127	VAC
V_i	Input Voltage Ranges	Normal operating ($V_{i\text{min HL}}$ to $V_{i\text{max HL}}$), High Line	180		264	VAC
		Normal operating ($V_{i\text{min LL}}$ to $V_{i\text{max LL}}$), Low Line	90		140	VAC
$I_{i\text{max}}$	Maximum Input Current	$V_i=100 \text{ VAC}$, $I_l=83 \text{ A}$, $I_{SB}=5 \text{ A}$			13	
		$V_i=200 \text{ VAC}$, $I_l=167 \text{ A}$, $I_{SB}=5 \text{ A}$			12	
		$V_i=200 \text{ VAC}$, $I_l=145 \text{ A}$, $I_{SB}=5 \text{ A}$			10	ARMS
		$V_i=220 \text{ VAC}$, $I_l=158 \text{ A}$, $I_{SB}=5 \text{ A}$			10	
		$V_i=230 \text{ VAC}$, $I_l=167 \text{ A}$, $I_{SB}=5 \text{ A}$			10	
$I_{i\text{inrush}}$	Inrush Current Limitation	$V_{i\text{min}}$ to $V_{i\text{max}}$, $T_{NTC}=25^\circ\text{C}$, 5 ms			10	A_p
f_i	Input Frequency	47	50/60	63	Hz	
PF	Power Factor	$V_i=230 \text{ VAC}$, 10% load	0.8	0.880		W/VA
		$V_i=230 \text{ VAC}$, 20% load	0.9	0.950		W/VA
		$V_i=230 \text{ VAC}$, 50% load	0.9	0.997		W/VA
		$V_i=230 \text{ VAC}$, 100% load	0.95	0.999		W/VA
THD	Total Harmonic Distortion	TBD			TBD	%
$V_{i\text{on}}$	Turn-on Input Voltage ²	Ramping up		87	90	VAC
$V_{i\text{off}}$	Turn-off Input Voltage ²	Ramping down		82	87	VAC
η	Efficiency ³	$V_i=230 \text{ VAC}$, 10% load	90	91.6		%
		$V_i=230 \text{ VAC}$, 20% load	91	93.8		%
		$V_i=230 \text{ VAC}$, 50% load	94	94.4		%
		$V_i=230 \text{ VAC}$, 100% load	91	92.8		%
$T_{V1\text{ holdup}}$	Hold-up Time V_i	$V_i=230 \text{ VAC}$, 50% load, 0°	18			ms
		$V_i=230 \text{ VAC}$, 100% load, 0°	9			ms
$T_{VSB\text{ holdup}}$	Hold-up Time V_{SB}	$V_i=90$ to 264 VAC , 0 to 100% load		70		ms

4.1 INPUT CONNECTOR

PET2000-12-074NA power supply is available in 3 different input connector configurations. The versions with IEC 60320-C14 and IEC 60320-C16 have a limited current of 10 A for areas outside North America, in addition the IEC 60320-C14 has a limited component temperature of 70°C. The Anderson Saf-D-Grid® has no limitation with respect to both current and temperature.

The PET2000-12-074NA power supply is available with IEC 60320-C14.

Below table shows the maximum rated operating conditions for the different input connector options. The applied operating condition must remain within these conditions to allow safety compliant operation.

See also [10.3 MAXIMUM OUTPUT POWER VERSUS INLET TEMPERATURE FOR SAFETY COMPLIANCY](#) for detailed derating curves.

² The Front-End is provided with a minimum hysteresis of 3 V during turn-on and turn-off within the ranges

³ Efficiency measured without fan power per EPA server guidelines

TYPE	INPUT CONNECTOR	REGION	APPLIED RATED MAINS AC VOLTAGE ⁴	MAX I ⁵	MAXIMUM DERATED I _r AT MAXIMUM T _A
PET2000-12-074RA	IEC 60320-C14	North America	100 to 127 VAC	83 A	50 A at T _A = 55°C
			200 to 240 VAC	167 A	100 A at T _A = 55°C
		Other than North America	100 to 127 VAC	83 A	50 A at T _A = 55°C
			200 to 220 VAC	145 A	100 A at T _A = 55°C
			220 to 230 VAC	158 A	100 A at T _A = 55°C
PET2000-12-074NA	IEC 60320-C14	North America	100 to 127 VAC	83 A	50 A at T _A = 70°C
			200 to 240 VAC	167 A	80 A at T _A = 70°C
		Other than North America	100 to 127 VAC	67 A	17.5 A at T _A = 65°C
			200 to 220 VAC	145 A	32.5 A at T _A = 65°C
			220 to 230 VAC	158 A	40 A at T _A = 65°C
PET2000-12-074NAC	IEC 60320-C16	North America	100 to 127 VAC	83 A	50 A at T _A = 70°C
			200 to 240 VAC	167 A	80 A at T _A = 70°C
		Other than North America	100 to 127 VAC	67 A	40 A at T _A = 70°C
			200 to 220 VAC	145 A	87 A at T _A = 70°C
			220 to 230 VAC	158 A	95 A at T _A = 70°C
PET2000-12-074NAA	Anderson Saf-D-Grid®	All	230 to 240 VAC	167 A	100 A at T _A = 70°C
			100 to 127 VAC	83 A	50 A at T _A = 70°C
			200 to 240 VAC	167 A	100 A at T _A = 70°C

4.2 INPUT FUSE

Time-lag 16 A input fuse (5 x 20 mm) in series with the L-line inside the power supply protects against severe defects. The fuse is not accessible from the outside and is therefore not a serviceable part.

4.3 INRUSH CURRENT

The AC-DC power supply exhibits an X-capacitance of only 5.9 µF, resulting in a low and short peak current, when the supply is connected to the mains. The internal bulk capacitor will be charged through an NTC which will limit the inrush current.

NOTE:

Do not repeat plug-in / out operations within a short time, or else the internal in-rush current limiting device (NTC) may not sufficiently cool down and excessive inrush current or component failure(s) may result.

4.4 INPUT UNDER-VOLTAGE

If the sinusoidal input voltage stays below the input undervoltage lockout threshold V_{i on}, the supply will be inhibited. Once the input voltage returns within the normal operating range, the supply will return to normal operation again.

⁴ Nominal grid voltage, does not include typical fluctuations of ±10%; e.g. listed range 230-240 VAC allows operation at 230 VAC -10% to 240 VAC +10%, so 207 ... 264 VAC actual voltage to account for grid fluctuations

⁵ Maximum Input current for PET2000-12-074RA at T_A = 40°C and for PET2000-12-074NAx at T_A = 55°C

4.5 POWER FACTOR CORRECTION

Power factor correction (PFC) is achieved by controlling the input current waveform synchronously with the input voltage. A fully digital controller is implemented giving outstanding PFC results over a wide input voltage and load ranges. The input current will follow the shape of the input voltage. If for instance the input voltage has a trapezoidal waveform, then the current will also show a trapezoidal waveform.

4.6 EFFICIENCY

High efficiency (see *Figure 2*) is achieved by using state-of-the-art silicon power devices in conjunction with soft-transition topologies minimizing switching losses and a full digital control scheme. Synchronous rectifiers on the output reduce the losses in the high current output path. The speed of the fan is digitally controlled to keep all components at an optimal operating temperature regardless of the ambient temperature and load conditions.

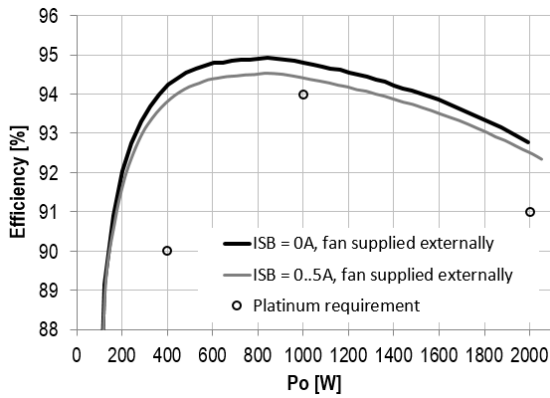

Figure 2. Efficiency vs. Load current (ratio metric loading)

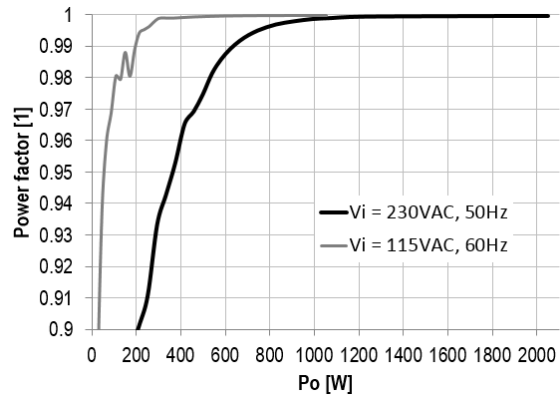

Figure 3. Power factor vs. Load current

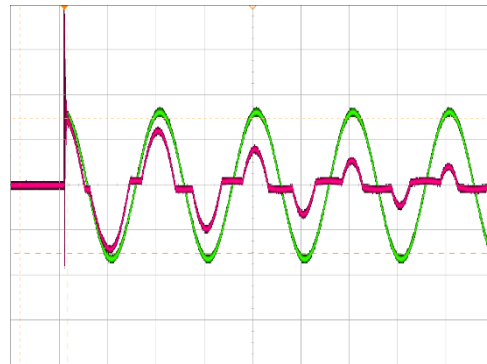

Figure 4. Inrush current, $V_i = 230Vac, 90^\circ$
 CH2: V_i (200V/div), CH3: I_i (5A/div)

5. OUTPUT

5.1 MAIN OUTPUT V_1

General Condition: $T_A = 0 \dots 40 \text{ }^\circ\text{C}$ (PET2000-12-074RA), $T_A = 0 \dots 55 \text{ }^\circ\text{C}$ (PET2000-12-074NA), $V_i = 230 \text{ VAC}$ unless otherwise noted.

PARAMETER	DESCRIPTION / CONDITION	MIN	NOM	MAX	UNIT	
$V_{1 \text{ nom}}$	Nominal Output Voltage		12.0		VDC	
$V_{1 \text{ set}}$	Output Setpoint Accuracy	-0.5		+0.5	% $V_{1 \text{ nom}}$	
$dV_{1 \text{ tot}}$	Static Regulation	$V_{i \text{ min LL}}$ to $V_{i \text{ max HL}}$, 0 to 100% $I_{1 \text{ nom}}$			% $V_{1 \text{ nom}}$	
$P_{1 \text{ nom}}$	Nominal Output Power ⁶	$V_{i \text{ min HL}}$ to $V_{i \text{ max HL}}$	2000		W	
		$V_{i \text{ min LL}}$ to $V_{i \text{ max LL}}$	1000		W	
$P_{1 \text{ peak}}$	Peak Output Power ⁶	$V_{i \text{ min HL}}$ to $V_{i \text{ max HL}}$	2100		W	
		$V_{i \text{ min LL}}$ to $V_{i \text{ max LL}}$	1320		W	
$I_{1 \text{ nom}}$	Output Current	$V_{i \text{ min HL}}$ to $V_{i \text{ max HL}}$	0	167	ADC	
$I_{1 \text{ nom red}}$		$V_{i \text{ min LL}}$ to $V_{i \text{ max LL}}$	0	83	ADC	
$I_{1 \text{ peak}}$	Peak Output Current ⁷	$V_{i \text{ min HL}}$ to $V_{i \text{ max HL}}$	0	175	ADC	
$I_{1 \text{ peak red}}$		$V_{i \text{ min LL}}$ to $V_{i \text{ max LL}}$	0	110	ADC	
$V_{1 \text{ pp}}$	Output Ripple Voltage ⁸	$V_{i \text{ min LL}}$ to $V_{i \text{ max HL}}$, 0 to 75% $I_{1 \text{ nom}}$, $C_{\text{ext}} = 0 \text{ mF}$		120	mVpp	
		$V_{i \text{ min LL}}$ to $V_{i \text{ max HL}}$, 75 to 100% $I_{1 \text{ nom}}$, $C_{\text{ext}} = 0 \text{ mF}$		150	mVpp	
		$V_{i \text{ min LL}}$ to $V_{i \text{ max HL}}$, 0 to 100% $I_{1 \text{ nom}}$, $C_{\text{ext}} \geq 1 \text{ mF/Low ESR}$		120	mVpp	
$dV_{1 \text{ load}}$	Load Regulation	0 to 100% $I_{1 \text{ nom}}$	-83	-110	-138	mV
$dV_{1 \text{ line}}$	Line Regulation	$V_{i \text{ min HL}}$ to $V_{i \text{ max HL}}$, $0.5 \cdot I_{1 \text{ nom}}$	-24	0	24	mV
$dV_{1 \text{ temp}}$	Thermal Drift	$0.5 \cdot I_{1 \text{ nom}}$, $T_A = 0 \dots 55^\circ\text{C}$		-0.4		mV/ $^\circ\text{C}$
$dI_{1 \text{ share}}$	Current Sharing	Difference between individual I_{1i} , 1 ... 8 power supplies in parallel	-6		+6	ADC
$V_{i \text{ SHARE}}$	Current Share Bus Voltage	$V_{i \text{ SHARE}}$ at 167A		8		VDC
$V_{i \text{ SHARE}}$	Current Share Bus Voltage	$I_{1 \text{ peak}}$		9.14		VDC
$dV_{1 \text{ lt}}$	Load Transient Response	$\Delta I_1 = 50\% I_{1 \text{ nom}}$, $I_1 = 5 \dots 100\% I_{1 \text{ nom}}$, $C_{\text{ext}} = 0 \text{ mF}$		0.35	0.6	VDC
$dV_{1 \text{ lt}}$		$\Delta I_1 = 10\% I_{1 \text{ nom}}$, $I_1 = 0 \dots 10\% I_{1 \text{ nom}}$, $C_{\text{ext}} = 0 \text{ mF}$		0.35	0.6	VDC
t_{rec}	Recovery Time	$dI_1/dt = 1\text{A}/\mu\text{s}$, recovery within 1% of $V_{1 \text{ nom}}$		0.5	1	ms
$V_{1 \text{ dyn}}$	Dynamic Load Regulation	$\Delta I_1 = 60\% I_{1 \text{ nom}}$, $I_1 = 5 \dots 167 \text{ A}$, $f = 50 \dots 5000 \text{ Hz}$, Duty cycle = 10 ... 90%, $C_{\text{ext}} = 2 \dots 30 \text{ mF}$	11.4		12.6	V
$t_{V1 \text{ rise}}$	Output Voltage Rise Time	$V_1 = 10 \dots 90\% V_{1 \text{ nom}}$, $C_{\text{ext}} < 10 \text{ mF}$	1		30	ms
$t_{V1 \text{ ovr sh}}$	Output Turn-on Overshoot	0 to 100% $I_{1 \text{ nom}}$			0.6	V
$dV_{1 \text{ sense}}$	Remote Sense	Compensation for cable drop, 0 to 100% $I_{1 \text{ nom}}$			0.25	V
$C_{V1 \text{ load}}$	Capacitive Loading		0		30	mF

⁶ See also chapter [TEMPERATURE AND FAN CONTROL](#)

⁷ Peak combined power for all outputs must not exceed 2100 W; maximum of peak power duration is 20 seconds without asserting the SMBAlert signal

⁸ Measured with a 10 μF low ESR capacitor in parallel with a 0.1 μF ceramic capacitor at the point of measurement

5.2 STANBY OUTPUT V_{SB}

General Condition: $T_A = 0...40\text{ }^\circ\text{C}$ (PET2000-12-074RA), $T_A = 0...55\text{ }^\circ\text{C}$ (PET2000-12-074NA), $V_i = 230\text{ VAC}$ unless otherwise noted.

PARAMETER	DESCRIPTION / CONDITION	MIN	NOM	MAX	UNIT
$V_{SB\ nom}$	Nominal Output Voltage		12.1		VDC
$V_{SB\ set}$	Output Setpoint Accuracy	-1		+1	% $V_{SB\ nom}$
$dV_{SB\ tot}$	Total Regulation	-5		+1	% $V_{SB\ nom}$
$P_{SB\ nom}$	Nominal Output Power		36		W
$P_{SB\ peak}$	Peak Output Power ⁹		60		W
$I_{SB\ nom}$	Output Current	0		3	ADC
$I_{SB\ peak}$	Peak Output Current ⁹	0		5.3	ADC
$V_{SB\ pp}$	Output Ripple Voltage ⁷			120	mVpp
$dV_{SB\ load}$	Load Regulation	-144	-240	-330	mV
$dV_{SB\ line}$	Line Regulation	-290	-430	-570	mV
$dV_{SB\ temp}$	Thermal Drift		-0.5		mV/ $^\circ\text{C}$
$dI_{SB\ share}$	Current Sharing	-1		+1	ADC
$V_{SB\ dyn}$	Load Transient Response		0.2	0.3	VDC
t_{rec}	Recovery Time		1	2	ms
$V_{SB\ dyn}$	Dynamic Load Regulation	11.4		12.6	V
$t_{V_{SB}\ rise}$	Output Voltage Rise Time	1	2	5	ms
$t_{V_{SB}\ ovr\ sh}$	Output Turn-on Overshoot			0.6	V
$C_{V_{SB}\ load}$	Capacitive Loading	0		3100	μF

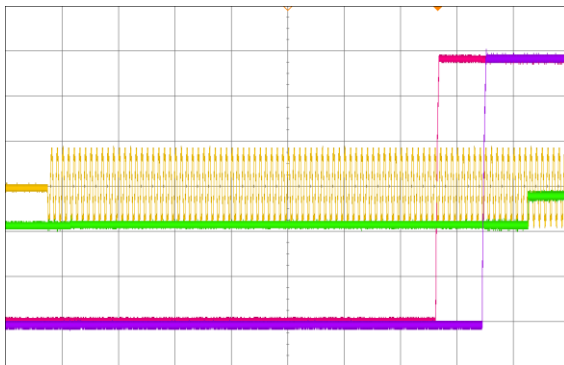

Figure 5. Turn-On AC Line 230VAC, full load (200ms/div)
 CH1: V_{in} (400V/div) CH2: PWOK_H (5V/div)
 CH3: V_1 (2V/div) CH4: V_{SB} (2V/div)

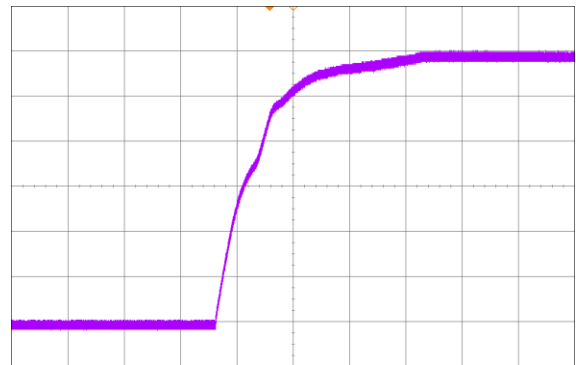

Figure 6. Rise time V_1 at 230VAC, full load (2ms/div)
 CH3: V_1 (2V/div)

⁹ In single power supply configuration

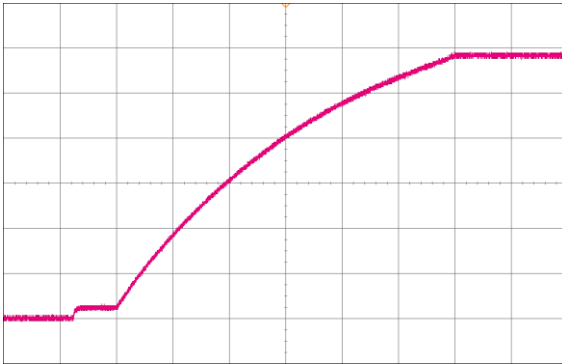

Figure 7. Rise time V_{SB} at 230VAC, full load (2ms/div)
CH4: V_{SB} (2V/div)

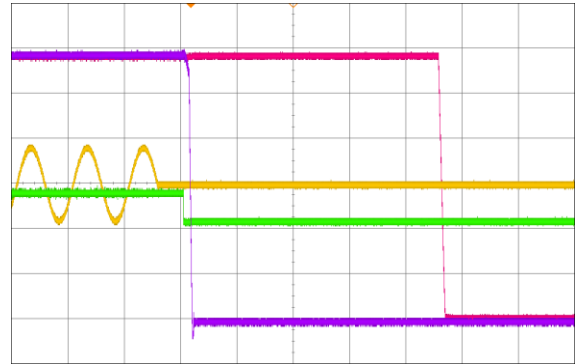

Figure 8. Turn-Off AC Line 230VAC, full load (20ms/div)
CH1: V_{in} (400V/div) CH2: PWOK_H (5V/div)
CH3: V_1 (2V/div) CH4: V_{SB} (2V/div)

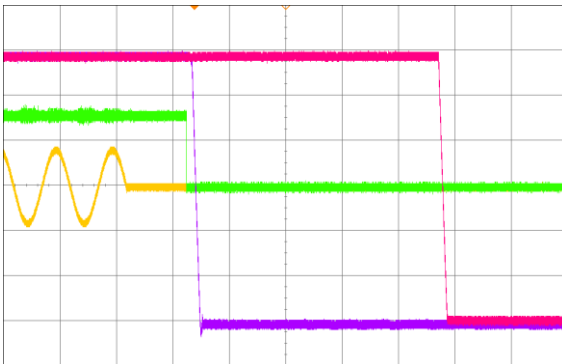

Figure 9. Turn-Off AC Line 230VAC, half load (20ms/div)
CH1: V_{in} (400V/div) CH2: PWOK_H (5V/div)
CH3: V_1 (2V/div) CH4: V_{SB} (2V/div)

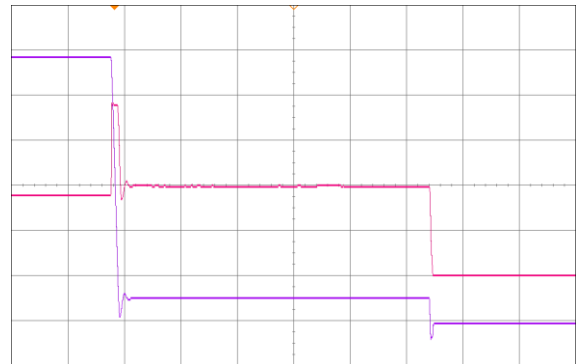

Figure 10. Short circuit on V_1 (10ms/div)
CH3: V_1 (2V/div) CH4: I_1 (100A/div)

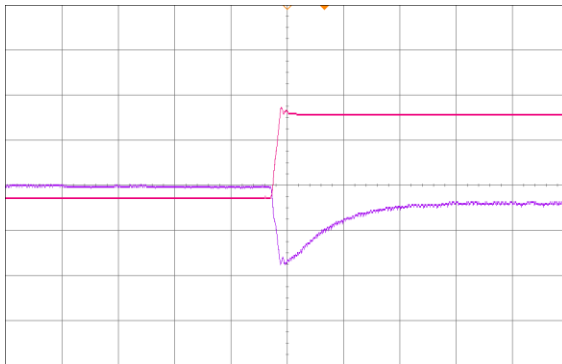

Figure 11. Load transient V_1 , 83 to 167A (500 μ s/div)
CH3: V_1 (200mV/div) CH4: I_1 (50A/div)

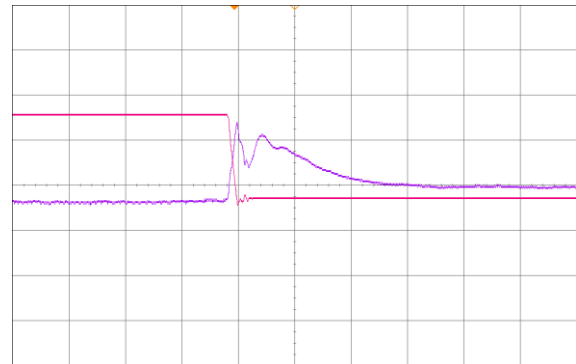

Figure 12. Load transient V_1 , 167 to 83A (500 μ s/div)
CH3: V_1 (200mV/div) CH4: I_1 (50A/div)

5.3 OUTPUT GROUND / CHASSIS CONNECTION

The output return path serves as power and signal ground. All output voltages and signals are referenced to these pins. To prevent a shift in signal and voltage levels due to ground wiring voltage drop a low impedance ground plane should be used as shown in [Figure 13](#). Alternatively, separated ground signals can be used as shown in

[Figure 14](#). In this case the two ground planes should be connected together at the power supplies ground pins.

NOTE:

Within the power supply the output GND pins are connected to the Chassis, which in turn is connected to the Protective Earth terminal on the AC inlet. Therefore, it is not possible to set the potential of the output return (GND) to any other than Protective Earth potential.

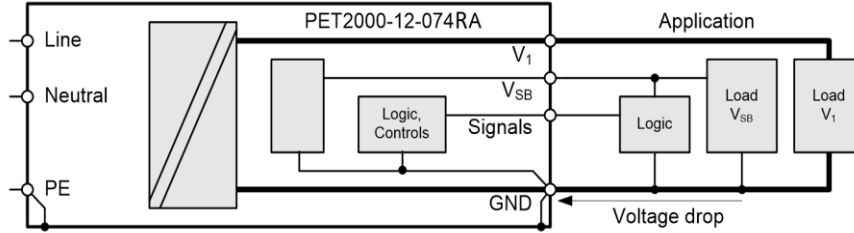

Figure 13. Common low impedance ground plane

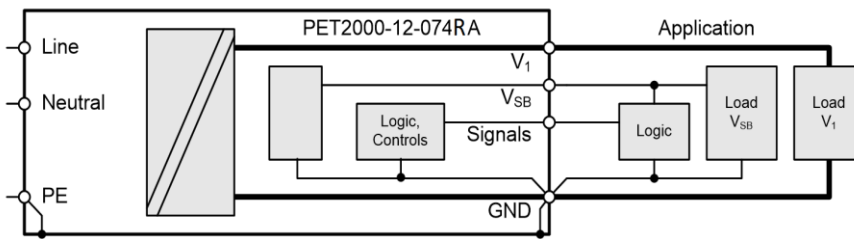

Figure 14. Separated power and signal ground

6. PROTECTION

PARAMETER	DESCRIPTION / CONDITION	MIN	NOM	MAX	UNIT
F	Input fuse (L)		16		A
$V_{1\text{ OV}}$	OV Threshold V_1	13.3	13.9	14.5	VDC
$t_{V1\text{ OV}}$	OV Trip Time V_1			1	ms
$V_{SB\text{ OV}}$	OV Threshold V_{SB}	13.3	13.9	14.5	VDC
$t_{VSB\text{ OV}}$	OV Trip Time V_{SB}			1	ms
$I_{1\text{ OC Slow}}$	OC Limit V_1	169		175	ADC
	Over Current Limitation, Latch-off, $V_{1\text{ min HL}}$ to $V_{1\text{ max HL}}$				
	Over Current Limitation, Latch-off, $V_{1\text{ min LL}}$ to $V_{1\text{ max LL}}$	85		88	ADC
$t_{V1\text{ OC Slow}}$	OC Trip time V_1	20			s
	Over Current Limitation, Latch-off time				
$I_{V1\text{ OC Fast}}$	Fast OC Limit V_1	176		180	ADC
	Fast Over Current Limit., Latch-off, $V_{1\text{ min HL}}$ to $V_{1\text{ max HL}}$				
	Fast Over Current Limit., Latch-off, $V_{1\text{ min LL}}$ to $V_{1\text{ max LL}}$	110		115	ADC
$t_{V1\text{ OC Fast}}$	Fast OC Trip time V_1	50	55	60	ms
	Fast Over Current Limitation, Latch-off time				
$I_{1\text{ SC}}$	Max Short Circuit Current I_1			180	A
	$V_1 < 3\text{ V}$				
$t_{V1\text{ SC}}$	Short Circuit Regulation Time			2	ms
	$V_1 < 3\text{ V}$, time until I_1 is limited to $< I_{1\text{ SC}}$				
$I_{SB\text{ OC}}$	OC Limit V_{SB}	5.2		7.5	A
	Over Current Limitation, Constant-Current Type				
$t_{VSB\text{ OC}}$	OC Trip time V_{SB}			1	ms
	Over Current Limit., time until I_{SB} is limited to $I_{SB\text{ OC}}$				
T_{SD}	Over Temperature				°C
	See chapter 10.2				

6.1 OVERVOLTAGE PROTECTION

PET2000-12-074xA front-end provides a fixed threshold overvoltage (OV) protection implemented with a HW comparator for both the main and the standby output. Once an OV condition has been triggered on the main output, the supply will shut down and latch the fault condition. The latch can be unlocked by disconnecting the supply from the AC mains or by toggling the PSON_L input. The standby output will continuously try to restart with a 1 s interval after OV condition has occurred.

6.2 UNDERVOLTAGE DETECTION

Both main and standby outputs are monitored. LED and PWOK_H pin signal if the output voltage exceeds $\pm 5\%$ of its nominal voltage.

The main output will latch off if the main output voltage V_I falls below 10 V (typically in an overload condition) for more than 55 ms. The latch can be unlocked by disconnecting the supply from the AC mains or by toggling the PSON_L input. If the standby output leaves its regulation bandwidth for more than 2 ms then the main output is disabled to protect the system.

6.3 CURRENT LIMITATION

MAIN OUTPUT

The main output exhibits a substantially rectangular output characteristic controlled by a software feedback loop. If output current exceeds $I_{V1\ OC\ Fast}$ it will reduce output voltage in order to keep output current at $I_{V1\ OC\ Fast}$. If the output voltage drops below ~ 10.0 VDC for more than 55 ms, the output will latch off (standby remains on), see also [Undervoltage Detection](#).

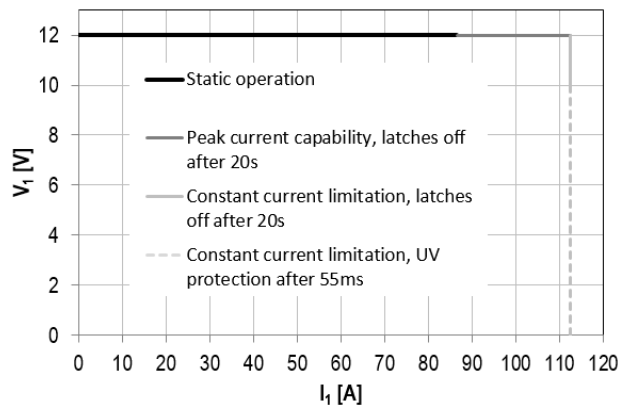

Figure 15. Current Limitation on V_I
at $V_I = 90 \dots 140$ VAC

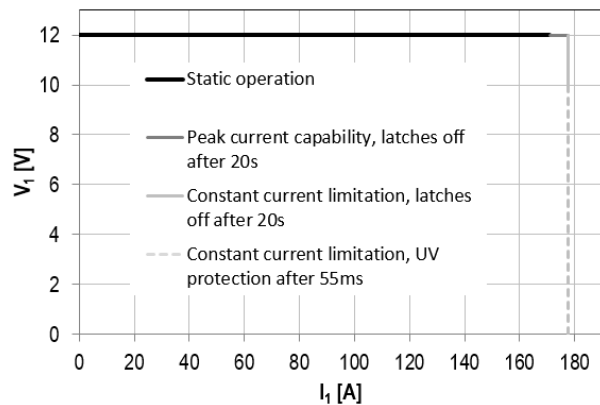

Figure 16. Current Limitation on V_I
at $V_I = 180 \dots 264$ VAC

A second SW controlled current limit will latch off the main output if the power supply is operated for long duration in its peak current capability region. This protection trips as soon as the output current exceeds $I_{I\ OC\ Slow}$ for a duration of more than 20 s. The third current limitation implemented as a fast hardware circuit will immediately switch off the main output if the output current increases beyond the peak current trip point, occurring mainly if a short circuit is applied to the output voltage. The supply will re-start 4 ms later with a soft start, if the short circuit persists ($V_I < 10.0$ V for >55 ms) the output will latch off; otherwise it continues to operate.

The latch can be unlocked by disconnecting the supply from the AC mains or by toggling the PSON_L input.

The main output current limitation thresholds for $I_{I\ OC\ Slow}$ and $I_{I\ OC\ Fast}$ depend on the actual input voltage range applied to the power supply. In addition, the threshold for $I_{I\ OC\ Slow}$ is reduced when ambient temperature exceeds 55°C , see [Figure 38](#) for PET2000-12-074RA and [Figure 46](#) for PET2000-12-074NA.

STANDBY OUTPUT

The standby output exhibits a substantially rectangular output characteristic down to 0 V (no hiccup mode / latch off).

The current limitation of the standby output is independent of the AC input voltage.

Running in current limitation causes the output voltage to fall, this will trigger under voltage protection and disables the main output, see also [Undervoltage Detection](#).

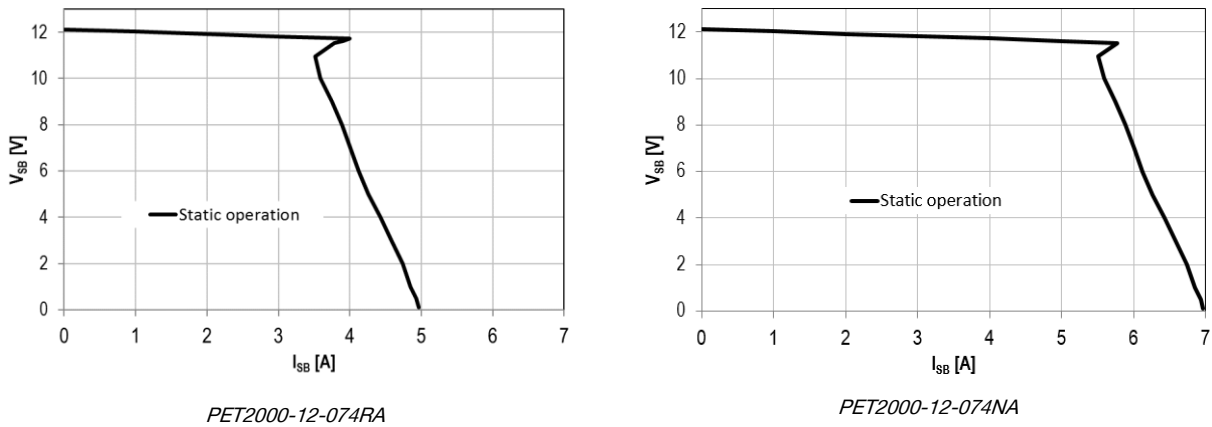

Figure 17. Current Limitation on Vsb

7. MONITORING

The power supply operating parameters can be accessed through I²C interface. For more details refer to chapter I²C / PMBus® COMMUNICATION and document URP.00234 (PET Front-End PMBus® Communication Manual).

PARAMETER	DESCRIPTION / CONDITION	MIN	NOM	MAX	UNIT
$V_{i\ mon}$	Input RMS Voltage $V_{i\ min\ LL} \leq V_i \leq V_{i\ max\ HL}$	-3		+3	VAC
$I_{i\ mon}$	Input RMS Current $I_i > 6.7\ Arms$ $I_i \leq 6.7\ Arms$	-3		+3	%
$P_{i\ mon}$	True Input Power $P_i > 500\ W$ $50\ W < P_i \leq 500\ W$	-4		+4	%
$V_{1\ mon}$	V1 Voltage	-0.1		+0.1	VDC
$I_{1\ mon}$	V1 Current $I_1 > 50\ A$ $5\ A < I_1 \leq 50\ A$	-1		+1	%
$P_{1\ mon}$	V1 Output Power $P_o > 1000\ W$ $50\ W < P_o \leq 1000\ W$	-10		+10	W
$V_{SB\ mon}$	VSB Voltage	-0.1		+0.1	VDC
$I_{SB\ mon}$	VSB Current	-0.1		+0.1	ADC
$T_{A\ mon}$	Inlet Temperature $T_{A\ min} \leq T_A \leq T_{A\ max}$	-2		+2	°C

8. SIGNALING AND CONTROL

8.1 ELECTRICAL CHARACTERISTICS

PARAMETER	DESCRIPTION / CONDITION	MIN	NOM	MAX	UNIT	
PSON_H / HOTSTANDBYEN_H						
V_{IL}	Input Low Level Voltage	PSON_L: Main output enabled HOTSTANDBYEN_H: Hot Standby mode not allowed		-0.2	0.8	V
V_{IH}	Input High Level Voltage	PSON_L: Main output disabled HOTSTANDBYEN_H: Hot Standby mode allowed		2	3.5	V
$I_{IL,H}$	Maximum Input Sink or Source Current	$V_I = -0.2\text{ V to }+3.5\text{ V}$		-1	1	mA
$R_{pull\ up}$	Internal Pull up Resistor to internal 3.3 V				10	k Ω
R_{LOW}	Maximum external Pull down Resistance to GND to obtain Low Level				1	k Ω
R_{HIGH}	Minimum external Pull down Resistance to GND to obtain High Level			50		k Ω
PWOK_H						
V_{OL}	Output Low Level Voltage	V_I or V_{SB} out of regulation, $I_{sink} < 4\text{ mA}$		0	0.4	V
V_{OH}	Output High Level Voltage	V_I and V_{SB} in regulation, $I_{source} < 0.5\text{ mA}$		2.4	3.5	V
$R_{pull\ up}$	Internal Pull up Resistor to internal 3.3 V				1	k Ω
I_{OL}	Maximum Sink Current	$V_O < 0.4\text{ V}$			4	mA

8.2 SENSE INPUTS

The main output has sense lines implemented to compensate for voltage drop on load wires in both positive and negative path. The maximum allowed voltage drop is 200 mV on the positive rail and 50 mV on the GND rail.

With open sense inputs the main output voltage will rise by 270 mV. Therefore, if not used, these inputs should be connected to the power output and GND at the power supply connector. The sense inputs are protected against short circuit. In this case the power supply will shut down.

8.3 CURRENT SHARE

The PET front-ends have an active current share scheme implemented for V_I . All the ISHARE current share pins need to be interconnected in order to activate the sharing function. If a supply has an internal fault or is not turned on, it will disconnect its ISHARE pin from the share bus. This will prevent dragging the output down (or up) in such cases.

The current share function uses an analog bus to transmit and receive current share information. The controller implements a Master/Slave current share function. The power supply providing the largest current among the group is automatically the Master. The other supplies will operate as Slaves and increase their output current to a value close to the Master by slightly increasing their output voltage. The voltage increase is limited to +250 mV.

The standby output uses a passive current share method (droop output voltage characteristic).

8.4 PSON_L INPUT

The PSON_L is an internally pulled-up (3.3 V) input signal to enable/disable the main output V_I of the front-end. With low level input the main output is enabled. This active-low pin is also used to clear any latched fault condition. The PSON_L can be either controlled by an open collector device or by a voltage source.

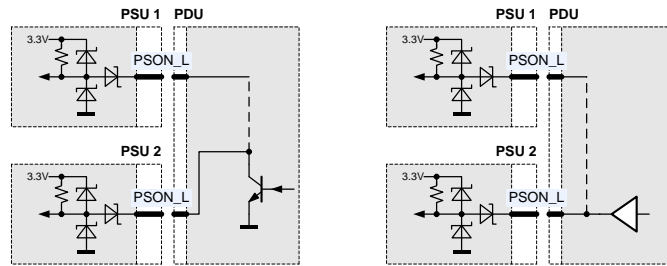

Figure 18. PSON_L connection

8.5 PWOK_H OUTPUT

The PWOK_H is an open drain output with an internal pull-up to 3.3 V indicating whether both V_{SB} and V_I outputs are within regulation. This pin is active-high.

An external pull down resistor ensures low level when there is no power supply seated. When combining PWOK_H outputs of several power supplies, circuits as shown in Figure 19 should be used.

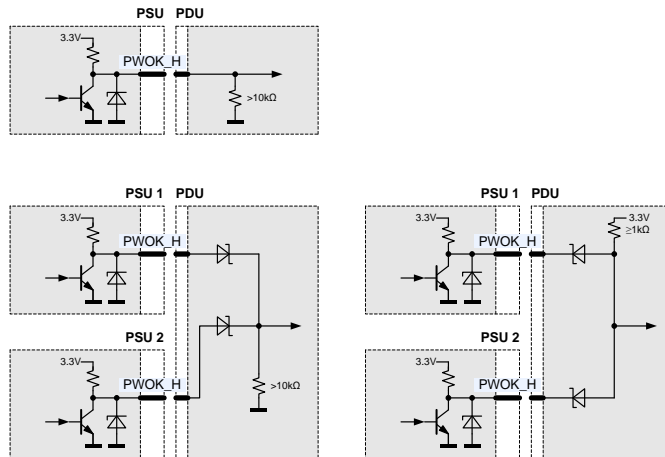

Figure 19. PWOK_H connection

8.6 HOT-STANDBY IN-/OUTPUT

The hot-standby operation is an operating mode allowing to further increase efficiency at light load conditions in a redundant power supply system. Under specific conditions one of the power supplies is allowed to disable its DC/DC stage. This will save the power losses associated with this power supply and at the same time the other power supply will operate in a load range having a better efficiency. In order to enable the hot standby operation, the HOTSTANDBYEN_H and the ISHARE pins need to be interconnected between the power supplies. A power supply will only be allowed to enter the hot-standby mode, when the HOTSTANDBYEN_H pin is high, the load current is low, see Figure 20, and the supply was allowed to enter the hot-standby mode by the system controller via the appropriate I²C command (by default disabled). The system controller needs to ensure that only one of the power supplies is allowed to enter the hot-standby mode.

If a power supply is in a fault condition, it will pull low its active-high HOTSTANDBYEN_H pin which indicates to the other power supply that it is not allowed to enter the hot-standby mode or that it needs to return to normal operation should it already have been in the hot-standby mode.

NOTE:

The system controller needs to ensure that only one of the power supplies is allowed to enter the hot-standby mode.

Figure 21 shows the achievable power loss savings when using the hot-standby mode operation. A total power loss reduction of approx. 10 W is achievable.

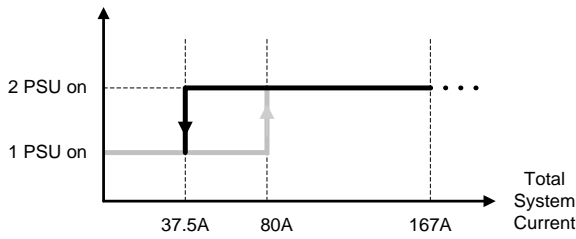

Figure 20. Hot-standby enable/disable current thresholds

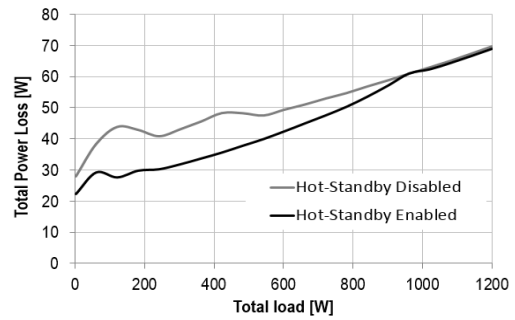

Figure 21. PSU power losses with/without hot-standby mode

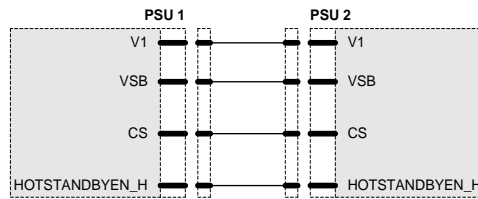

Figure 22. Recommended hot-standby configuration

8.7 PRESENT_L OUTPUT

The PRESENT_L pin is wired through a 100 Ohms resistor to internal GND within the power supply. This pin does indicate that there is a power supply present in this system slot. An external pull-up resistor has to be added within the application. Current into PRESENT_L should not exceed 5 mA to guarantee a low level voltage if power supply is seated.

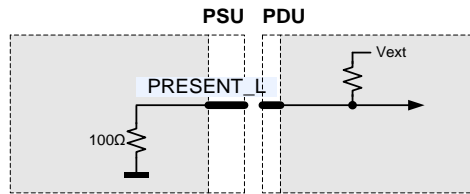

Figure 23. PRESENT_L connection

8.8 SIGNAL TIMING

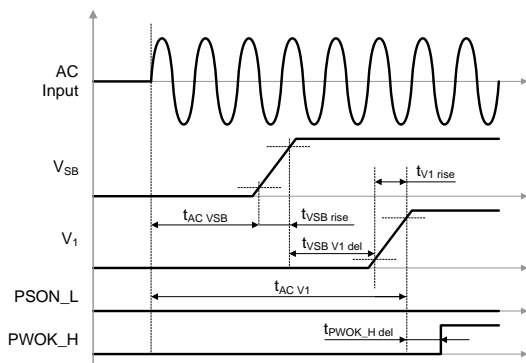

Figure 24. AC turn-on timing

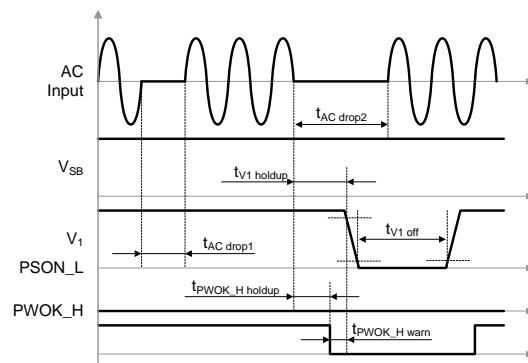

Figure 25. AC short dips

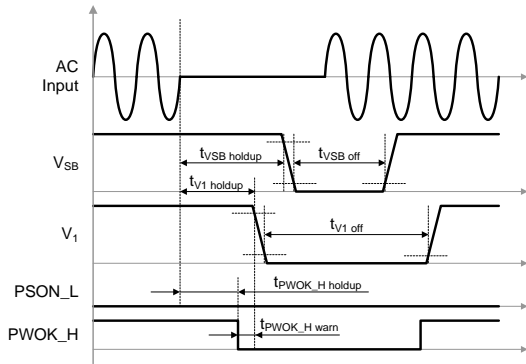

Figure 26. AC long dips

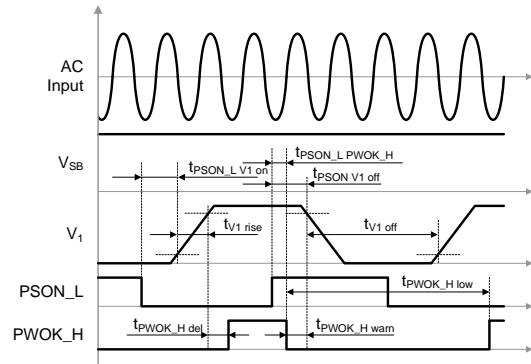

Figure 27. PSON_L turn-on/off timing

PARAMETER	DESCRIPTION / CONDITION	MIN	NOM	MAX	UNIT		
$t_{AC\ VSB}$	AC Line to 90% V_{SB}			1.5	s		
$t_{AC\ V1}$	AC Line to 90% V_1		1.5	4 ¹⁰	s		
$t_{VSB\ V1\ del}$	V_{SB} to V_1 delay	50	150	1000	ms		
$t_{V1\ rise}$	V_1 rise time	See chapter OUTPUT					
$t_{VSB\ rise}$	V_{SB} rise time	See chapter OUTPUT					
$t_{AC\ drop1}$	AC drop without V_1 leaving regulation	$0.5 \cdot I_{1\ nom}, I_{SB\ nom}$		17	ms		
		$0.7 \cdot I_{1\ nom}, I_{SB\ nom}$		13	ms		
		$I_{1\ nom}, I_{SB\ nom}$		5	ms		
$t_{AC\ drop2}$	AC drop without V_{SB} leaving regulation	$I_{1\ nom}, I_{SB\ nom}$		70	ms		
$t_{V1\ holdup}$	Loss of AC to V_1 leaving regulation	See chapter INPUT					
$t_{VSB\ holdup}$	Loss of AC to V_{SB} leaving regulation	See chapter INPUT					
$t_{PWOK_H\ del}$	Outputs in regulation to PWOK_H asserted	100	150	200	ms		
$t_{PWOK_H\ warn}$	Warning time from de-assertion of PWOK_H to V_1 leaving regulation	0.15			ms		
$t_{PWOK_H\ holdup}$	Loss of AC to PWOK_H de-asserted	$V_{1\ nom\ HL}, I_{1\ nom}, I_{SB\ nom}$		10	ms		
$t_{PWOK_H\ low}$	Time PWOK_H is kept low after being de-asserted	100			ms		
$t_{PSON_L\ V1\ on}$	Delay PSON_L active to V_1 in regulation	$C_{ext} = 0\ mF$		5	10	20	ms
$t_{PSON_L\ V1\ off}$	Delay PSON_L de-asserted to V_1 disabled	2	3	4	ms		
$t_{PSON_L\ PWOK_H}$	Delay PSON_L de-asserted to PWOK_H de-asserted		1	2	ms		
$t_{V1\ off}$	Time V_1 is kept off after leaving regulation		1		s		
$t_{VSB\ off}$	Time V_{SB} is kept off after leaving regulation		1		s		

¹⁰ At repeated ON-OFF cycles the start-up times may increase by 1s

8.9 LED INDICATOR

The front-end has one front LED showing the status of the supply. The LED is bi-colored: green and amber, and indicates AC and DC power presence and warning or fault conditions. [Table 1](#) lists the different LED status.

OPERATING CONDITION ¹¹	LED SIGNALING
No AC or AC Line in UV condition, V_{SB} not present from paralleled power supplies	Off
PSON_L High Hot-Standby Mode	Blinking Green 1 Hz
No AC or AC Line in UV condition, V_{SB} present from paralleled power supplies V_I or V_{SB} out of regulation Over temperature shutdown Output over voltage shutdown (V_I or V_{SB}) Output over current shutdown (V_I or V_{SB}) Fan error (>15%)	Solid Amber
Over temperature warning Minor fan regulation error (>5%, <15%)	Blinking Amber 1 Hz
Firmware boot loading in process	Blinking Green 2 Hz
Outputs V_I and V_{SB} in regulation	Solid Green

Table 1. LED Status

9. I²C / PMBus® COMMUNICATION

The PET front-end is a communication Slave device only; it never initiates messages on the I²C / SMBus by itself. The communication bus voltage and timing is defined in [Table 2](#) and further characterized through:

- The SDA/SCL IOs use 3.3 V logic levels
- External pull-up resistors on SDA/SCL required for correct signal edges
- Full SMBus clock speed of 100 kbps
- Clock stretching limited to 1 ms
- SCL low time-out of >25 ms with recovery within 10 ms
- Recognizes any time Start/Stop bus conditions

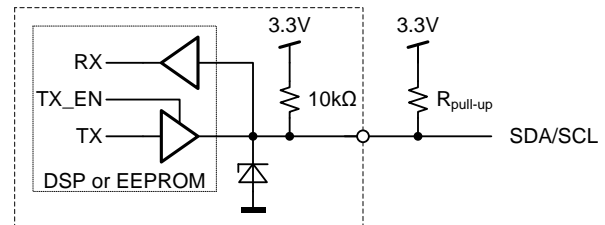

Figure 28. Physical layer of communication interface

Communication to the DSP or the EEPROM will be possible as long as the input AC voltage is provided. If no AC is present, communication to the unit is possible as long as it is connected to a life V_{SB} output (provided e.g. by the redundant unit). If only V_I is provided, communication is not possible.

¹¹ The order of the criteria in the table corresponds to the testing precedence in the controller

PARAMETER	DESCRIPTION	CONDITION	MIN	MAX	UNIT
SCL / SDA					
V_L	Input low voltage		-0.5	1.0	V
V_H	Input high voltage		2.3	3.5	V
V_{Hys}	Input hysteresis		0.15		V
V_{OL}	Output low voltage	3 mA sink current	0	0.4	V
t_r	Rise time for SDA and SCL		$20+0.1C_b^1$	300	ns
t_{of}	Output fall time $V_{IHmin} \rightarrow V_{ILmax}$	$10 \text{ pF} < C_b^1 < 400 \text{ pF}$	$20+0.1C_b^1$	250	ns
I_i	Input current SCL/SDA	$0.1 \text{ VDD} < V_i < 0.9 \text{ VDD}$	-10	10	μA
C_i	Internal Capacitance for each SCL/SDA			50	pF
f_{SCL}	SCL clock frequency		0	100	kHz
$R_{pull-up}$	External pull-up resistor	$f_{SCL} \leq 100 \text{ kHz}$		$1000 \text{ ns} / C_b^1$	Ω
t_{HDSTA}	Hold time (repeated) START	$f_{SCL} \leq 100 \text{ kHz}$	4.0		μs
t_{LOW}	Low period of the SCL clock	$f_{SCL} \leq 100 \text{ kHz}$	4.7		μs
t_{HIGH}	High period of the SCL clock	$f_{SCL} \leq 100 \text{ kHz}$	4.0		μs
t_{SUSTA}	Setup time for a repeated START	$f_{SCL} \leq 100 \text{ kHz}$	4.7		μs
t_{HDDAT}	Data hold time	$f_{SCL} \leq 100 \text{ kHz}$	0	3.45	μs
t_{SUDAT}	Data setup time	$f_{SCL} \leq 100 \text{ kHz}$	250		ns
t_{SUSTO}	Setup time for STOP condition	$f_{SCL} \leq 100 \text{ kHz}$	4.0		μs
t_{BUF}	Bus free time between STOP and START	$f_{SCL} \leq 100 \text{ kHz}$	5		ms

¹ C_b = Capacitance of bus line in pF, typically in the range of 10...400 pF

Table 2. I²C / SMBus Specification

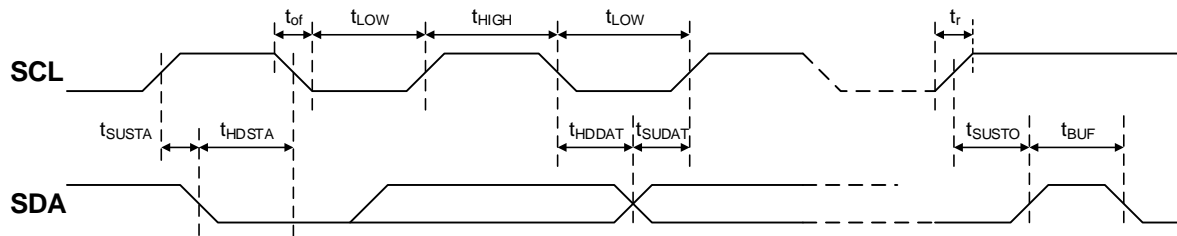

Figure 29. I²C / SMBus Timing

ADDRESS SELECTION

The address for I²C communication can be configured by pulling address input pins A2, A1 and A0 either to GND (Logic Low) or leave them open (Logic High). An internal pull up resistor will cause the A2 / A1 / A0 pin to be in High Level if left open. A fixed addressing offset exists between the Controller and the EEPROM.



Asia-Pacific
+86 755 298 85888

Europe, Middle East
+353 61 225 977

North America
+1 408 785 5200

A2	A1	A0	I2C Address ¹²	
			Controller	EEPROM
0	0	0	0xB0	0xA0
0	0	1	0xB2	0xA2
0	1	0	0xB4	0xA4
0	1	1	0xB6	0xA6
1	0	0	0xB8	0xA8
1	0	1	0xBA	0xAA
1	1	0	0xBC	0xAC
1	1	1	0xBE	0xAE

Table 3. Address and protocol encoding

9.1 SMBALERT_L OUTPUT

The SMBALERT_L signal indicates that the power supply is experiencing a problem that the system agent should investigate. This is a logical OR of the Shutdown and Warning events. It is asserted (pulled Low) at Shutdown or Warning events such as reaching temperature warning/shutdown threshold of critical component, general failure, over-current, over-voltage, under-voltage or low-speed of a failed fan. This signal may also indicate the power supply is operating in an environment exceeding the specified limits.

The SMBAlert signal is asserted simultaneously with the LED turning to solid amber or blinking amber.

PARAMETER	DESCRIPTION / CONDITION	MIN	NOM	MAX	UNIT
SMB_ALERT_L					
V_{ext}	Maximum External Pull up Voltage			12	V
I_{OH}	Maximum High Level Leakage Current	No Failure or Warning condition, $V_O = 12\text{ V}$		10	μA
V_{OL}	Output Low Level Voltage	Failure or Warning condition, $I_{sink} < 4\text{ mA}$		0.4	V
$R_{pull\ up}$	Internal Pull up Resistor to internal 3.3 V			None	
I_{OL}	Maximum Sink Current	$V_O < 0.4\text{ V}$		4	mA

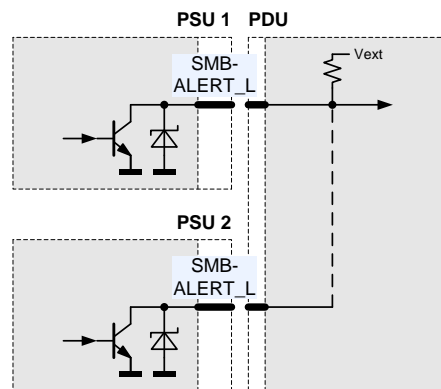

Figure 30. SMBALERT_L connection

¹² The LSB of the address byte is the R/W bit

9.2 CONTROLLER AND EEPROM ACCESS

The controller and the EEPROM in the power supply share the same I²C bus physical layer (see *Figure 31*) and can be accessed under different addresses, see ADDRESS SELECTION.

The SDA/SCL lines are connected directly to the controller and EEPROM which are supplied by internal 3.3 V.

The EEPROM provides 256 bytes of user memory. None of the bytes are used for the operation of the power supply.

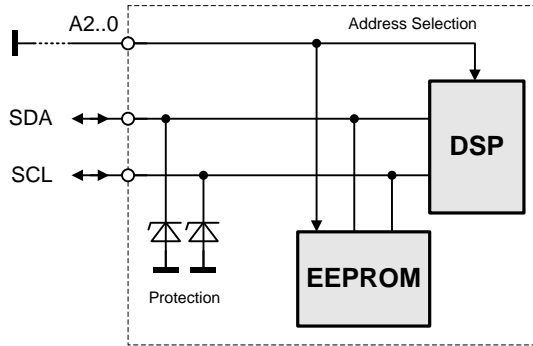

Figure 31. I²C Bus to DSP and EEPROM

9.3 EEPROM PROTOCOL

The EEPROM follows the industry communication protocols used for this type of device. Even though page write / read commands are defined, it is recommended to use the single byte write / read commands.

WRITE

The write command follows the “SMBus 1.1 Write Byte Protocol”. After the device address with the write bit cleared, the Two Byte Data Address is sent followed by the data byte and the STOP condition. A new START condition on the bus should only occur after 5ms of the last STOP condition to allow the EEPROM to write the data into its memory.

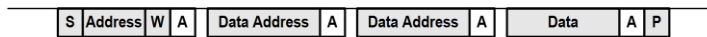

READ

The read command follows the “SMBus 1.1 Read Byte Protocol”. After the device address with the write bit cleared the two byte data address is sent followed by a repeated start, the device address and the read bit set. The EEPROM will respond with the data byte at the specified location.

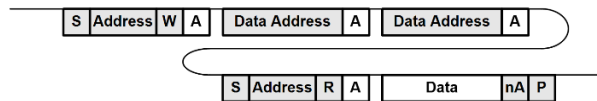

9.4 PMBus® PROTOCOL

The Power Management Bus (PMBus®) is an open standard protocol that defines means of communicating with power conversion and other devices. For more information, please see the System Management Interface Forum web site at: www.powerSIG.org.

PMBus® command codes are not register addresses. They describe a specific command to be executed.

PET2000-12-074xA supply supports the following basic command structures:

- Clock stretching limited to 1 ms
- SCL low time-out of >25 ms with recovery within 10 ms
- Recognized any time Start/Stop bus conditions

WRITE

The write protocol is the SMBus 1.1 Write Byte/Word protocol. Note that the write protocol may end after the command byte or after the first data byte (Byte command) or then after sending 2 data bytes (Word command).

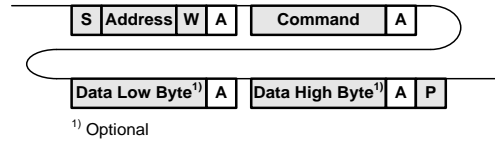

In addition, Block write commands are supported with a total maximum length of 255 bytes. See PET2000-12-074xA PMBus® Communication Manual URP.00234 for further information.

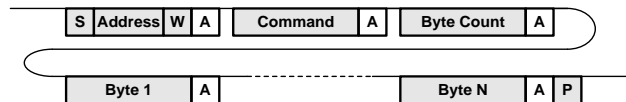
**READ**

The read protocol is the SMBus 1.1 Read Byte/Word protocol. Note that the read protocol may request a single byte or word.

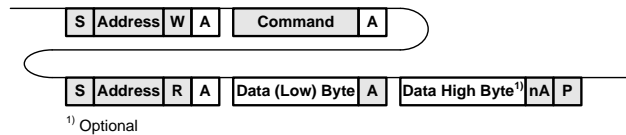

In addition, Block read commands are supported with a total maximum length of 255 bytes. See PET2000-12-074xA PMBus® Communication Manual URP.00234 for further information.

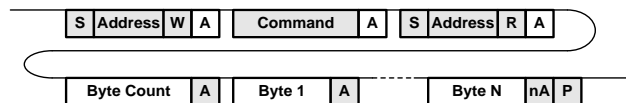
**9.5 GRAPHICAL USER INTERFACE**

Bel Power Solutions provides with its “I²C Utility” a Windows® XP/Vista/Win7 compatible graphical user interface allowing the programming and monitoring of the PET2000-12-074xA Front-End.

The utility can be downloaded on: belfuse.com/power-solutions and supports both the PSMI and PMBus® protocols.

The GUI allows automatic discovery of the units connected to the communication bus and will show them in the navigation tree. In the monitoring view the power supply can be controlled and monitored.

If the GUI is used in conjunction with the YTM.00046 Evaluation Board it is also possible to control the PSON_L pin of the power supply. Refer to BCG.00809 for YTM.00046 connection and GUI configuration.

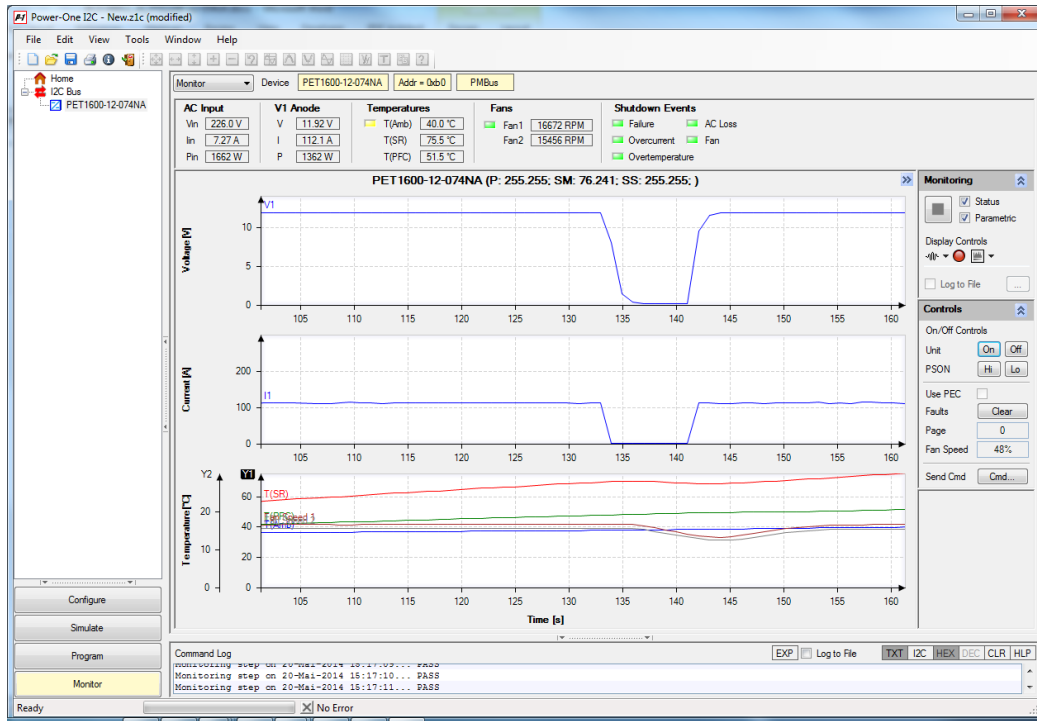

Figure 32. Monitoring dialog of the PC Utility

10. TEMPERATURE AND FAN CONTROL

10.1 FAN CONTROL

To achieve best cooling results sufficient airflow through the supply must be ensured. Do not block or obstruct the airflow at the rear of the supply by placing large objects directly at the output connector. The PET2000-12-074RA is provided with a front to rear airflow, which means the air enters on the AC-inlet side of the supply and leaves at the DC-output, while the PET2000-12-074NA is provided with a rear to front airflow, which means the air enters through the DC-output of the supply and leaves at the AC-inlet side, as shown in [Figure 33](#).

The PET2000-12-074xA supply has been designed for horizontal operation.

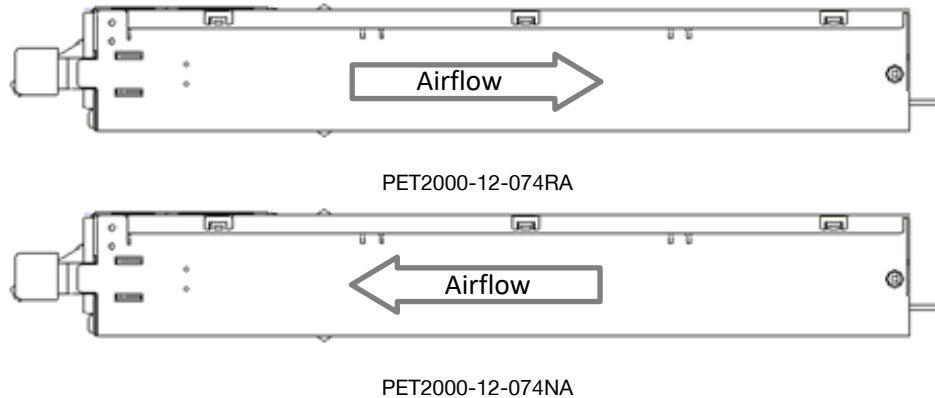

Figure 33. Airflow direction

The fan inside the supply is controlled by a microprocessor. The rpm of the fan is adjusted to ensure optimal supply cooling and is a function of output power. Three different curves are selected based on input voltage and inlet temperature. With standby output loaded the fan speed minimum is limited to ensure enough cooling of circuits providing standby power. [Figure 34](#) illustrates the programmed fan curves.

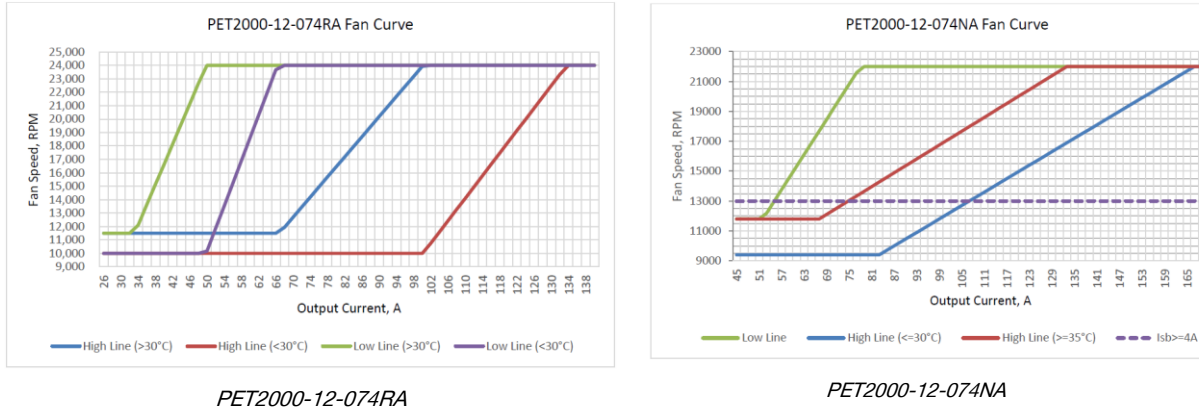

Figure 34. Fan speed vs. main output load

10.2 TEMPERATURE MONITOR AND OVER TEMPERATURE PROTECTION

PET2000-12-074xA provides access via I²C to the measured temperatures of in total 6 sensors within the power supply, see [Table 4](#). The microprocessor is monitoring these temperatures and if warning threshold of one of these sensors is reached it will set fan to maximum speed. If temperatures continue to rise above shut down threshold the main output V_o (or V_{SB} if auxiliary converter is affected) will be disabled. At the same time the warning or fault condition is signaled accordingly through LED, PWOK_H and SMBALERT_L.

TEMPERATURE SENSOR	DESCRIPTION / CONDITION	PMBUS REGISTER	WARNING THRESHOLD	SHUTDOWN THRESHOLD
PET2000-12-074RA				
Inlet Air Temperature	Sensor located on control board close to DC end of PSU	8Dh	61°C	63°C
Synchronous Rectifier	Sensor located on secondary side of DC/DC stage	8Eh	105°C	110°C
Primary Heat Sink	Sensor located on primary heat sink	8Fh	96°C	101°C
Output ORing Element	Sensor located close to output	D2h	105°C	110°C
Auxiliary Converter	Sensor located on secondary side on auxiliary rectifier	D3h	95°C	100°C
Outlet Ambient	Sensor located near output connector	D4h	85°C	90°C
PET2000-12-074NA				
Inlet Air Temperature	Sensor located on control board close to DC end of PSU	8Dh	75°C	78°C
Synchronous Rectifier	Sensor located on secondary side of DC/DC stage	8Eh	95°C	100°C
Primary Heat Sink	Sensor located on primary heat sink	8Fh	87°C	92°C
Output ORing Element	Sensor located close to output	D2h	100°C	105°C
Auxiliary Converter	Sensor located on secondary side on auxiliary rectifier	D3h	80°C	85°C
Bridge Rectifier	Sensor located on heat sink for AC rectifier	D4h	86°C	91°C

Table 4. Temperature sensor location and thresholds

10.3 MAXIMUM OUTPUT POWER VERSUS INLET TEMPERATURE FOR SAFETY COMPLIANCY

For safety compliant operation the power supply must not exceed specified operating conditions specified herein. These operating conditions ensure the input AC connector is operated within its ratings.

The different input AC connectors and regional usage is not considered in this implementation of current limitation. Therefore, it is under the responsibility of the user to ensure safety compliant operation.

10.3.1 PET2000-12-074RA

Between 0°C and 40°C power supply inlet temperature the maximum allowed output power is only depending on AC input connector type chosen, regional usage and the applied nominal input AC voltage. Above 40°C the maximum output power is further reduced with rising temperature. *Figure 35* to *Figure 38* illustrate these maximum current and power levels.

The mentioned power levels are related to main output power only, in addition the standby output can be operated up to 5 A with derating to 3 A as shown in *Figure 37*.

Above 55°C the power supply is adjusting the current limit level $I_{I OC Slow}$ depending on input voltage range (100-127 VAC or 200-240 VAC) and inlet temperature, as shown in *Figure 38* to protect the power supply from excessive component temperatures.

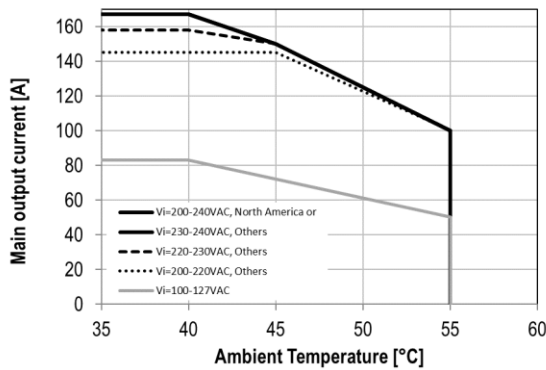

Figure 35. Maximum I_1 PET2000-12-074RA (IEC 60320-C14)

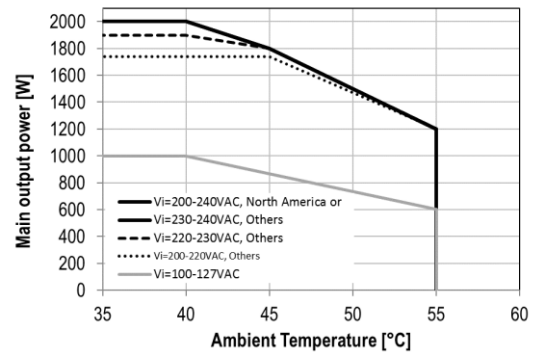

Figure 36. Maximum P_1 PET2000-12-074RA (IEC 60320-C14)

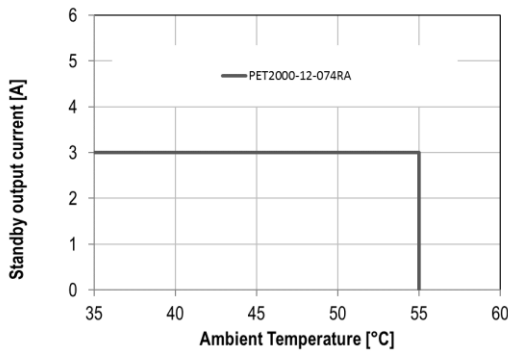

Figure 37. Maximum ISB

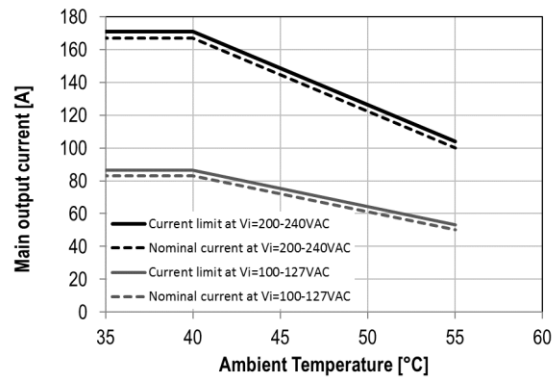

Figure 38. Current limitation vs temperature

10.3.2 PET2000-12-074NA

Between 0°C and 55°C power supply inlet temperature the maximum allowed output power is only depending on AC input connector type chosen, regional usage and the applied nominal input AC voltage. Above 55°C the maximum output power is further reduced with rising temperature. Figure 39 to Figure 44 illustrate these maximum current and power levels.

The mentioned power levels are related to main output power only, in addition the standby output can be operated up to 5 A with derating to 3 A as shown in Figure 45.

Above 55°C the power supply is adjusting the current limit level $I_{1 OC Slow}$ depending on input voltage range (100-127 VAC or 200-240 VAC) and inlet temperature, as shown in Figure 46.

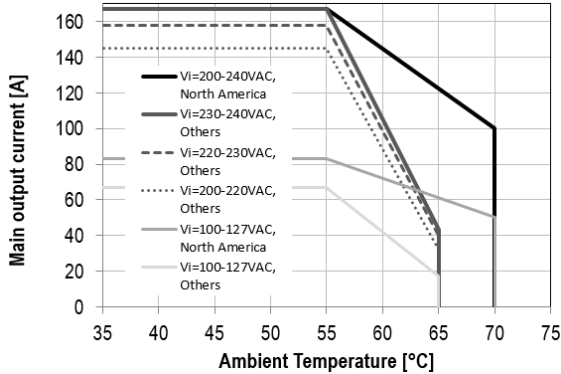

Figure 39. Maximum I_1 PET2000-12-074NA (IEC 60320-C14)

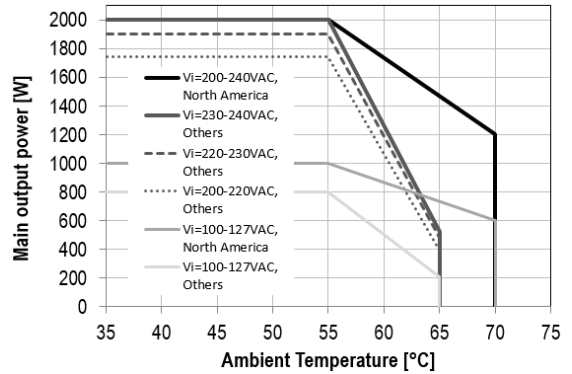

Figure 40. Maximum P_1 PET2000-12-074NA (IEC 60320-C14)

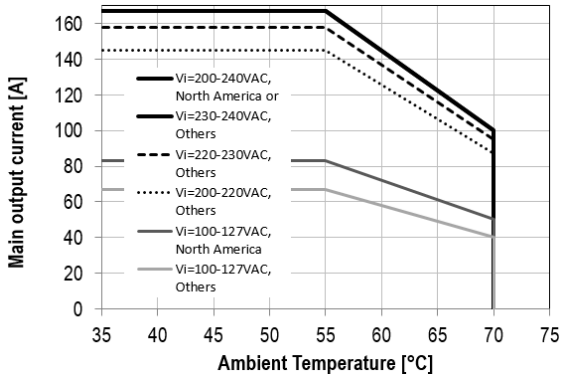

Figure 41. Maximum I_1 PET2000-12-074NAC (IEC 60320-C16)

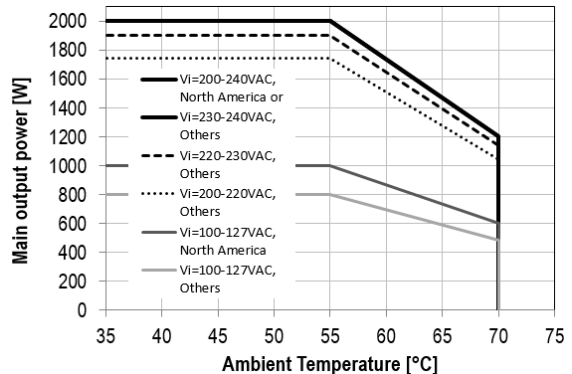

Figure 42. Maximum P_1 PET2000-12-074NAC (IEC 60320-C16)

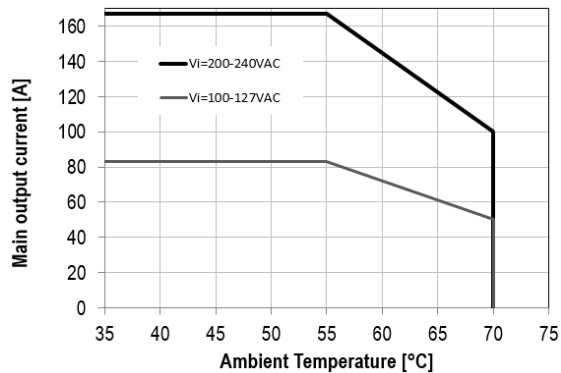

Figure 43. Maximum I_1 PET2000-12-074NAA (Anderson Saf-D-Grid®)

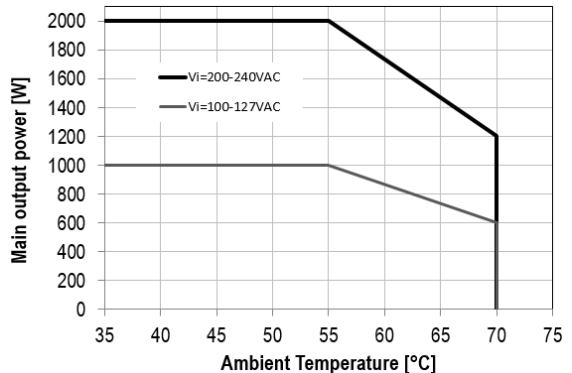

Figure 44. Maximum P_1 PET2000-12-074NAA (Anderson Saf-D-Grid®)

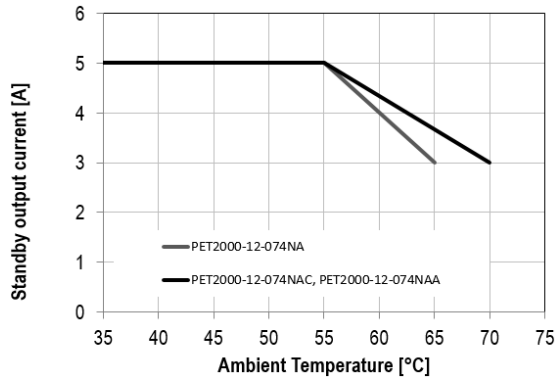

Figure 45. Maximum ISB

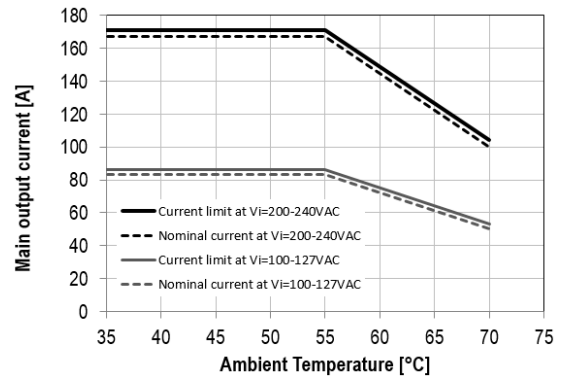

Figure 46. Current limitation vs temperature

11. ELECTROMAGNETIC COMPATIBILITY

11.1 IMMUNITY

PARAMETER	DESCRIPTION / CONDITION	CRITERION
ESD Contact Discharge	IEC / EN 61000-4-2, ±8 kV, 25+25 discharges per test point (metallic case, LED, connector body)	A
ESD Air Discharge	IEC / EN 61000-4-2, ±15 kV, 25+25 discharges per test point (non-metallic user accessible surfaces)	A
Radiated Electromagnetics Filed	IEC / EN 61000-4-3, 10 V/m, 1 kHz/80% Amplitude Modulation, 1µs Pulse Modulation, 10 kHz ... 2 GHz	A
Burst	IEC / EN 61000-4-4, Level 3 AC port ±2 kV, 1 minute	A
Surge	IEC / EN 61000-4-5, Level 3 Line to Earth: ±2 kV Line to Line: ±1 kV	A
RF Conducted Immunity	IEC / EN 61000-4-6, Level 3, 10 Vrms, CW, 0.1 ... 80 MHz	A
Voltage Dips and Interruptions	IEC / EN 61000-4-11 Vi 230VAC / 50 Hz, 90% load, Phase 0°, Dip 100% , duration 10 ms Vi 200VAC / 50 Hz, 70% load, Phase 0°, Dip 30% , duration 500 ms Vi 200VAC / 50 Hz, 100% load, Phase 0°, Dip 20% , duration 10 s	Vi: A, V _{SG} : A Vi: A, V _{SG} : A Vi: A, V _{SG} : A

11.2 EMISSION

PARAMETER	DESCRIPTION / CONDITION	CRITERION
Conducted Emission	EN 55022 / CISPR 22: 0.15 ... 30 MHz, QP and AVG, single power supply	Class A 6 dB margin
	EN 55022 / CISPR 22: 0.15 ... 30 MHz, QP and AVG, 2 power supplies in a system	Class A
Radiated Emission	EN 55022 / CISPR 22: 30 MHz ... 1 GHz, QP, single power supply	Class A 6 dB margin
	EN 55022 / CISPR 22: 30 MHz ... 1 GHz, QP, 2 power supplies in a system	Class A
Harmonic Emissions	IEC 61000-3-2, Vi = 115 VAC / 60 Hz & 230 VAC / 50 Hz, 100% Load	Class A
AC Flicker	IEC 61000-3-3, Vi = 230 VAC / 50Hz, 100% Load	Pass
Acoustical Noise	Distance at bystander position, 25°C, 50% Load	65 dBA

12. SAFETY / APPROVALS

Maximum electric strength testing is performed in the factory according to IEC/EN 60950, and UL 60950. Input-to-output electric strength tests should not be repeated in the field. Bel Power Solutions will not honor any warranty claims resulting from electric strength field tests.

PARAMETER	DESCRIPTION / CONDITION	NOTES
Agency Approvals	Approved to latest edition of the following standards: UL/CSA60950-1, IEC60950-1 and EN60950-1. NEMKO NO86275, EAC NO 0230738, COC	Approved
Grade of Insulation	Input (L/N) to chassis (PE) Input (L/N) to output Output to chassis	Basic Reinforced None (Direct connection)
Creepage / Clearance	Primary (L/N) to chassis (PE) Primary to secondary	
Electrical Strength Test	Input to chassis Input to output (tested by manufacturer only)	Min. 2121 VDC 4242 VDC

13. ENVIRONMENTAL

PARAMETER	DESCRIPTION / CONDITION	MIN	NOM	MAX	UNIT
T_A Ambient Temperature	Up to 1'000 m ASL	0		+40 +55*	°C
	Linear derating from 1'000 to 3'048 m ASL			+35 +45*	°C
$T_{A\ ext}$ Extended Temp. Range	Reduced output power ¹³ , up to 1'000 m ASL			+55 +70*	°C
	Linear derating from 1'000 to 3'048 m ASL			+50 +60*	
T_S Storage Temperature	Non-operational	-20		+70	°C
	Operational, above Sea Level	-		3'048	m
Altitude	Operational, above Sea Level	-		10'600	m
	Non-operational, above Sea Level	-			
Shock, operational	Half sine, 11ms, 10 shocks per direction,			1	g peak
Shock, non-operational	6 directions			30	g peak
Vibration, sinusoidal, operational	IEC/EN 60068-2-6, sweep 5 to 500 to 5 Hz,			1	g peak
Vibration, sinusoidal, non-operational	1 octave/min, 5 sweep per axis			4	g peak
Vibration, random, non-operational	IEC/EN 60068-2-64, 5 to 500 Hz, 1 hour per axis			0.025	g ² /Hz

* Max temperature values for PET2000-12-074NA model.

14. RELIABILITY

PARAMETER	DESCRIPTION / CONDITION	MIN	NOM	MAX	UNIT
$MTBF$ Mean time to failure	$T_A = 25^\circ\text{C}$, according Telcordia SR-332, issue 3, GB, confidence level = 90%	860			kh

15. MECHANICAL

PARAMETER	DESCRIPTION / CONDITION	MIN	NOM	MAX	UNIT
Dimensions	Width		73.5		mm
	Height		40.0		mm
	Depth		265.0		mm
m Weight			1.1		kg

¹³ See chapter 10.3

15.1 OUTLINE PET2000-12-074xA, PET2000-12-074xAC

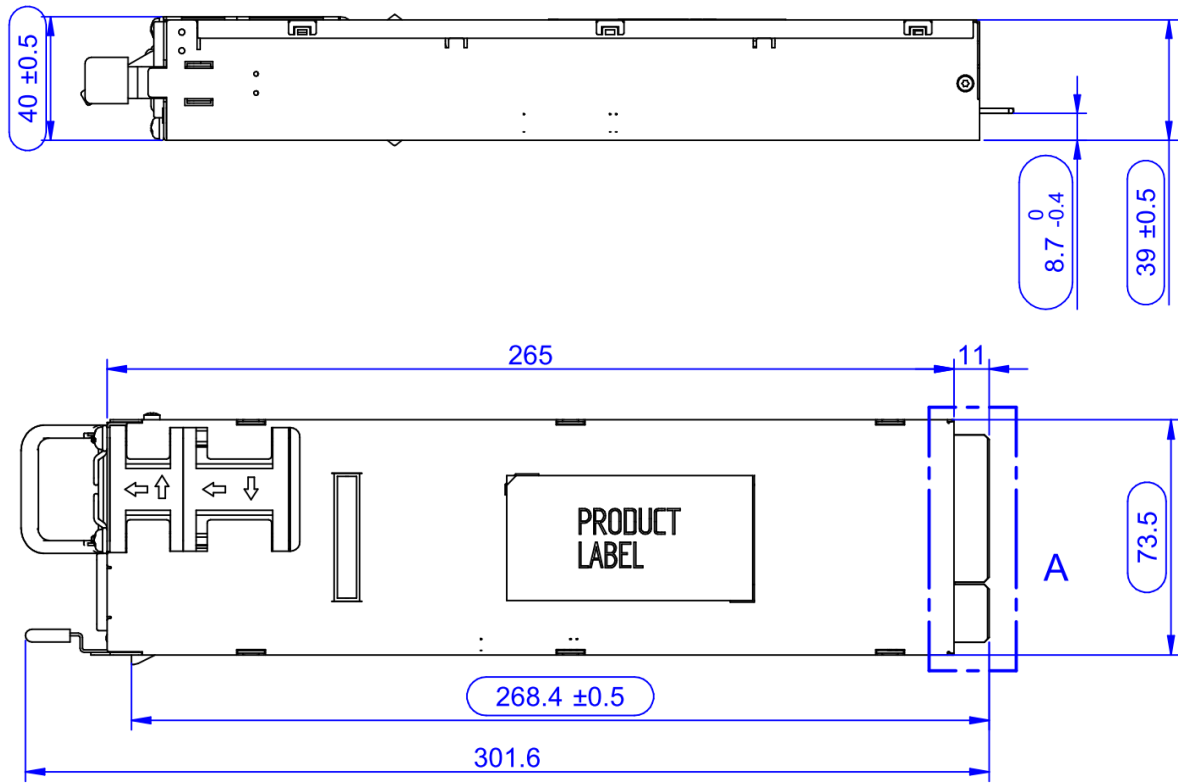

Figure 47. Top and side view

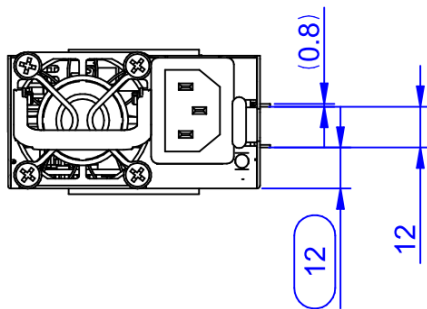

Figure 48. Front view

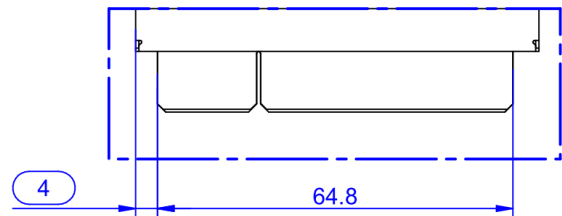

Figure 49. Rear view

15.2 OUTLINE PET2000-12-074NAA

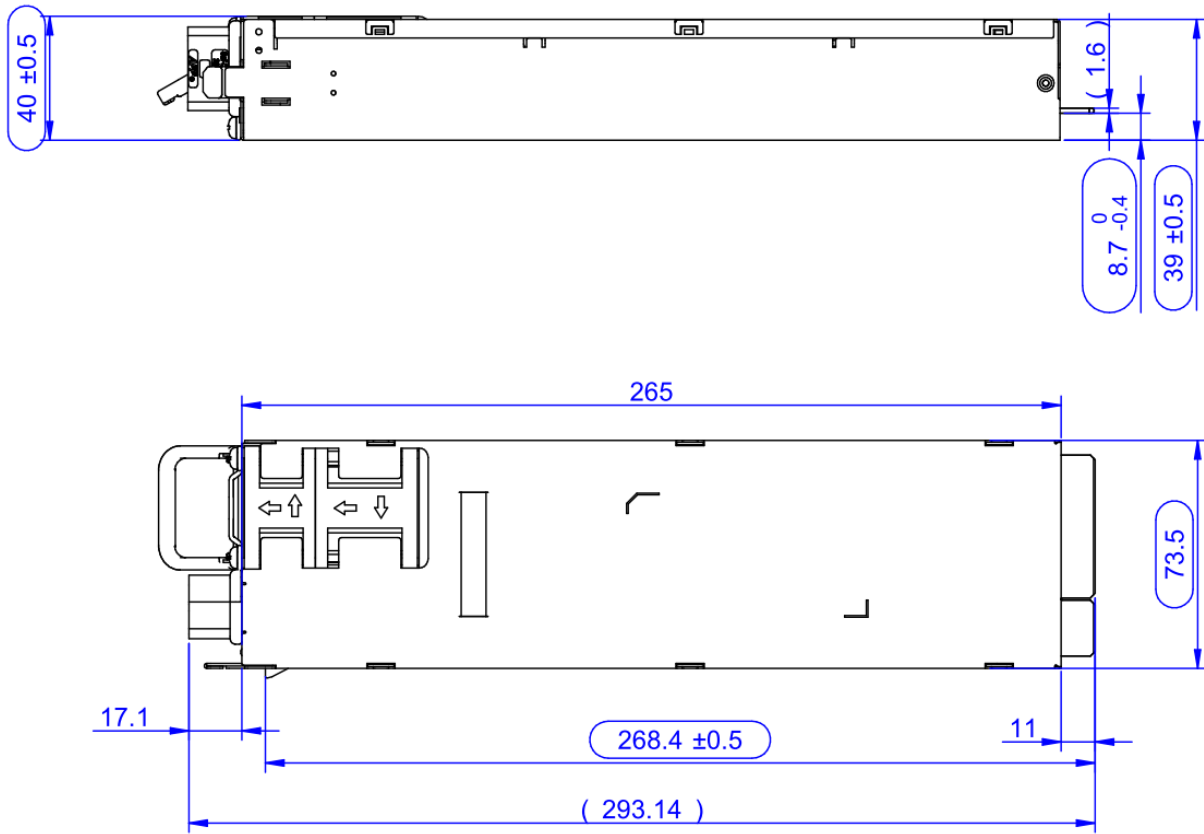

Figure 50. Top and side view

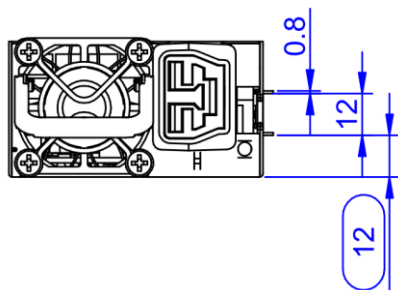

Figure 51. Front view

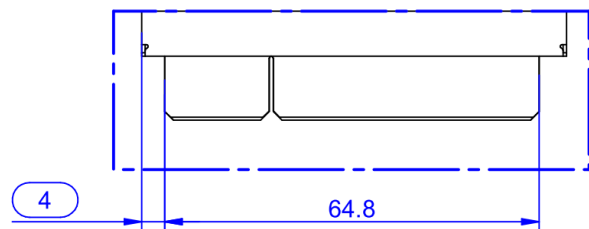

Figure 52. Detail A

15.3 OPTION OF ADDING KEYING SCREW

A thread added to the side of the PET2000-12-074xA allows the user to add a screw to prevent the PET2000-12-074xA from being inserted into systems using other card edge connector types with the same power supply width and height. In such case, systems using PET2000-12-074xA must have a slot of $\varnothing 6$ mm x 14 mm implemented to allow PET2000-12-074xA to be inserted. The maximum size of the screw head is $\varnothing 6$ mm and height 2.12 mm.

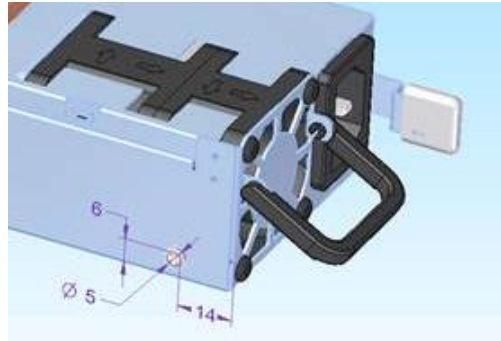

Figure 53. Polarizing screw

15.4 OUTPUT CONNECTOR PIN LOCATIONS

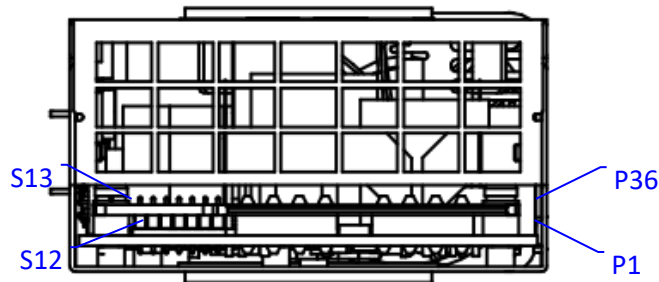

Figure 54. Rear view

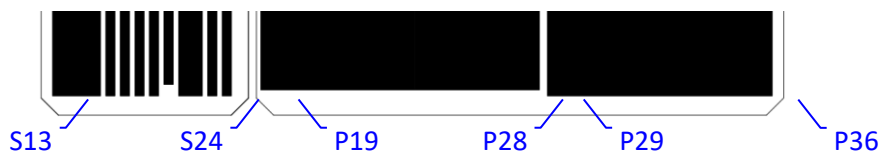

Figure 55. Card edge PCB top view

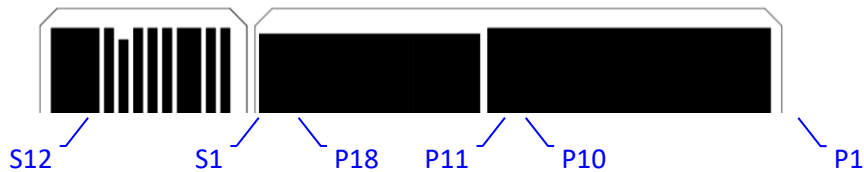

Figure 56. Card edge PCB bottom view

16. CONNECTORS

PARAMETER	DESCRIPTION / CONDITION	MIN	NOM	MAX	UNIT
AC inlet	PET2000-12-074xA : IEC 60320-C14 PET2000-12-074xAC : IEC 60320-C16 PET2000-12-074NAA: Anderson Saf-D-Grid®, P/N 2006G1				
AC cord requirement	Wire size	16			AWG
Output connector	36 Power- + 24 Signal-Pins PCB card edge Manufacturer: FCI Electronics				
Mating output connector	Manufacturer P/N: 10130248-005LF (see <i>Figure 59</i> for option x) Bel Power Solutions P/N: ZES.00678				

16.1 MATING OUTPUT CONNECTOR SPECIFICATION

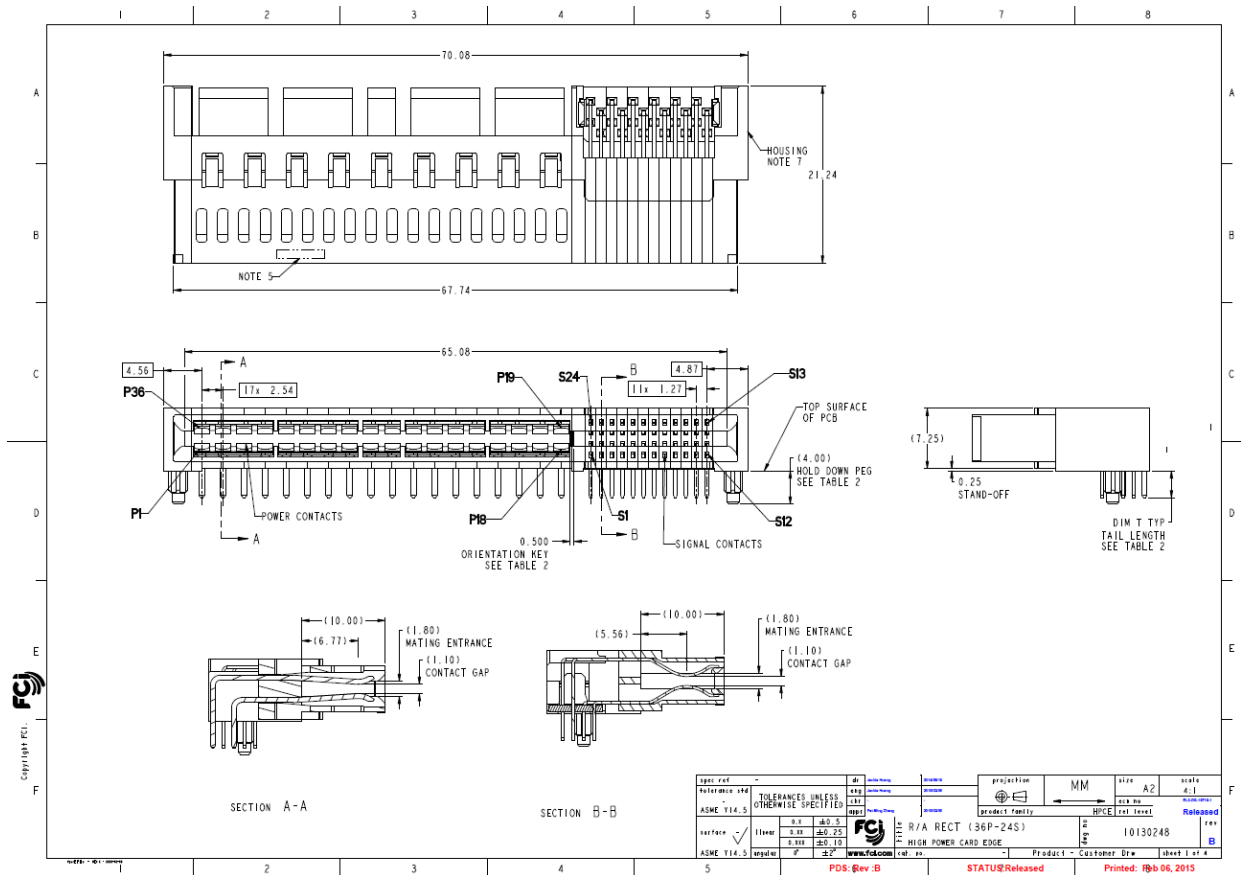

Figure 57. Mating connector drawing page 1

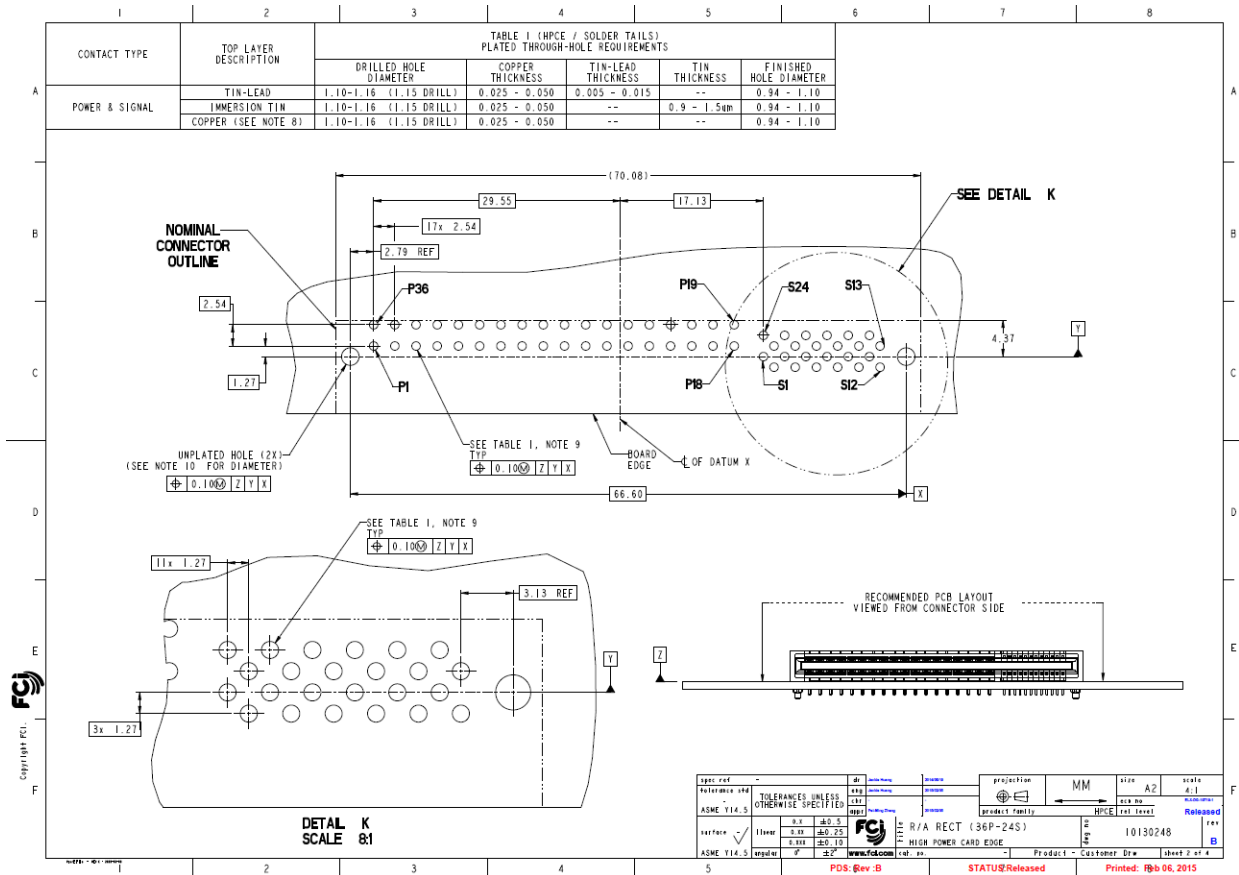

Figure 58. Mating connector drawing page 2

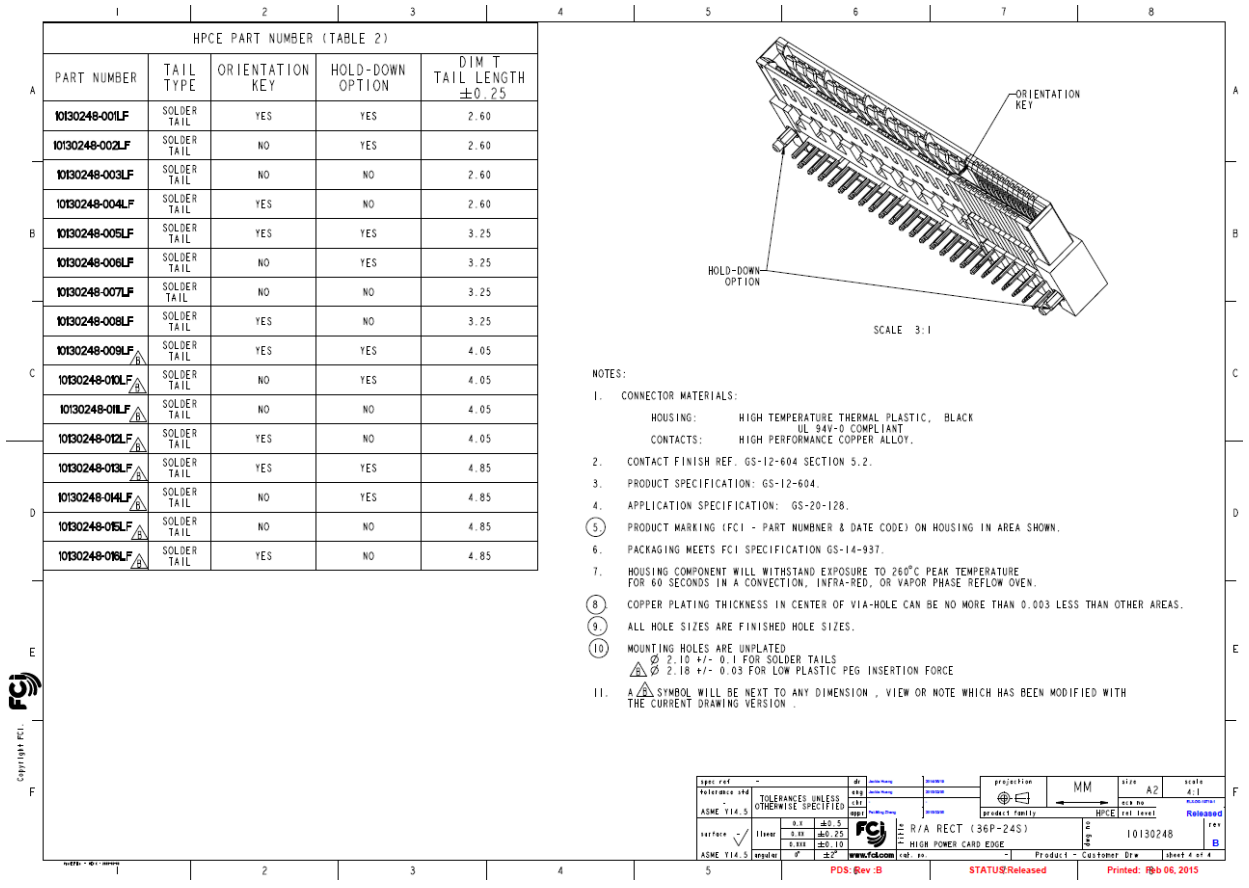

Figure 59. Mating connector drawing page 3



16.2 MATING OUTPUT CONNECTOR SPECIFICATION

PIN	SIGNAL NAME	DESCRIPTION	Mating Sequence ¹⁴
P1 ~ P10	GND	Power and signal ground (return)	1
P29 ~ P36	GND		
P11 ~ P18	V1	+12 VDC main output	2
P19 ~ P28	V1		
S1	A0	I ² C address selection input	2
S2	A1		
S3, S4	VSB	+12 V Standby positive output (as pins S3, S4)	2
S5	HOTSTANDBYEN_H	Hot standby enable signal, active-high	2
S6	ISHARE	Analog current share bus	2
S7	Reserved	For future use, do not connect	2
S8	PRESENT_L	Power supply seated, active-low	3
S9	A2	I ² C address selection input	2
S10 ~ S15	GND	Power and signal ground (return)	2
S16	PWOK_H	Power OK signal output, active-high	2
S17	V1_SENSE	Main output positive sense	2
S18	V1_SENSE_R	Main output negative sense	2
S19	SMB_ALERT_L	SMB Alert signal output, active-low	2
S20	PERSON_L	Power supply on input, active-low	3
S21, S22	VSB	+12 V Standby positive output (as pins S3, S4)	2
S23	SCL	I ² C clock signal line	2
S24	SDA	I ² C data signal line	2

Table 5. Output connector pin assignment

¹⁴ 1 = First, 3 = Last, given by different card edge finger pin lengths and mating connector pin arrangement

17. ACCESSORIES

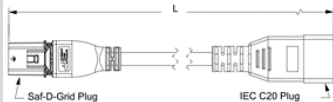
ITEM	DESCRIPTION	ORDERING PART NUMBER	SOURCE
	<p>I²C Utility Windows XP/Vista/7 compatible GUI to program, control and monitor Front-End power supplies (and other I²C units)</p>	ZS-00130	belfuse.com/power-solutions
	<p>Evaluation Board Connector board to operate PET2000-12-074xA. Includes an on-board USB to I²C converter (use I²C Utility as desktop software).</p>	YTM.00046	belfuse.com/power-solutions
	<p>AC cable for PET2000-12-074NAA Anderson Saf-D-Grid® receptacle to IEC 60320-C20 plug, 14 AWG, 2 m, Anderson P/N 2052KH2</p>	TBD	

For more information on these products consult: tech.support@psbel.com

NUCLEAR AND MEDICAL APPLICATIONS - Products are not designed or intended for use as critical components in life support systems, equipment used in hazardous environments, or nuclear control systems.

TECHNICAL REVISIONS - The appearance of products, including safety agency certifications pictured on labels, may change depending on the date manufactured. Specifications are subject to change without notice.