



# TET4000-48-069RA

## 4000 W AC-DC Front-End Power Supply

Bel Power Solutions **TET4000-48-069RA** is a 4000 Watt ACDC power-factor-corrected (PFC) and DC-DC power supply that converts standard AC mains power or high voltage DC bus voltages into a main output of 48 VDC (42 – 58 VDC) for supplying 48 VDC power distribution in high performance and reliability data center equipment, servers, routers, and network switches.

The TET4000-48-069RA meets international safety standards and displays the CE-Mark for the European Low Voltage Directive (LVD).



### Key Features & Benefits

- Best-in-class efficiency of up to 98%
- Wide input voltage range: Full power available at 200-277 VAC or 240-380 VDC, reduced output power at 100-200 VAC
- AC input with power factor correction, usable also with high voltage DC
- 4000 W main output with programmable voltage set-point of 42-58 VDC
- Optional Standby output 12 VDC / 60 W
- One single rear side connector for input and output power and signaling
- Parallel operation with active digital current sharing through CAN bus
- Hot-plug capable
- High density design: 44 W/in<sup>3</sup>
- Small form factor: 69 x 40.6 x 528 mm
- Full digital controls for improved performance
- CAN communication interface for monitoring, control, and firmware update via bootloader, optional I<sup>2</sup>C communication instead of CAN bus foreseen
- Overtemperature, output overvoltage and overcurrent protection
- 2 Status LEDs: AC OK and DC OK with fault signaling
- Safety-approved to IEC/EN 60950-1 and UL/CSA 60950-1 2nd ed.
- RoHS Compliant
- US Patent Pending



### Applications

- Data Center
- High Performance Servers
- Routers
- Switches



**bel** POWER SOLUTIONS & PROTECTION

a bel group

[belfuse.com/power-solutions](http://belfuse.com/power-solutions)

## 1. ORDERING INFORMATION

TET	4000	-	48	-	069	R	A	Option Code
Product Family	Power Level	Dash	V1 Output	Dash	Width	Airflow	Input	Blank
TET Front-Ends	4000 W		48 V		69 mm	R: Reversed <sup>1</sup>	A: AC	Standard model

## 2. OVERVIEW

The TET4000-48-069RA is a fully DSP controlled, highly efficient front-end power supply. It incorporates resonant-soft-switching technology and highly integrated conversion stages to reduce component stresses, providing increased system reliability, very high efficiency and high power density. With a wide input operating voltage range and minimal linear derating of output power with respect to ambient temperature, the TET4000-48-069RA maximizes power availability in demanding server, switch, and router applications. The power supply is fan cooled and ideally suited for server integration with a matching airflow path.

The PFC stage is digitally controlled using a state-of-the-art digital signal processing algorithm to guarantee best efficiency and unity power factor over a wide operating range when using AC input voltage. When operated with high voltage DC the PFC circuit is still in operation, but input current is controlled to be DC.

The DC-DC stage uses soft switching resonant techniques in conjunction with synchronous rectification. An active OR-ing device on the output ensures no reverse load current and renders the supply ideally suited for operation in redundant power systems.

The optional always-on +12V standby output provides power to external power distribution and management controllers. Its protection with an active OR-ing device provides for maximum reliability.

Status information is provided with front-panel LEDs. In addition, the power supply can be monitored and controlled (i.e. fan speed setpoint) via CAN communication interface. It allows full monitoring of the supply, including input and output voltage, current, power, and inside temperatures. The same CAN bus supports the bootloader to allow field update of the firmware in the DSP controllers.

Cooling is managed by a fan, controlled by the DSP controller. The fan speed is adjusted automatically depending on the actual power demand and supply temperature and can be overridden through the CAN bus. Availability of an optional I2C bus instead of CAN bus is foreseen.

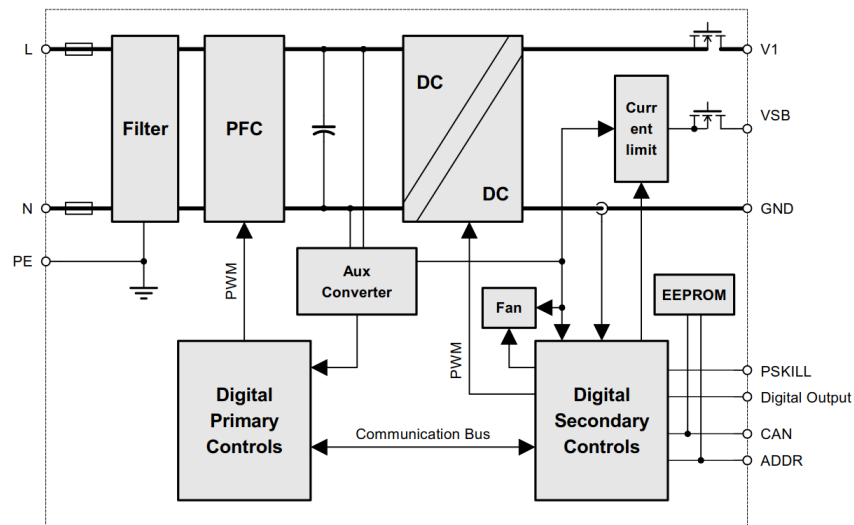

Figure 1. TET4000-48-069RA Block Diagram

<sup>1</sup> Front to Rear

### 3. ABSOLUTE MAXIMUM RATINGS

Stresses in excess of the absolute maximum ratings may cause performance degradation, adversely affect long-term reliability, and cause permanent damage to the power supply.

PARAMETER	CONDITIONS / DESCRIPTION	MIN	MAX	UNITS
$V_{i,maxc}$	Maximum Input		300 400	VAC VDC

### 4. INPUT

General Condition:  $T_A = 0...45$  °C unless otherwise specified.

PARAMETER	DESCRIPTION / CONDITION	MIN	NOM	MAX	UNIT		
$V_{i,AC,nom}$	Rated AC Input Voltage	Rated AC Input Voltage		100	230	277	VAC
$V_{i,AC,operating}$	AC Input Voltage Range	Operating AC Input Voltage ( $V_{i,AC,min}$ to $V_{i,AC,max}$ )		90		300	VAC
$V_{i,AC,HL}$	High line AC Input Voltage	AC Input Voltage Range with full output power		180		300	VAC
$V_{i,AC,Red}$	Derated AC Input Voltage	AC Input Voltage Range with reduced output power.		90		180	VAC
$I_{i,max}$	Max Input Current	$V_{i,AC} > 200$ VAC or $V_{i,DC} > 200$ VDC				23	$A_{rms}$
$I_{i,p}$	Inrush Current Limitation	$V_{i,AC,min}$ to $V_{i,AC,max}$ or $V_{i,AC,min}$ to $V_{i,AC,max}$ , $T_{NTC} = 25$ °C				50	$A_p$
$F_i$	Input Frequency	47	50/60	63			Hz
PF	Power Factor	$V_{i,AC,nom}$ , 50Hz, $I_1 > 0.3 I_{1,nom}$		0.96			W/VA
$V_{i,AC,on}$	Turn-on AC Input Voltage <sup>2</sup>	Ramping up		80		87	VAC
$V_{i,AC,off}$	Turn-off AC Input Voltage	Ramping down		73		85	VAC
$\eta$	Efficiency	$V_i = 277$ VAC, $0.1 \cdot I_{1,nom}$ , $I_{SB} = 0A$ , $V_{x,nom}$ , $T_A = 25$ °C				94.6	%
		$V_i = 277$ VAC, $0.2 \cdot I_{1,nom}$ , $I_{SB} = 0A$ , $V_{x,nom}$ , $T_A = 25$ °C				96.6	
		$V_i = 277$ VAC, $0.5 \cdot I_{1,nom}$ , $I_{SB} = 0A$ , $V_{x,nom}$ , $T_A = 25$ °C				97.4	
		$V_i = 277$ VAC, $I_{1,nom}$ , $I_{SB} = 0A$ , $V_{x,nom}$ , $T_A = 25$ °C				96.5	
$T_{hold}$	Hold-up Time	After last AC zero crossing, $V_1 > 41V$ , $V_{i,AC,nom}$ or $V_{i,DC,nom}$ , $P_{1,nom}$		15			ms

#### 4.1. INPUT FUSE

Fast-acting 30 A input fuses (6.3 × 32 mm) in series with both the L- and N-line inside the power supply protect against severe defects. The fuses are not accessible from the outside and are therefore not serviceable parts.

#### 4.2. INRUSH CURRENT

The AC-DC power supply exhibits an X capacitance of 5.8  $\mu$ F, resulting in a low and short peak current, when the supply is connected to the mains. The internal bulk capacitors will be charged through NTC resistors which will limit the inrush current.

#### NOTE:

Do not repeat plug-in / out operations below 30 sec interval time, or else the internal in-rush current limiting device (NTC) may not sufficiently cool down and excessive inrush current may result.

<sup>2</sup> The Front-End is provided with a minimum hysteresis of 3 V during turn-on and turn-off within the ranges

### 4.3. INPUT UNDER-VOLTAGE

If the input voltage (either AC or DC) stays below the input under-voltage lockout threshold  $V_{iAC\ on}$  or  $V_{iDC\ on}$ , the supply will be inhibited. Once the input voltage returns within the normal operating range, the supply will return to normal operation again.

### 4.4. POWER FACTOR CORRECTION

Power factor correction (PFC) is achieved by controlling the input current waveform synchronously with the input voltage. A fully digital controller is implemented giving outstanding PFC results over a wide input voltage and load range. The input current will follow the shape of the input voltage. If, for instance, the input voltage has a trapezoidal waveform, then the current will also show a trapezoidal waveform.

### 4.5. EFFICIENCY

The high efficiency is achieved by using state-of-the-art silicon power devices in conjunction with soft-transition topologies minimizing switching losses and a full digital control scheme. Synchronous rectifiers on the output reduce the losses in the high current output path. The rpm of the fan is digitally controlled to keep all components at an optimal operating temperature regardless of the ambient temperature and load conditions. *Figure 2* shows the measured efficiency with AC input voltage applied, with standby output at zero load.

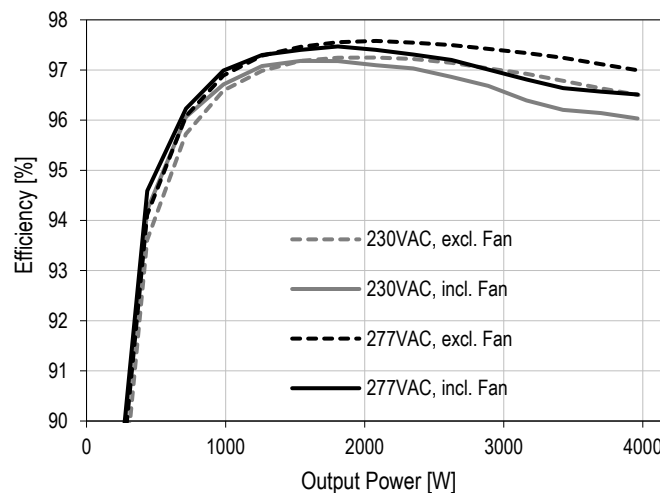

Figure 2. Typical Efficiency vs. Load Current

## 5. OUTPUT

General Condition:  $T_A = 0 \dots 45 \text{ }^\circ\text{C}$  unless otherwise noted.

PARAMETER	DESCRIPTION / CONDITION	MIN	NOM	MAX	UNIT	
<b>Main Output V1</b>						
$V_{1 \text{ nom}}$	Nominal Output Voltage	$0.5 \cdot I_{1 \text{ nom}}, T_A \leq 45^\circ\text{C}$		54.5	VDC	
$V_{1 \text{ prg}}$	Programmable Output Voltage Range	$0.5 \cdot I_{1 \text{ nom}}, T_A \leq 45^\circ\text{C}$		48	58	VDC
$V_{1 \text{ set}}$	Output Setpoint Accuracy	$0.5 \cdot I_{1 \text{ nom}}, T_A \leq 45^\circ\text{C}$		-0.5	+0.5	% $V_{1 \text{ nom}}$
$dV_{1 \text{ tot}}$	Total Regulation	$V_{i \text{ min}}$ to $V_{i \text{ max}}, 0$ to $100\% I_{1 \text{ nom}}, T_{a \text{ min}}$ to $T_{a \text{ max}}$		-2	+2	% $V_{1 \text{ nom}}$
$P_{1 \text{ nom}}$	Nominal Output Power	$V_{i \text{ AC/DC HL}}, T_A \leq 45^\circ\text{C}$		4000	W	
		$V_{i \text{ AC/DC HL}}, T_A = 55^\circ\text{C}$		3000	W	
$I_{1 \text{ nom}}$	Nominal Output Current	$V_{i \text{ AC/DC HL}}, T_A \leq 45^\circ\text{C}, V_1 = 54.5\text{V}$		73	ADC	
		$V_{i \text{ AC/DC HL}}, T_A = 55^\circ\text{C}$		63	ADC	
$P_{1 \text{ red}}$	Available Output Power at $V_{in} < 180\text{V}$	$V_{i \text{ AC Red}}, T_A \leq 45^\circ\text{C}$		25Arms*Vin - 400W		
$P_{1 \text{ red}}$	Low Line Output Power	$V_i = 120 \text{ VAC}, T_A \leq 45^\circ\text{C}$		2600	W	
$I_{1 \text{ os}}$	Short time over load current, Maximum duration 5 ms	$V_{i \text{ AC/DC HL}}$ . Reduced proportional to power limit.		83	ADC	
$V_{1 \text{ pp}}$	Output Ripple Voltage	20 MHz BW		500	mVpp	
$dV_{1 \text{ Load}}$	Load Regulation	$V_i = V_{i \text{ nom}}, 0 - 100\% I_{1 \text{ nom}}$		-10	mV/A	
$dV_{1 \text{ Line}}$	Line Regulation	$V_i = V_{i \text{ AC/DC min}} \dots V_{i \text{ AC/DC max}}$		0	mV	
$P_{1 \text{ Lim}}$	Power Limitation	$V_{i \text{ AC/DC HL}}, T_A \leq 45^\circ\text{C}, V_1 \geq 48.0 \text{ V}$		4000	W	
		$V_{i \text{ AC/DC HL}}, T_A = 55^\circ\text{C}, V_1 \geq 48.0 \text{ V}$		3100		
$I_{1 \text{ Lim}}$	Current Limitation	$V_{i \text{ AC/DC HL}}, T_A \leq 45^\circ\text{C}, V_1 = 54.5\text{V}$		73	ADC	
		$V_{i \text{ AC/DC HL}}, T_A = 55^\circ\text{C}$		63	ADC	
$dI_{\text{share}}$	Current Sharing	Deviation from $I_{1 \text{ tot}} / N, I_1 > 25\% I_{1 \text{ nom}}$		-2	+2	ADC
$dV_{\text{dyn}}$	Dynamic Load Regulation	$\Delta I_1 = 50\% I_{1 \text{ nom}}, I_1 = 10 \dots 100\% I_{1 \text{ nom}},$ $dI_1/dt = 1\text{A}/\mu\text{s}, f = 2 \dots 50 \text{ Hz},$ Duty cycle = 20 ... 80%		-2	2	V
$T_{\text{rec}}$	Recovery Time	Within 1% of $V_1$ final steady state $I_1 = 10 \dots 100\% I_{1 \text{ nom}}$		2	ms	
$t_{\text{AC } V_1}$	Start-up Time from AC	Time from $V_i$ in range to $V_1$ in regulation		3	sec	
$t_{V_1 \text{ rise}}$	Rise Time	$V_1 = 10 \dots 90\% V_{1 \text{ nom}}$		25	ms	

## 5.1. STANDBY OUTPUT

An optional standby output is available, delivering 12 V with up to 5 A, to provide power to system management controls.

The output is always enabled if the input voltage is within operating range, and provides over current, over voltage and over temperature protections. Current share on standby output is provided by passive droop sharing.

General Condition:  $T_A = 0 \dots 45 \text{ }^\circ\text{C}$  unless otherwise noted.

PARAMETER	DESCRIPTION / CONDITION	MIN	NOM	MAX	UNIT
<b>Standby output VSB</b>					
$V_{SB \text{ nom}}$	Nominal Output Voltage	$I_{SB} = 0 \text{ A}, T_{\text{amb}} = 25 \text{ }^\circ\text{C}$		12	VDC
$V_{SB \text{ set}}$	Output Setpoint Accuracy	$I_{SB} = 0 \text{ A}, T_{\text{amb}} = 25 \text{ }^\circ\text{C}$		-2	+2 % $V_{SB \text{ nom}}$
$dV_{SB \text{ tot}}$	Total Regulation	$V_i \text{ min to } V_i \text{ max}, 0 \text{ to } 100\% I_{1 \text{ nom}}, T_A \text{ min to } T_A \text{ max}$		-4	+4 % $V_{SB \text{ nom}}$
$P_{SB \text{ nom}}$	Nominal Output Power			60	W
$I_{SB \text{ nom}}$	Nominal Output Current			5	ADC
$I_{SB \text{ Lim}}$	Current Limitation			5.5	ADC
$V_{SB \text{ pp}}$	Output Ripple Voltage	20 MHz BW		300	mVpp
$dV_{SB \text{ Load}}$	Load Regulation	0 - 100 % $I_{SB \text{ nom}}$		-70	mV/A
$dV_{SB \text{ Line}}$	Line Regulation	$V_i = V_{i \text{ AC/DC min}} \dots V_{i \text{ AC/DC max}}$		0	mV
$dI_{\text{share}}$	Current Sharing	Deviation from $I_{SB \text{ tot}} / N$		2	ADC
$dV_{\text{dyn}}$	Dynamic Load Regulation	$\Delta I_{SB} = 50\% I_{SB \text{ nom}}, I_{SB} = 10 \dots 100\% I_{SB \text{ nom}}, dI_{SB}/dt = 0.1 \text{ A}/\mu\text{s}, f = 2 \dots 50 \text{ Hz}, \text{Duty cycle} = 20 \dots 80\%$		-600	600 mV
$T_{\text{rec}}$	Recovery Time	Within 1% of $V_{SB}$ final steady state		2	ms
$t_{\text{AC VSB}}$	Start-up Time from AC	Time from $V_i$ in range to $V_{SB}$ in regulation		2	sec
$t_{V_{SB} \text{ rise}}$	Rise Time	$V_{SB} = 10 \dots 90\% V_{SB \text{ nom}}$		20	ms
$V_{\text{uvlo}}$	Under voltage Lockout Level	11.1	11.2	11.3	V

## 5.2. OUTPUT VOLTAGE RIPPLE

The internal output capacitance at the power supply output (behind OR-ing element) is minimized to prevent disturbances during hot plug. To provide low ripple voltage at the application, external capacitors should be added at the input of the connected load circuits.

## 5.3. OVERSUBSCRIPTION

The main output has the capability to allow a load current of up to 10A above the nominal output current rating for a maximum duration of 5 ms. This allows the system to consume extended power for short time dynamic processes. Oversubscription can be used with maximum 10% duty cycle. If the output current is less than 10A above nominal output current, then the oversubscription time can be longer.

## 5.4. OUTPUT ISOLATION

Main and standby output (if available) and all signals are isolated from the chassis and protective earth connection, although the applied voltage must not exceed 100 V<sub>peak</sub> to prevent any damage to the power supply.

The main output return path serves as main power return and reference for the two address signals ADDR0 and ADDR1. Care needs to be taken to reference these address signals as close as possible to the PSU's GND pins.

The CAN bus lines CAN\_H and CAN\_L, the output signal DIGOUT and the input signal PSKILL are referenced to signal ground SGND. These signals and SGND are isolated from main output and chassis allowing a maximum voltage of 50 V<sub>peak</sub> between signals/SGND and main return GND. Signal ground SGND may be connected to power ground GND within the application, shown as dotted lines in *Figure 3*, allowing powering of system communication and logic from VSB output.

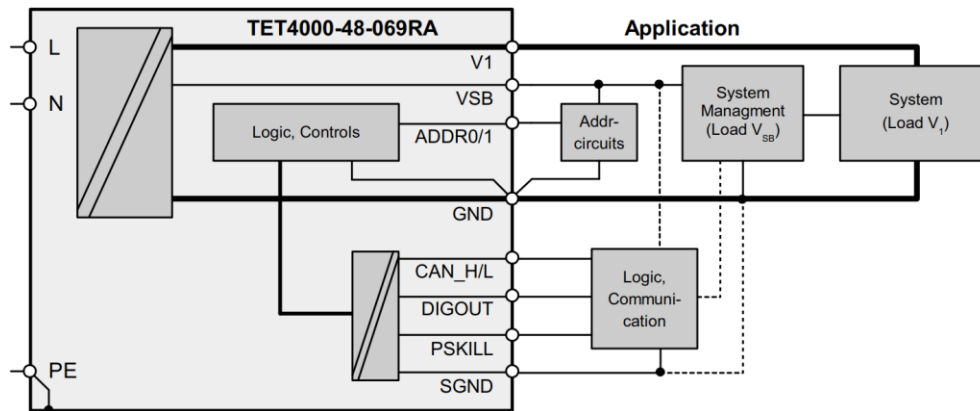

Figure 3. Common Low Impedance Ground Plane

## 6. PROTECTION

PARAMETER	DESCRIPTION / CONDITION	MIN	NOM	MAX	UNIT	
F	Input Fuses (L+N)	Not user accessible, fast-acting (F)		30	A	
V <sub>1</sub> ov	OV Threshold V <sub>1</sub>	64	67	70	VDC	
t <sub>V1</sub> ov	OV Latch Off Time V <sub>1</sub>			1	ms	
P <sub>1</sub> lim	Nominal Power Limitation	V <sub>I AC/DC HL</sub> , T <sub>a</sub> ≤ 45°C, V <sub>1</sub> ≥ 48 VDC		4000	4100	W
I <sub>1</sub> lim	Nominal Current Limitation	V <sub>I AC/DC HL</sub> , T <sub>a</sub> ≤ 45°C		73	76	A
t <sub>1</sub> lim	Power limit blanking time	Time until power limit is reduced to nominal value		5		ms
P <sub>1</sub> os lim	Power limit during oversubscription V <sub>1</sub>	Maximum duration 5 ms		4400	4500	W
I <sub>1</sub> os lim	Current limit during oversubscription V <sub>1</sub>	Maximum duration 5 ms		83	86	A
I <sub>1</sub> sc	Max Short Circuit Current V <sub>1</sub>	V <sub>1</sub> < 10 VDC, excluding output capacitor discharging current			83	ADC
t <sub>1</sub> sc off	Short circuit latch off time	Time to latch off when in short circuit or output under voltage (V <sub>1</sub> < V <sub>1</sub> uv)		20		ms
V <sub>1</sub> uv	Output under voltage protection	42.5	43	43.5	VDC	
t <sub>1</sub> uv	Output under voltage protection delay time	V <sub>1</sub> < V <sub>1</sub> uv		20		ms
T <sub>SD</sub>	Over temperature on critical points	Inlet Ambient Temperature PFC Primary Heatsink Temperature Secondary Sync Mosfet Temperature Secondary OR-ing Mosfet Temperature		TDB		°C
V <sub>SB</sub> uv	Output under voltage protection standby	11.1	11.2	11.3	VDC	
I <sub>SB</sub> Lim	Standby over current limit	5.0	5.5		ADC	

### 6.1. LATCH OFF

For all fault conditions except over current on standby output, the output will shut down and latch off. The latch can be cleared by recycling the input voltage or the PSKILL input. A failure on the main output will only shut down the main output, while the optional standby output continues to operate. A failure on the standby output will only shut down the standby output.

## 6.2. OVER VOLTAGE PROTECTION

The TET front-ends provide a variable threshold, tracking programmed output voltage set-point, implemented in FW plus a fixed threshold over voltage (OV) protection implemented with a HW comparator. Once an OV condition has been triggered, the supply will shut down and latch off as described under 6.1.

## 6.3. UNDER VOLTAGE DETECTION

Both main and optional standby outputs are monitored. LED and PWOK\_L pin signal if the output voltage exceeds  $\pm 7\%$  of its nominal voltage.

Output under voltage protection is provided on both outputs. When the main output falls below  $V_{1UV}$  or the standby output falls below  $V_{SBUV}$ , the output is inhibited and latches off as described under 6.1.

## 6.4. CURRENT LIMITATION MAIN OUTPUT

Two different over current protection features are implemented on the main output.

If the output current exceeds  $I_{1lim}$  for more than 5 ms the output will reduce its voltage, to reduce output current to  $I_{1lim}$ . In case the output voltage will be reduced below the under-voltage level  $V_{1UV}$  the output will turn off after 20 ms, signaling an under-voltage fault.

The 2<sup>nd</sup> protection is a substantially rectangular output characteristic controlled by a software feedback loop. This protects the power supply and system during the 5ms blanking time of the oversubscription mode. If the output current is rising fast and reaches  $I_{1oslim}$ , the supply will immediately reduce its output voltage to prevent the output current from exceeding  $I_{1oslim}$ . When the output current is reduced below  $I_{1oslim}$ , the output voltage will return to its nominal value.

The main output current limitation level  $I_{1lim}$  and  $I_{1oslim}$  are decreased if the ambient (inlet) temperature increases beyond 45°C. The current limit depends on programmed output voltage, to keep output power constant at about 4000 W. See also *Figure 4* for output characteristic and current limitation at different output voltage settings.

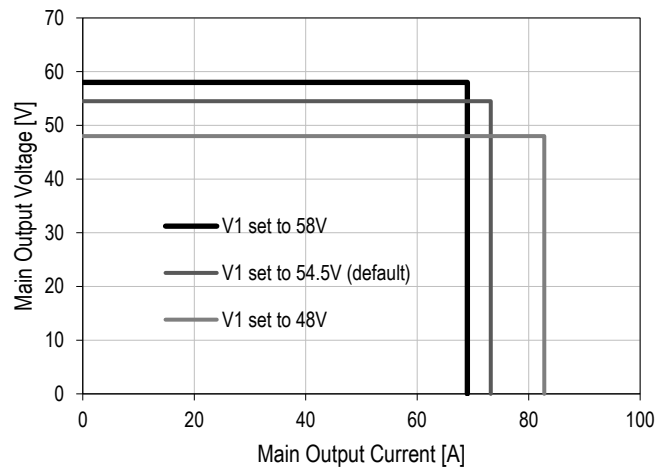

Figure 4. Output characteristics  $V_1$

## 6.5. CURRENT LIMITATION STANDBY OUTPUT

The standby output has a hiccup current limitation implemented. If the standby current exceeds  $I_{SBLim}$  the standby converter switches off and retries automatically after 1 second off time.



## 7. MONITORING

The power supply provides information about operating conditions through its CAN bus interface. Details can be found in the CAN Communication Manual BCA.00231.0. Accuracy of sensors within PSU is given in following table.

PARAMETER	DESCRIPTION / CONDITION	MIN	NOM	MAX	UNIT	
$V_{i\ mon}$	Input RMS Voltage	$V_{i\ min} \leq V_i \leq V_{i\ max}$		-2	+2	%
$I_{i\ mon}$	Input RMS Current	$I_i > 5 A_{rms}$		-5	+5	%
		$I_i \leq 5 A_{rms}$		-0.25	+0.25	$A_{rms}$
$P_{i\ mon}$	True Input Power	$P_i > 800 W$		-5	+5	%
		$P_i \leq 800 W$		-40	+40	W
$V_1\ mon$	$V_1$ Voltage	$V_1 > 40 VDC$		-1	+1	%
$I_1\ mon$	$V_1$ Current	$I_1 > 25 A$		-2	+2	%
		$I_1 \leq 25 A$		-0.5	+0.5	A
$V_{SB\ mon}$	$V_{SB}$ Voltage	$I_{SB} = 0 \dots 5A$		-0.2	+0.2	V
$I_{SB\ mon}$	$V_{SB}$ Current	$I_{SB} = 0 \dots 5A$		-0.5	+0.5	A
$P_1\ mon$	Total Output Power	$P_1 > 1000 W$		-3	+3	%
		$P_1 \leq 1000 W$		-30	+30	W
$T_a\ mon$	Inlet air temperature	$T_a = 0 \dots 45^\circ C$		-2	+2	$^\circ C$

## 8. SIGNALING AND CONTROL

### 8.1. ELECTRICAL CHARACTERISTICS

PARAMETER	DESCRIPTION / CONDITION	MIN	NOM	MAX	UNIT
<b>PSKILL</b>					
$V_{iL}$	Input low level voltage (Main output enabled)	-0.2		0.8	V
$V_{iH}$	Input high level voltage (Main output disabled)	2.0		3.5	V
$I_{iL, H}$	Maximum input sink or source current	0		1	mA
$R_{puPSKILL}$	Internal pull up resistor on PSKILL to internal 3.3V		4.75		k $\Omega$
<b>DIGITAL OUTPUT</b>					
$V_{OL}$	Output low level voltage	$I_{sink} < 4 mA$	-0.2	0.4	V
$V_{puPWOK\_L}$	External pull up voltage	0		13	V
$R_{puPWOK\_L}$	Recommended external pull up resistor on PWOK_L at $V_{puPWOK\_L} = 3.3 V$		10		k $\Omega$
Low level output	Configurable, details to be defined				
High level output	Configurable, details to be defined				

### 8.2. PSKILL INPUT

The PSKILL input is an active-high and trailing pin in the connector and is used to disconnect the main output as soon as the power supply is being plugged out.

This can be connected to SGND, enabling main output as soon as power supply is plugged-in into system with input voltage present. Alternatively, this input can be driven by a logical signal (preferably an open collector signal) from the application, allowing remote control of the main output.

The standby output will remain on regardless of the PSKILL input state. This pin is isolated and referred to SGND. A 4.75 kOhm pullup resistor to 3.3 V is present within the power supply.

### 8.3. DIGITAL OUTPUT

The digital output is an isolated open collector output referred to SGND; its functionality can be configured through CAN bus. Details of functionality to be defined.

### 8.4. CAN BUS INTERFACE

The CAN bus interface serves for information exchange between paralleled power supplies (e.g. for current share) and for communication with a system controller (e.g. voltage setting, monitoring). The CAN bus operates at 1000 kbit/s with a Bel defined protocol. System wiring requires only interconnection of CAN\_H and CAN\_L lines, in addition a 120 Ohm termination resistor is required at each end of the CAN bus to prevent signal reflections.

**NOTE:** To enable active current share between paralleled power supplies, their CAN bus interface must be interconnected.

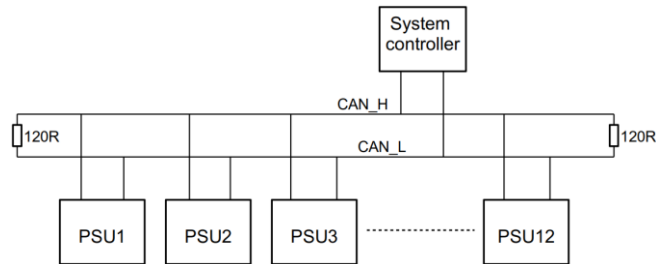

Figure 5. CAN bus wiring

### 8.5. CAN ADDRESSING

The CAN address (Node-ID) of each PSU is a combination of Shelf Number and PSU position within the shelf.

The Shelf-Number is given by a precision voltage source to be applied to the ADDR1 pin (versus power GND). The output impedance of this voltage source should not exceed 100 Ohm and the voltage range is between 0.0 V and 3.0 V. Accuracy is required to be ±30 mV or better.

A resistor needs to be connected from the ADDR0 pin to power GND to define the position of the PSU slot within the shelf. The resistor tolerance needs to be ±1% or lower.

The resulting Node-ID is given by following formula: Node-ID = (Shelf-Nr – 1) \* 16 + Slot-Nr.

If the PSU is not running, the ADDR0 pin is pulled low and the ADDR1 pin is switched to a high impedance input. Thus, the ADDR1 signal may be shared between PSUs while ADDR0 needs to be separated. Refer to the CAN manual for further information.

If either ADDR0 or ADDR1 pins are left open or shorted to GND or 3.0 V the PSU will detect an invalid Node-Id (reflected by corresponding LED state) and will not respond to a CAN request.

Shelf-Nr	Voltage on ADDR1 [V]	Slot-Nr	Resistor on ADDR0 [Ohm]	Resulting Voltage on ADDR0 [V]
1	0.332	1	150	0.130
2	0.664	2	470	0.374
3	0.998	3	866	0.624
4	1.330	4	1330	0.862
5	1.666	5	1960	1.118
6	1.998	6	2740	1.361
7	2.332	7	3900	1.625
8	2.664	8	5620	1.890
		9	8060	2.129
		10	12700	2.381
		11	22600	2.618
		12	75000	2.874

Table 1. Address pin voltage and resistor requirements

## 8.6. FRONT LEDs

The front-end has 2 front LEDs showing the status of the supply. LED number one is green and indicates AC power is on or off, while LED number two is bi-colored: green and yellow, and indicates DC power presence or fault situations. If the PSU is bootloaded both LEDs are alternating green blinking. All other conditions are specified in the *Table 2*. The order of the criteria in the table corresponds to the testing precedence in the controller. LEDs are only available if sufficient input voltage is applied for operation of the internal supply circuits.

OPERATING CONDITION	LED SIGNALING
<b>AC LED</b>	
AC Line within range	Solid Green
AC Line out of range	Off
<b>DC LED</b>	
$V_1$ or $V_{SB}$ out of regulation	
Over temperature shutdown	
Output over voltage shutdown ( $V_1$ or $V_{SB}$ )	Solid Yellow
Output under voltage shutdown ( $V_1$ or $V_{SB}$ )	
Output over current shutdown ( $V_1$ or $V_{SB}$ )	
Invalid Node-Id	Blinking Yellow
Power Supply Turned Off	Blinking Green
Normal Operation	Solid Green
PSU backsupplied	Blinking Yellow
Otherwise	All LEDs off

Table 2. LED Status

## 8.7. CURRENT SHARE

The front-end has an active current share scheme implemented for V1. CAN bus interface of the paralleled power supplies need to be interconnected to activate the sharing function.

The controller implements a Master/Slave current share function. The power supply providing the largest current among the group is automatically the Master. The other supplies will operate as Slaves and increase their output current to a value close to the Master by slightly increasing their output voltage. The voltage increase is limited to +1 V.

The standby output uses a passive current share method (droop output voltage characteristic).

Due to non-ideal current share the maximum total output power of paralleled power supplies is less than the theoretical maximum, and is defined in *Table 3*.

No of paralleled PSUs	Maximum available power on main 48 V		Maximum available power on standby output (optional)	
	without redundancy	n+1 redundancy	without redundancy	n+1 redundancy
1	4000 W	-	60 W	-
2	7800 W	4000 W	95 W	60 W
3	11600 W	7800 W	131 W	95 W
4	15400 W	11600 W	166 W	131 W
5	19200 W	15400 W	202 W	166 W
6	23000 W	19200 W	238 W	202 W

Table 3. Power available when PSU in redundant operation

## 9. TEMPERATURE AND FAN CONTROL

To achieve best cooling results sufficient airflow through the supply must be ensured. Do not block or obstruct the airflow at the rear of the supply by placing large objects directly at the output connector. The TET4000-48-069RA is provided with a reverse airflow, which means the air enters through the front of the supply and leaves at the rear. TET supplies have been designed for horizontal operation.

### 9.1. FAN CONTROL

The average speed of the two individual fans within the dual-axis-fan is controlled to meet the reference. The reference is given by the maximum of following 3 items:

- Load depending Fan Speed curve, see *Figure 6*. This curve is in use at nominal conditions.
- Component depending Fan Speed curve according to *Figure 7*.
- System commanded Fan Speed through CAN bus.

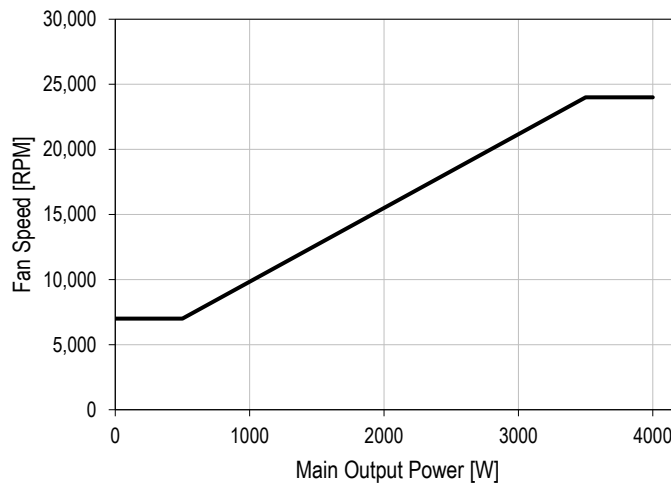

Figure 6. Fan speed versus main output power

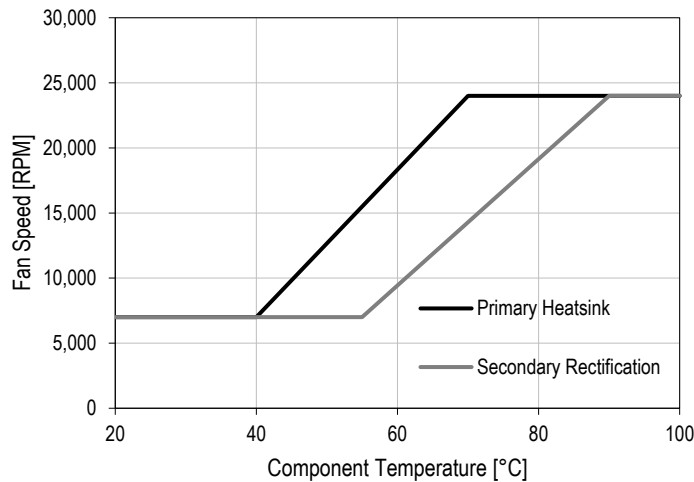

Figure 7. Fan speed versus power stage temperatures

## 10. ELECTROMAGNETIC COMPATIBILITY

### 10.1. IMMUNITY

**NOTE:** Most of the immunity requirements are derived from EN 55024:1998/A2:2003.

PARAMETER	DESCRIPTION / CONDITION	CRITERION
ESD Contact Discharge	IEC / EN 61000-4-2, $\pm 8$ kV, 25+25 discharges per test point (metallic case, LEDs, connector body)	A
ESD Air Discharge	IEC / EN 61000-4-2, $\pm 15$ kV, 25+25 discharges per test point (non-metallic user accessible surfaces)	A
Radiated Electromagnetic Field	IEC / EN 61000-4-3, 10 V/m, 1 kHz/80% Amplitude Modulation, 1 $\mu$ s Pulse Modulation, 10 kHz...2 GHz	A
Burst	IEC / EN 61000-4-4, level 3 AC port $\pm 2$ kV, 1 minute	A
Surge	IEC / EN 61000-4-5, level 3 Line to earth: $\pm 2$ kV Line to line: $\pm 1$ kV	A
RF Conducted Immunity	IEC/EN 61000-4-6, Level 3, 10 Vrms, CW, 0.1 ... 80 MHz	A
Voltage Dips and Interruptions	IEC/EN 61000-4-11 1: $V_i$ 230 Volts, 100% Load, Dip 100%, Duration 12 ms 2: $V_i$ 230 Volts, 100% Load, Dip 100%, Duration < 150 ms 3: $V_i$ 230 Volts, 100% Load, Dip 100%, Duration > 150 ms	A V1: B, VSB: A B

### 10.2. EMISSION

PARAMETER	DESCRIPTION / CONDITION	CRITERION
Conducted Emission	EN55022 / CISPR 22: 0.15 ... 30 MHz, QP and AVG	Class A
Radiated Emission	EN55022 / CISPR 22: 30 MHz ... 1 GHz, QP	Class A
Harmonic Emissions	IEC61000-3-2, $V_{in} = 230$ VAC, 50 Hz, 100% Load	Class A
Audible Noise LpA	$V_{nom}$ , 50% $I_{nom}$ , $T_A = 25^\circ\text{C}$ , at the bystander position	60 dBA
AC Flicker	IEC / EN 61000-3-3, $d_{max} < 3.3\%$	PASS

## 11. SAFETY / APPROVALS

Maximum electric strength testing is performed in the factory according to IEC/EN 60950, and UL 60950. Input-to-output electric strength tests should not be repeated in the field. Bel Power Solutions will not honor any warranty claims resulting from electric strength field tests.

PARAMETER	DESCRIPTION / CONDITION	MIN	NOM	MAX	UNIT
Agency Approvals	Approved to the latest edition of the following standards: UL/CSA 60950-1, IEC60950-1 and EN60950-1				
Isolation Strength	Input (L/N) to case (PE) Input (L/N) to output Output to case (PE)		Basic Reinforced Functional		
$d_c$ Creepage / Clearance	Primary (L/N) to protective earth (PE) Primary to secondary				
Electrical Strength Test	Input to case Input to output (tested by manufacturer only)	2121 4242			VDC

## 12. ENVIRONMENTAL

PARAMETER	DESCRIPTION / CONDITION	MIN	NOM	MAX	UNIT
$T_A$ Ambient Temperature	$V_{i min}$ to $V_{i max}$ , $I_{nom}$ , $I_{SB nom}$ at 4000 m $V_{i min}$ to $V_{i max}$ , $I_{nom}$ , $I_{SB nom}$ at 1800 m	0 0		+35 +45	$^\circ\text{C}$ $^\circ\text{C}$
$T_{Aext}$ Extended Temp. Range	Derated output	+45		+55	$^\circ\text{C}$
$T_S$ Storage Temperature	Non-operational	-40		+70	$^\circ\text{C}$
Altitude	Operational, above Sea Level (see derating)	-		4000	m
Cooling	System Back Pressure			0.5	in-H <sub>2</sub> O



a bel group

Asia-Pacific  
+86 755 298 85888

Europe, Middle East  
+353 61 225 977

North America  
+1 408 785 5200

13. MECHANICAL

PARAMETER	DESCRIPTION / CONDITION	MIN	NOM	MAX	UNIT
Dimensions	Width		69		mm
	Height		40.5		mm
	Depth		530		mm
<i>m</i> Weight			2.7		kg

NOTE: A 3D step file of the power supply casing is available on request.

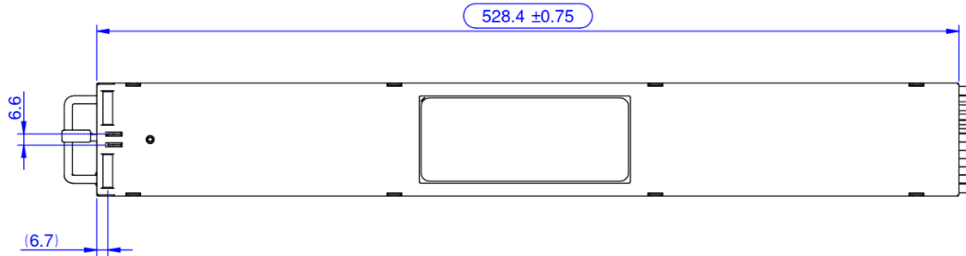

Figure 8. Top view

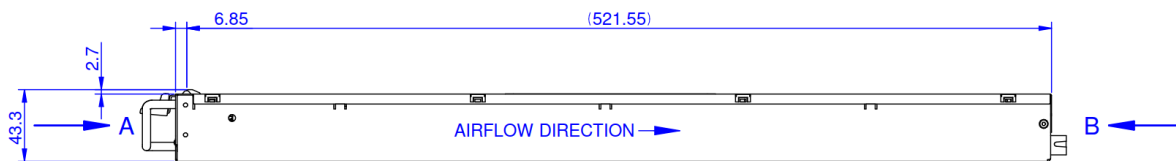

Figure 9. Side view

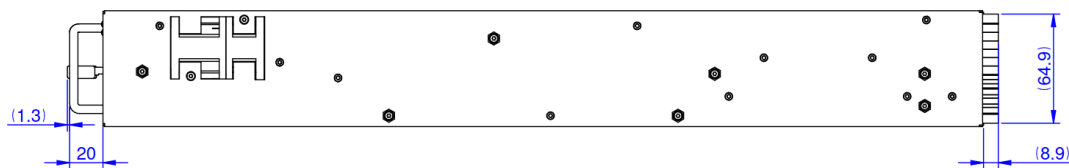

Figure 10. Bottom view

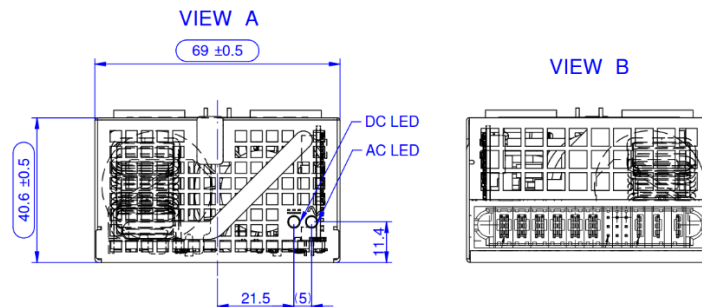

Figure 11. Front and Rear view

### 14. CONNECTOR

Rear side PSU connector serves as interface for input power (AC or HV DC), output power and signals. In order to guarantee proper mating sequence, the below noted connector P/N is required to be used.

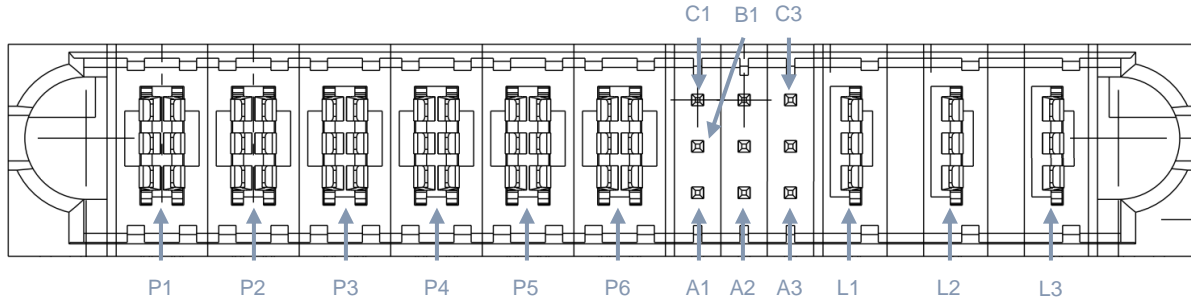

Figure 12. PSU rear side connector, view from mating side

VERSION	TYPE	MANUFACTURER	BEL P/N	MANUFACTURER P/N
PSU Connector	PWRBLADE ULTRA®	Amphenol FCI	-	10127397-07H1420LF
System Connector	PWRBLADE ULTRA®	Amphenol FCI	ZES.01164 ZES.01224	10127401-08H1420LF (Solder version) 10127400-01H1420LF (Press-Fit version)

PIN	SIGNAL NAME	DESCRIPTION	MATING SEQUENCE
L1	PE	Protective Earth	1
L2	N	AC or HV DC input line (Neutral)	2
L3	L	AC or HV DC input line (Line)	2
P1, P2, P3	GND	Power and ADDR0, ADDR1 return	1
P4, P5, P6	V1	+54.5 V main output	2
A1	PSKILL	Power supply kill (latching pin); active-high	3
B1	DIGOUT	Configurable digital open collector output	2
C1	SGND	Isolated GND. CAN, PSKILL and DIGOUT are referred to it.	2
A2	ADDR0	Analog input for PSU address setting	2
B2	CAN_H	CAN-Interface, High <sup>3</sup>	2
C2	CAN_L	CAN-Interface, Low <sup>4</sup>	2
A3	ADDR1	Analog input for Shelf address setting <sup>5</sup>	2
B3, C3	VSB	+12 V Standby output	2



Table 4. Pin assignment

<sup>3</sup> With future I2C implementation will be optionally SDA

<sup>4</sup> With future I2C implementation will be optionally SCL

<sup>5</sup> With future I2C implementation will be optionally used as digital bidirectional share bus

## 15. ACCESSORIES

ITEM	DESCRIPTION	ORDERING PN	SOURCE
	<b>Interface Utility</b> Windows compatible GUI to program, control and monitor Bel products	N/A	<a href="http://belfuse.com/power-solutions">belfuse.com/power-solutions</a>
	<b>Evaluation Board</b> Evaluation board to operate 2Pcs TET4000-48-069RA	YTM.U1900.0	Bel Power Solutions

## 16. REVISION HISTORY

REV	DESCRIPTION	PSU PRODUCT VERSION	DATE	AUTHOR
001	Initial Draft.	V001	04-Jan-2017	WU
002	13. Corrected PSU height			
003	Adjust Specifications to align with PSU electrical design	V002	2017-10-23	RB
004	Formatting Changes	V003	2017-11-07	VS
005	Add CAN address section 8.5, add fan control 9.1, add mechanical outline and weight 13, add optional I2C interface 14, add P/N for mating connector 14, add adapter board P/N 15	V003	2018-01-16	RB/WU

For more information on these products consult: [tech.support@psbel.com](mailto:tech.support@psbel.com)

**NUCLEAR AND MEDICAL APPLICATIONS** - Products are not designed or intended for use as critical components in life support systems, equipment used in hazardous environments, or nuclear control systems.

**TECHNICAL REVISIONS** - The appearance of products, including safety agency certifications pictured on labels, may change depending on the date manufactured. Specifications are subject to change without notice.