

- HVDC 400A at 450VDC.
- Max. Switching current = 2000A.
- AgSnO₂ contacts sealed in inert gas.
- Magnet arc blowout.
- Auxiliary contact option.
- Female M6 or M8 Male power terminals.



Ordering Code

DEVR40 - 50 61 - S8 - 0936 - R 1

Series

Contact Material

50: AgSnO₂

Contact Arrangement

61: SPST-NO*

71: SPST-NO* + Auxiliary

81: SPST-NO

91: SPST-NO + Auxiliary

* Polarized - see page 2

Mounting & Connections

Bottom flange mounting base

S8: M8 Male stud power terminals

S9: M6 Female thread power terminals

Coil & auxiliary contacts by flying leads

Coil Code

See coil codes - Table 1

Coil Wire Length

R: 14.96" (380mm)

T: 5.9" (150mm)

Coil Wire & Auxiliary Contact Termination

1: None

2: Yazaki 7282-5558-10 Male

3: Molex Mini-Fit Female

Other terminations to special order

Contacts

Contact arrangement		SPST-NO-DM
Contact material		AgSnO ₂
Max switching voltage	AC/DC	900VDC
Rated load (resistive, cos φ=1)	DC1	400A 450VDC
Max continuous thermal current	550 secs	600A
	90secs	1000A
Max. switching current	1 time only	2000A 350VDC
Initial contact resistance	max.	1mΩ (at 1A)
Auxiliary Contact (when fitted)	Arrangement	SPST-NO (1 Form A) (SPST-NC by request)
	Max. Current	2A @ 30VDC / 3A @ 125VAC
	Min. Current	100mA @ 8V

Coil

Rated Voltage (see page 2)	DC	9~36Vdc, 32-95Vdc (with coil economizer)
Rated power consumption	hold	1.56W @ 12VDC

Insulation

Insulation resistance	Initial	100MΩ (Min.)
	Life End	50MΩ (Min.)
Dielectric strength	coil to contact	2500Vrms / 1mA / 1 min (at sea level)
	contact to contact	2500Vrms / 1mA / 1 min (at sea level)

General Data

Operate time at 20°C	max.	25ms
Bounce time	max.	7ms
Release time	max.	12ms
Electrical life		Voltage and Current Dependent - See Fig. 1
Mechanical life	ops.	2 x 10 ⁵
Ambient temperature	operating	-40 to +85°C
Relative humidity		5 to 85%RH
Shock resistance		20G peak, 11ms 1/2 sine
Vibration resistance		20G sine peak (80 to 2000Hz)
Dimensions	L x W x H	58.2 x 80.48 (over flanges) x 72.11 (max.)
Weight	approx.	430g ±10g

DEVR40 series

HVDC contactor 400A / 900VDC



Coil Data

Table 1

Coil code	Nominal voltage (VDC)	Must operate voltage Max. (VDC)	Maximum allowable voltage (VDC)	Must release voltage min. (VDC)	Inrush Current Max. (A)	Hold Voltage Min. (VDC)	Holding Current (Average)
0936	9 - 36	9	36	6	3.8	7.5	130mA@12VDC 70mA @ 24VDC
3295	32 - 95	32	95	18	1.3	22	30mA@48VDC

Other coils available upon special request.

Electrical Performance

Fig 1.

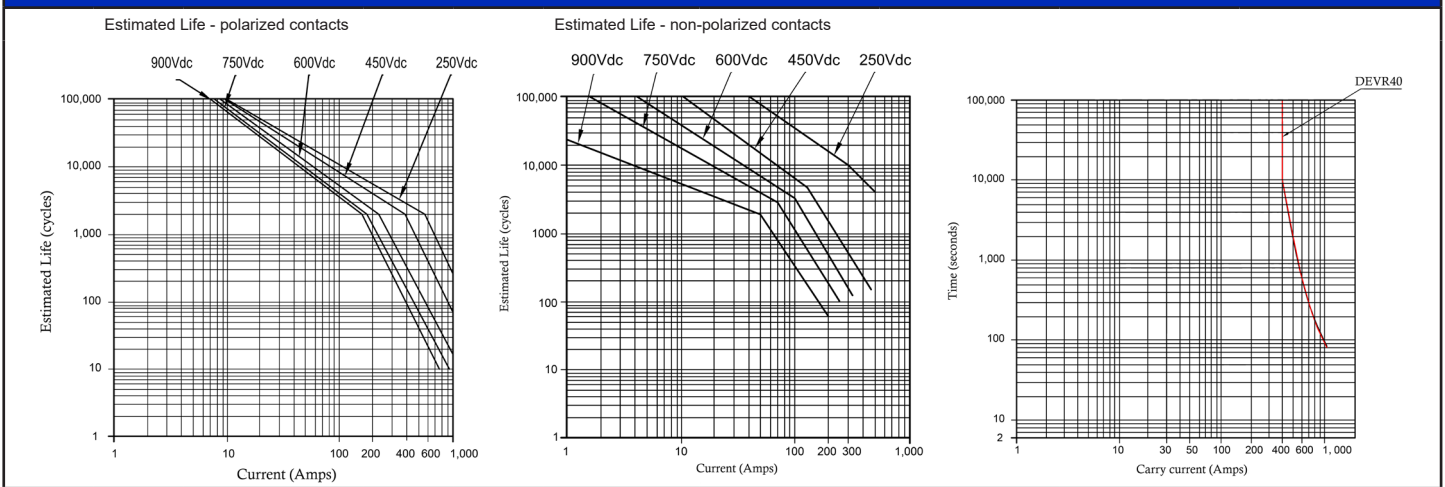

Dimensions (mm)

Fig 2.

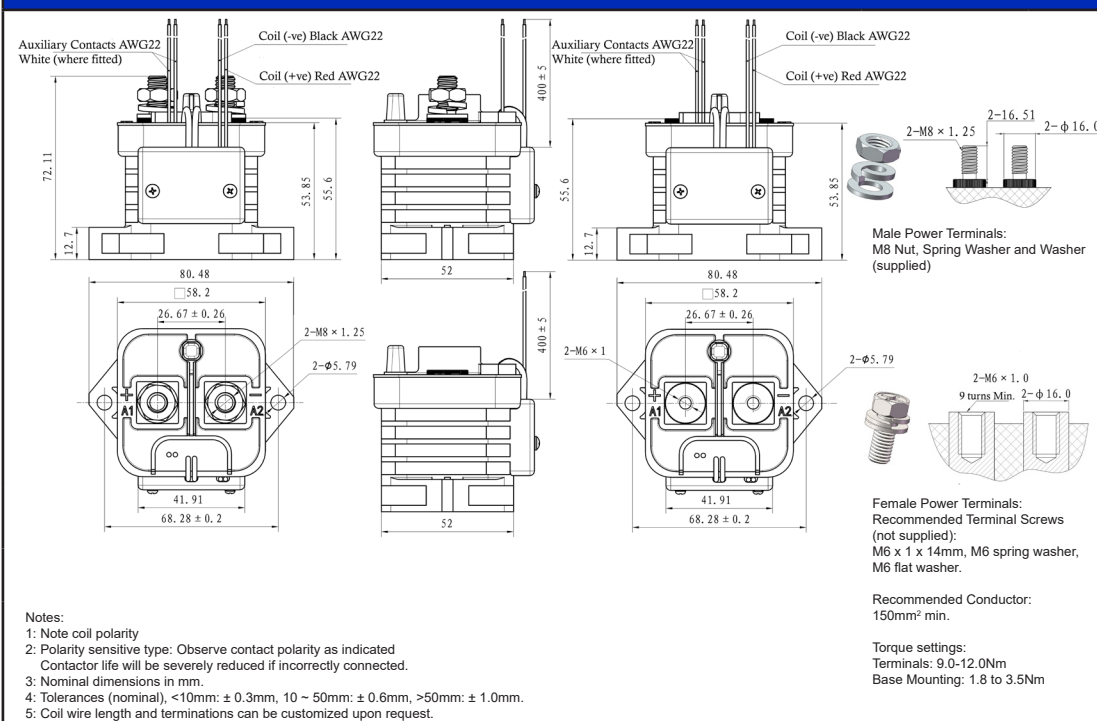

Circuit Diagrams

Fig 3.

