

ALA7D, Aluminum Electrolytic, 85C, 510 uF, 20%, 400 VDC, -40/+85C

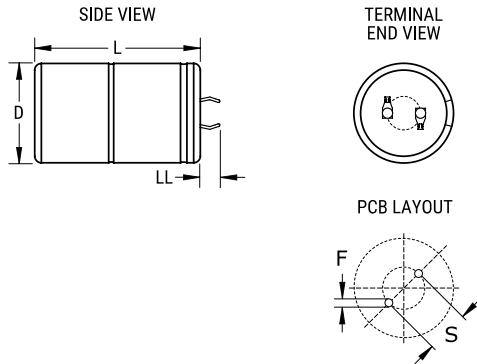

Dimensions	
D	30mm +1mm
L	45mm +/-2mm
S	10mm +/-0.1mm
LL	6.3mm +/-1mm
F	2mm +/-0.1mm

Packaging Specifications	
Weight:	55 g
Packaging:	Bulk, Bag
Packaging Quantity:	160

General Information	
Supplier:	KEMET
Series:	ALA7D
Dielectric:	Aluminum Electrolytic
Description:	Snap-In, Aluminum Electrolytic
RoHS:	Yes
Lead:	2 Pin
Qualifications:	AEC-Q200
AEC-Q200:	Yes
Miscellaneous:	Vibration: <= 35mm 1.5mm displacement amplitude or 20G maximum acceleration. Vibration applied for three directions of 4-hour sessions at 10 – 2,000 Hz. (Capacitor clamped by body.)
Shelf Life:	156 Weeks

Specifications	
Capacitance:	510 uF
Capacitance Tolerance:	20%
Voltage DC:	400 VDC, 440 VDC (Surge)
Temperature Range:	-40/+85C
Rated Temperature:	85C
Life:	13000 Hrs (Rated Voltage And Ripple Current At 85C), 21000 Hrs (Rated Voltage At 85C)
Resistance:	345.2 mOhms (100Hz 20C), 211.6 mOhms (10kHz 20C)
Ripple Current:	2.19 Amps (100Hz 105C), 4.76 Amps (10kHz 105C)
Leakage Current:	1224 uA (5min 20C)