

ALA7D, Aluminum Electrolytic, 85C, 510 uF, 20%, 500 VDC, -40/+85C

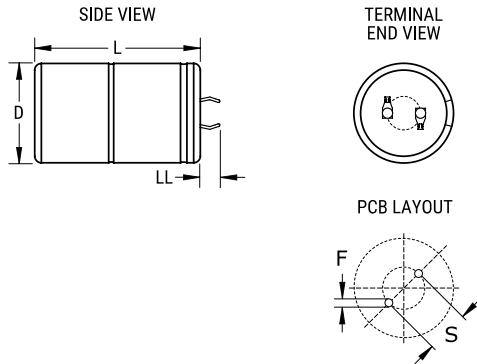

| Dimensions | |
|------------|---------------|
| D | 35mm +1mm |
| L | 50mm +/-2mm |
| S | 10mm +/-0.1mm |
| LL | 6.3mm +/-1mm |
| F | 2mm +/-0.1mm |

| Packaging Specifications | |
|--------------------------|-----------|
| Weight: | 80 g |
| Packaging: | Bulk, Bag |
| Packaging Quantity: | 100 |

| General Information | |
|---------------------|---|
| Supplier: | KEMET |
| Series: | ALA7D |
| Dielectric: | Aluminum Electrolytic |
| Description: | Snap-In, Aluminum Electrolytic |
| RoHS: | Yes |
| Lead: | 2 Pin |
| Qualifications: | AEC-Q200 |
| AEC-Q200: | Yes |
| Miscellaneous: | Vibration: <= 35mm 1.5mm displacement amplitude or 20G maximum acceleration. Vibration applied for three directions of 4-hour sessions at 10 – 2,000 Hz. (Capacitor clamped by body.) |
| Shelf Life: | 156 Weeks |

| Specifications | |
|------------------------|---|
| Capacitance: | 510 uF |
| Capacitance Tolerance: | 20% |
| Voltage DC: | 500 VDC, 550 VDC (Surge) |
| Temperature Range: | -40/+85C |
| Rated Temperature: | 85C |
| Life: | 15000 Hrs (Rated Voltage And Ripple Current At 85C), 24000 Hrs (Rated Voltage At 85C) |
| Resistance: | 489.8 mOhms (100Hz 20C), 371.2 mOhms (10kHz 20C) |
| Ripple Current: | 2.55 Amps (100Hz 105C), 4.81 Amps (10kHz 105C) |
| Leakage Current: | 1530 uA (5min 20C) |

Statements of suitability for certain applications are based on our knowledge of typical operating conditions for such applications, but are not intended to constitute - and we specifically disclaim - any warranty concerning suitability for a specific customer application or use. This Information is intended for use only by customers who have the requisite experience and capability to determine the correct products for their application. Any technical advice inferred from this Information or otherwise provided by us with reference to the use of our products is given gratis, and we assume no obligation or liability for the advice given or results obtained.