

ALA8D, Aluminum Electrolytic, 105C, 360 uF, 20%, 450 VDC, -40/+105C

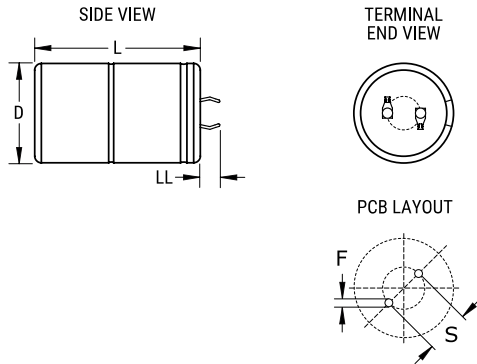

Dimensions	
D	30mm +1mm
L	45mm +/-2mm
S	10mm +/-0.1mm
LL	6.3mm +/-1mm
F	2mm +/-0.1mm

Packaging Specifications	
Weight:	55 g
Packaging:	Bulk, Bag
Packaging Quantity:	160

General Information	
Supplier:	KEMET
Series:	ALA8D
Dielectric:	Aluminum Electrolytic
Description:	Snap-In, Aluminum Electrolytic
RoHS:	Yes
Lead:	2 Pin
Qualifications:	AEC-Q200
AEC-Q200:	Yes
Miscellaneous:	Vibration: <= 35mm 1.5mm displacement amplitude or 20G maximum acceleration. Vibration applied for three directions of 4-hour sessions at 10 – 2,000 Hz. (Capacitor clamped by body.)
Shelf Life:	156 Weeks

Specifications	
Capacitance:	360 uF
Capacitance Tolerance:	20%
Voltage DC:	450 VDC, 495 VDC (Surge)
Temperature Range:	-40/+105C
Rated Temperature:	105C
Life:	7000 Hrs (Rated Voltage And Ripple Current At 105C), 11000 Hrs (Rated Voltage At 105C)
Resistance:	379 mOhms (100Hz 20C), 221.8 mOhms (10kHz 20C)
Ripple Current:	2.15 Amps (100Hz 105C), 5.9 Amps (10kHz 105C)
Leakage Current:	972 uA (5min 20C)