

RSB, Film, Metallized Polyester Stacked, Automotive Grade, 1500 pF, 10%, 630 VDC, 85C, Lead Spacing = 5mm

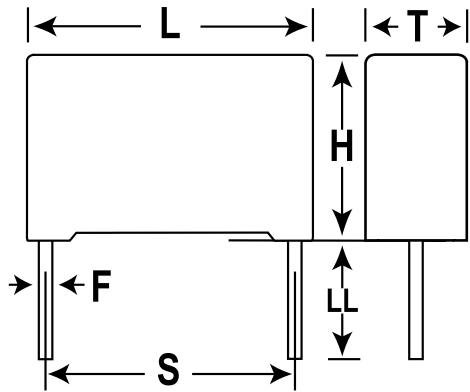

Dimensions	
L	7.2mm +0.2mm
H	7.5mm +0.1mm
T	3.5mm +0.2mm
S	5mm +/-0.4mm
LL	17mm +1/-2mm
F	0.6mm +/-0.05mm

Packaging Specifications	
Packaging:	Bulk, Bag
Packaging Quantity:	3000

General Information	
Supplier:	KEMET
Series:	RSB
Dielectric:	Metallized Polyester Stacked
Style:	Radial
Features:	Automotive Grade, DC Multipurpose Applications
RoHS:	Yes
Lead:	Wire Leads
Qualifications:	AEC-Q200
AEC-Q200:	Yes
Miscellaneous:	Above 85C DC And AC Voltage Derating Is 1.25%/C

Specifications	
Capacitance:	1500 pF
Capacitance Tolerance:	10%
Voltage AC:	220 VAC
Voltage DC:	630 VDC
Temperature Range:	-55/+125C
Rated Temperature:	85C
Dissipation Factor:	0.80% 1kHz, 1.20% 10kHz, 2.50% 100kHz
Insulation Resistance:	30 GOhms
Max dV/dt:	800 V/us
Inductance:	7 nH