

OMNIMATE Signal - series LM LM 3.50/11/90 3.2SN OR BX

Weidmüller Interface GmbH & Co. KG
Klingenbergstraße 16
D-32758 Detmold
Germany
Fon: +49 5231 14-0
Fax: +49 5231 14-292083
www.weidmueller.com

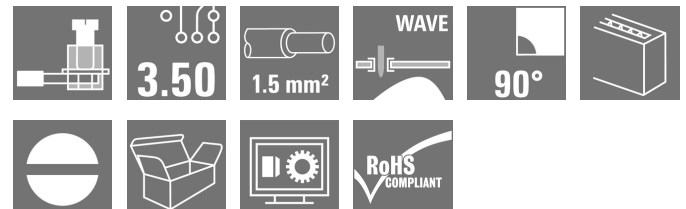

Small, compact PCB terminal or -tier PCB terminal with proven clamping yoke connection and 3.5 mm pitch. Suitable for conductor cross-sections up to 1.5 mm².

- 0.20 - 1.50 mm² (IEC) / 28 - 14 AWG (UL)
- 320 V (IEC) / 300 V (UL)
- 16 A (IEC) / 10 A (UL)

General ordering data

Type	LM 3.50/11/90 3.2SN OR BX
Order No.	1845100000
Version	PCB terminal, 3.50 mm, No. of poles: 11, 90°, Solder pin length (l): 3.2 mm, tinned, Orange, Clamping yoke connection, Clamping range, max.: 2.08 mm ² , Box
GTIN (EAN)	4032248357918
Qty.	50 pc(s).
Product data	IEC: 320 V / 16 A / 0.5 - 1.5 mm ² UL: 300 V / 10 A / AWG 28 - AWG 14
Packaging	Box

OMNIMATE Signal - series LM
LM 3.50/11/90 3.2SN OR BX

Weidmüller Interface GmbH & Co. KG
 Klingenbergstraße 16
 D-32758 Detmold
 Germany
 Fon: +49 5231 14-0
 Fax: +49 5231 14-292083
 www.weidmueller.com

Technical data**Dimensions and weights**

Net weight	6.78 g
------------	--------

System parameters

Product family	OMNIMATE Signal - series LM	Wire connection method	Clamping yoke connection
Mounting onto the PCB	THT solder connection	Conductor outlet direction	90°
Pitch in mm (P)	3.5 mm	Pitch in inches (P)	0.138 inch
No. of poles	11	Fitted by customer	Yes
Max. adjacent poles per row	24	Solder pin length (l)	3.2 mm
Solder pin dimensions	1.0 x 0.6 mm	Solder eyelet hole diameter (D)	1.3 mm
Solder eyelet hole diameter tolerance (D)	+ 0,1 mm	Number of solder pins per pole	1
Screwdriver blade	0.4 x 2.5	Screwdriver blade standard	DIN 5264
Tightening torque, min.	0.2 Nm	Tightening torque, max.	0.25 Nm
Clamping screw	M 2	Stripping length	5 mm
L1 in mm	35 mm	L1 in inches	1.378 inch
Touch-safe protection acc. to DIN VDE 0470	IP 20	Touch-safe protection acc. to DIN VDE 57 106	Safe from finger touch
Volume resistance	3.60 mΩ		

Material data

Insulating material	PA	Colour	Orange
Colour chart (similar)	RAL 2000	Insulating material group	I
CTI	≥ 600	Insulation resistance	≥ 10 ⁸ Ω
UL 94 flammability rating	V-2	Contact material	Copper alloy
Contact surface	tinned	Coating	1-3 μm Ni, 4-6 μm SN
Tinning type	matt	Layer structure of solder connection	1.5-3 μm Ni / 4-6 μm Sn matt
Storage temperature, min.	-25 °C	Storage temperature, max.	55 °C
Max. relative humidity during storage	80 %	Operating temperature, min.	-50 °C
Operating temperature, max.	100 °C	Temperature range, installation, min.	-25 °C
Temperature range, installation, max.	100 °C		

Conductors suitable for connection

Clamping range, min.	0.08 mm ²	Clamping range, max.	2.08 mm ²
Wire connection cross section AWG, min.	AWG 28	Wire connection cross section AWG, max.	AWG 14
Solid, min. H05(07) V-U	0.5 mm ²	Solid, max. H05(07) V-U	1.5 mm ²
Flexible, min. H05(07) V-K	0.5 mm ²	Flexible, max. H05(07) V-K	1.5 mm ²
w. plastic collar ferrule, DIN 46228 pt 4, min.	0.5 mm ²	w. plastic collar ferrule, DIN 46228 pt 4, max.	0.75 mm ²
Plug gauge acc. to EN 60999 a x b; Ø	2.4 mm x 1.5 mm		

OMNIMATE Signal - series LM
LM 3.50/11/90 3.2SN OR BX

Weidmüller Interface GmbH & Co. KG
 Klingenbergstraße 16
 D-32758 Detmold
 Germany
 Fon: +49 5231 14-0
 Fax: +49 5231 14-292083
 www.weidmueller.com

Technical data**Rated data acc. to IEC**

tested acc. to standard	IEC 60664-1, IEC 61984	Rated current, min. no. of poles (Tu=20°C)	16 A
Rated current, max. no. of poles (Tu=20°C)	12 A	Rated current, min. no. of poles (Tu=40°C)	14 A
Rated current, max. no. of poles (Tu=40°C)	10 A	Rated voltage for surge voltage class / pollution degree II/2	320 V
Rated voltage for surge voltage class / pollution degree III/2	160 V	Rated voltage for surge voltage class / pollution degree III/3	160 V
Rated impulse voltage for surge voltage class/ pollution degree II/2	2.5 kV	Rated impulse voltage for surge voltage class/ pollution degree III/2	2.5 kV
Rated impulse voltage for surge voltage class/ contamination degree III/3	2.5 kV	Short-time withstand current resistance	3 x 1s with 72 A

Rated data acc. to CSA

Institute (CSA)		Certificate No. (CSA)	154685-1202192
Rated voltage (Use group B)	300 V	Rated voltage (use group D)	300 V
Rated current (use group B)	10 A	Rated current (use group D)	10 A
Wire cross-section, AWG, min.	AWG 28	Wire cross-section, AWG, max.	AWG 14
Reference to approval values	Specifications are maximum values, details - see approval certificate.		

Rated data acc. to UL 1059

Institute (UR)		Certificate No. (UR)	E60693
Rated voltage (use group B)	300 V	Rated voltage (use group D)	300 V
Rated current (use group B)	10 A	Rated current (use group D)	10 A
Wire cross-section, AWG, min.	AWG 28	Wire cross-section, AWG, max.	AWG 14
Reference to approval values	Specifications are maximum values, details - see approval certificate.		

Classifications

ETIM 3.0	EC001284	ETIM 4.0	EC002643
ETIM 5.0	EC002643	ETIM 6.0	EC002643
UNSPSC	30-21-18-01	eClass 6.2	27-26-11-01
eClass 7.1	27-44-04-01	eClass 8.1	27-44-04-01
eClass 9.0	27-44-04-01	eClass 9.1	27-44-04-01

Data sheet

**OMNIMATE Signal - series LM
LM 3.50/11/90 3.2SN OR BX**

Weidmüller Interface GmbH & Co. KG
Klingenbergstraße 16
D-32758 Detmold
Germany
Fon: +49 5231 14-0
Fax: +49 5231 14-292083
www.weidmueller.com

Technical data

Notes

Notes	<ul style="list-style-type: none"> • Additional colours on request • Rated current related to rated cross-section & min. No. of poles. • Max. outer diameter of the conductor: 2.9 mm • Wire end ferrule with plastic collar to DIN 46228/4 • P on drawing = pitch • Rated data refer only to the component itself. Clearance and creepage distances to other components are to be designed in accordance with the relevant application standards.
IPC conformity	Conformity: The products are developed, manufactured and delivered according international recognized standards and norms and comply with the assured properties in the data sheet resp. fulfill decorative properties in accordance with IPC-A-610 "Class 2". Further claims on the products can be evaluated on request.

Approvals

Approvals



ROHS Conform

Downloads

Approval/Certificate/Document of Conformity	Declaration of the Manufacturer
Brochure/Catalogue	FL DRIVES EN FL ANALO.SIGN.CONV. EN MB DEVICE MANUF. EN FL DRIVES DE CAT 2 PORTFOLIOGUIDE EN FL BUILDING SAFETY EN FL APPL LED LIGHTING EN FLIndustr.CONTROLS EN FL MACHINE SAFETY EN FL HEATING ELECTR EN FL APPL INVERTER EN FL_BASE_STATION EN FL ELEVATOR EN FL POWER SUPPLY EN FL 72H SAMPLE SER EN PO OMNIMATE EN
Engineering Data	EPLAN_WSCAD
Engineering Data	LM.zip STEP

**OMNIMATE Signal - series LM
LM 3.50/11/90 3.2SN OR BX**

Weidmüller Interface GmbH & Co. KG
 Klingenbergstraße 16
 D-32758 Detmold
 Germany
 Fon: +49 5231 14-0
 Fax: +49 5231 14-292083
 www.weidmueller.com

Drawings

Dimensional drawing

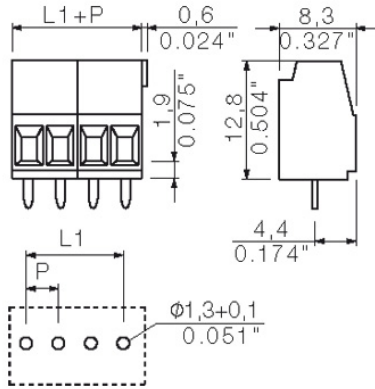

Graph

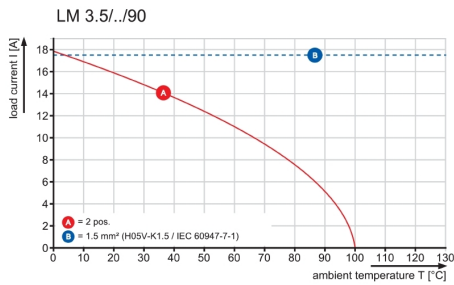

Recommended wave soldering profiles

Weidmüller Interface GmbH & Co. KG
 Klängenbergstraße 16
 D-32758 Detmold
 Germany
 Fon: +49 5231 14-0
 Fax: +49 5231 14-292083
 www.weidmueller.com

Single Wave:



Double Wave:



Wave soldering profiles

Wired connection elements should be processed in accordance with the DIN EN 61760-1 standard. We have included two recommendations for practical wave soldering profiles, with which Weidmüller PCB terminals and connectors are qualified.

When choosing a suitable profile for your application, the following factors also need to be considered:

- PCB thickness
- Proportion of Cu in the layers
- Single/double-sided assembly
- Product range
- Heating and cooling rates

The single and double wave profiles each indicate the recommended operating range, including the maximum soldering temperature of 260°C. In practice, the maximum soldering temperature is quite often well below the above maximum profile.