

## OMNIMATE Signal - series BC/SC 3.81 BCF 3.81/03/180F SN OR BX

**Weidmüller Interface GmbH & Co. KG**  
Klingenbergstraße 16  
D-32758 Detmold  
Germany  
Fon: +49 5231 14-0  
Fax: +49 5231 14-292083  
www.weidmueller.com

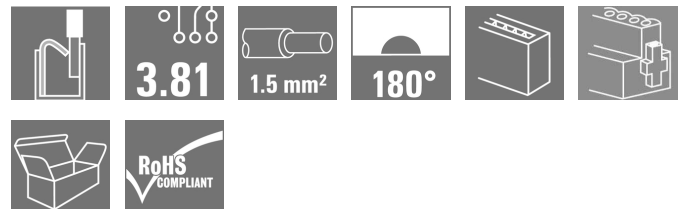

PUSH IN - Weidmüller's innovative connection system simplifies the wire connection process.

The benefits for users and applications:

- High packaging density due to very low component height. Simply insert the prepared wire - finished
- High component density with the compact SCDN / SCDN-THR two-tier pin header
- Simplified processing due to integrated push buttons for opening the clamping unit
- Intuitive handling – since the wire-entry area and handling area are clearly separated
- tool-free locking and releasing when using Weidmüller's patented release latch (LR)

The Weidmüller plug-in connectors, pitch 3.81 mm (0.15 inch), are compatible with the layout of customary plug-in connectors, can be coded and provide space for printing.

### General ordering data

Type	BCF 3.81/03/180F SN OR BX
Order No.	<a href="#">1970330000</a>
Version	PCB plug-in connector, female plug, 3.81 mm, No. of poles: 3, 180°, PUSH IN, Clamping range, max. : 1.5 mm², Box
GTIN (EAN)	4032248679928
Qty.	50 pc(s).
Product data	IEC: 320 V / 17.5 A / 0.14 - 1.5 mm² UL: 300 V / 10 A / AWG 26 - AWG 16
Packaging	Box

**OMNIMATE Signal - series BC/SC 3.81  
BCF 3.81/03/180F SN OR BX**

**Weidmüller Interface GmbH & Co. KG**  
Klingenbergstraße 16  
D-32758 Detmold  
Germany  
Fon: +49 5231 14-0  
Fax: +49 5231 14-292083  
www.weidmueller.com

**Technical data**
**Dimensions and weights**

Net weight 3.5 g

**System parameters**

Product family		Type of connection	
Product family	OMNIMATE Signal - series BC/SC 3.81	Type of connection	Field connection
Wire connection method	PUSH IN	Pitch in mm (P)	3.81 mm
Pitch in inches (P)	0.15 inch	Conductor outlet direction	180°
No. of poles	3	L1 in mm	7.62 mm
L1 in inches	0.3 inch	Number of rows	1
Pin series quantity	1	Rated cross-section	1 mm <sup>2</sup>
Touch-safe protection acc. to DIN VDE 57 106	Safe from finger touch	Touch-safe protection acc. to DIN VDE 0470	IP 20
Volume resistance	6.00 mΩ	Can be coded	Yes
Stripping length	9 mm	Tightening torque for screw flange, min.	0.2 Nm
Tightening torque for screw flange, max.	0.3 Nm	Actuating force actuating element, max.	40 N
Screwdriver blade	0.4 x 2.5	Screwdriver blade standard	DIN 5264
Plugging cycles	25	push-in force/pole	0 N
Packaging	Box		

**Material data**

Insulating material		Colour	
Insulating material	PA GF	Colour	Orange
Colour chart (similar)	RAL 2000	Insulating material group	II
CTI	≥ 550	Insulation resistance	≥ 10 <sup>8</sup> Ω
UL 94 flammability rating	V-0	Layer structure of plug contact	4-8 μm Sn matt
Storage temperature, min.	-25 °C	Storage temperature, max.	55 °C
Max. relative humidity during storage	80 %	Operating temperature, min.	-50 °C
Operating temperature, max.	120 °C	Temperature range, installation, min.	-25 °C
Temperature range, installation, max.	120 °C		

**Conductors suitable for connection**

Clamping range, min.		Clamping range, max.	
Clamping range, min.	0.14 mm <sup>2</sup>	Clamping range, max.	1.5 mm <sup>2</sup>
Wire connection cross section AWG, min.	AWG 26	Wire connection cross section AWG, max.	AWG 16
Solid, min. H05(07) V-U	0.14 mm <sup>2</sup>	Solid, max. H05(07) V-U	1.5 mm <sup>2</sup>
Flexible, min. H05(07) V-K	0.14 mm <sup>2</sup>	Flexible, max. H05(07) V-K	1.5 mm <sup>2</sup>
w. plastic collar ferrule, DIN 46228 pt 4, min.	0.25 mm <sup>2</sup>	w. plastic collar ferrule, DIN 46228 pt 4, max.	1 mm <sup>2</sup>
w. wire end ferrule, DIN 46228 pt 1, min.	0.25 mm <sup>2</sup>	w. wire end ferrule, DIN 46228 pt 1, max.	1.5 mm <sup>2</sup>
Plug gauge acc. to EN 60999 a x b; Ø	2.4 mm x 1.5 mm; 1.9mm		

**OMNIMATE Signal - series BC/SC 3.81  
BCF 3.81/03/180F SN OR BX**

**Weidmüller Interface GmbH & Co. KG**  
Klingenbergstraße 16  
D-32758 Detmold  
Germany  
Fon: +49 5231 14-0  
Fax: +49 5231 14-292083  
www.weidmueller.com

**Technical data**

**Rated data acc. to IEC**

tested acc. to standard	IEC 60664-1, IEC 61984	Rated current, min. no. of poles (Tu=20°C)	17.5 A
Rated current, max. no. of poles (Tu=20°C)	17.5 A	Rated current, min. no. of poles (Tu=40°C)	17.5 A
Rated current, max. no. of poles (Tu=40°C)	16.3 A	Rated voltage for surge voltage class / pollution degree II/2	320 V
Rated voltage for surge voltage class / pollution degree III/2	160 V	Rated voltage for surge voltage class / pollution degree III/3	160 V
Rated impulse voltage for surge voltage class/ pollution degree II/2	2.5 kV	Rated impulse voltage for surge voltage class/ pollution degree III/2	2.5 kV
Rated impulse voltage for surge voltage class/ contamination degree III/3	2.5 kV	Short-time withstand current resistance	3 x 1s with 76 A

**Rated data acc. to CSA**

Institute (CSA)		Certificate No. (CSA)	200039-1121690
Rated voltage (Use group B)	300 V	Rated voltage (Use group C)	50 V
Rated voltage (use group D)	300 V	Rated current (use group B)	11 A
Rated current (use group C)	11 A	Rated current (use group D)	11 A
Wire cross-section, AWG, min.	AWG 26	Wire cross-section, AWG, max.	AWG 16
Reference to approval values	Specifications are maximum values, details - see approval certificate.		

**Rated data acc. to UL 1059**

Institute (cURus)		Certificate No. (cURus)	E60693
Rated voltage (use group B)	300 V	Rated voltage (use group D)	300 V
Rated current (use group B)	10 A	Rated current (use group D)	10 A
Wire cross-section, AWG, min.	AWG 26	Wire cross-section, AWG, max.	AWG 16
Reference to approval values	Specifications are maximum values, details - see approval certificate.		

**Classifications**

ETIM 4.0	EC002637	ETIM 5.0	EC002637
ETIM 6.0	EC002637	UNSPSC	30-21-18-10
eClass 5.1	27-26-07-04	eClass 6.2	27-26-07-04
eClass 7.1	27-44-04-02	eClass 8.1	27-44-04-02
eClass 9.0	27-44-04-02	eClass 9.1	27-44-04-02

**OMNIMATE Signal - series BC/SC 3.81  
BCF 3.81/03/180F SN OR BX**

**Weidmüller Interface GmbH & Co. KG**  
 Klingenbergstraße 16  
 D-32758 Detmold  
 Germany  
 Fon: +49 5231 14-0  
 Fax: +49 5231 14-292083  
 www.weidmueller.com

**Technical data****Notes**

Notes	<ul style="list-style-type: none"> <li>• Additional colours on request</li> <li>• Crimp shape A for wire-end ferrules with crimping tools PZ 1,5 (order no. 9005990000) or PZ 6/5 (order no. 9011460000) for larger wire cross-sections recommended.</li> <li>• Rated current related to rated cross-section &amp; min. No. of poles.</li> <li>• Wire end ferrule without plastic collar to DIN 46228/1</li> <li>• Wire end ferrule with plastic collar to DIN 46228/4</li> <li>• P on drawing = pitch</li> <li>• Rated data refer only to the component itself. Clearance and creepage distances to other components are to be designed in accordance with the relevant application standards.</li> <li>• Conductors suitable for connection: 1.5 mm<sup>2</sup> with wire-end ferrule with plastic collar, DIN 46 228/1, with a rated voltage of 125V/2.5 kV with III/3 or 250 V/2.5 kV with II/2</li> </ul>
IPC conformity	Conformity: The products are developed, manufactured and delivered according international recognized standards and norms and comply with the assured properties in the data sheet resp. fulfill decorative properties in accordance with IPC-A-610 "Class 2". Further claims on the products can be evaluated on request.

**Approvals**

Approvals



ROHS

Conform

**Downloads**

Approval/Certificate/Document of Conformity

[Declaration of the Manufacturer](#)

Brochure/Catalogue

[FL DRIVES EN](#)  
[MB DEVICE MANUF. EN](#)  
[FL DRIVES DE](#)  
[CAT 2 PORTFOLIOGUIDE EN](#)  
[FL BUILDING SAFETY EN](#)  
[FL APPL LED LIGHTING EN](#)  
[FL INDUSTR.CONTROLS EN](#)  
[FL MACHINE SAFETY EN](#)  
[FL HEATING ELECTR EN](#)  
[FL APPL INVERTER EN](#)  
[FL\\_BASE\\_STATION\\_EN](#)  
[FL ELEVATOR EN](#)  
[FL POWER SUPPLY EN](#)  
[FL 72H SAMPLE SER EN](#)  
[PO OMNIMATE EN](#)

User Documentation

[BPZL\\_PUSH\\_IN\\_Connectors\\_BCF\\_3\\_81\\_EN](#)

White Paper wire connection

[Download Whitepaper](#)

**OMNIMATE Signal - series BC/SC 3.81  
BCF 3.81/03/180F SN OR BX**

**Weidmüller Interface GmbH & Co. KG**  
Klingenbergstraße 16  
D-32758 Detmold  
Germany  
Fon: +49 5231 14-0  
Fax: +49 5231 14-292083  
www.weidmueller.com

**Drawings**

**Dimensional drawing**

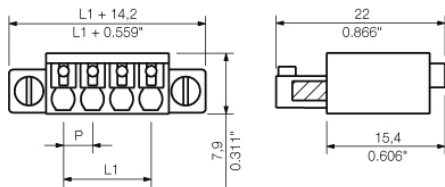

**Example of use**

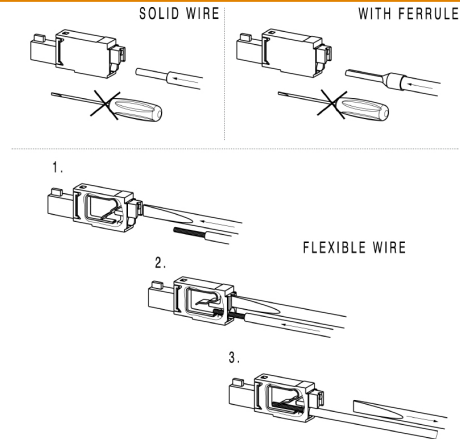

**Graph**

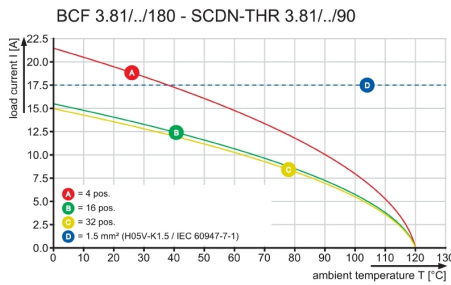

**Graph**

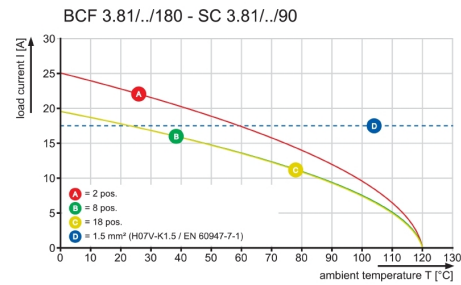

**Graph**

