

Click [here](#) for production status of specific part numbers.

MAX17262

5.2µA 1-Cell Fuel Gauge with ModelGauge m5 EZ and Internal Current Sensing

General Description

The MAX17262 is an ultra-low power fuel-gauge IC which implements the Maxim ModelGauge™ m5 algorithm. The IC monitors a single-cell battery pack and supports internal current sensing for up to 3.1A pulse current. The IC provides best performance for batteries with 100mAh to 6Ahr capacity.

The ModelGauge m5 EZ makes fuel-gauge implementation easy by eliminating battery characterization requirements and simplifying host software interaction. The ModelGauge m5 EZ robust algorithm provides tolerance against battery diversity for most lithium batteries and applications.

The ModelGauge m5 EZ algorithm combines the short-term accuracy and linearity of a coulomb counter with the long-term stability of a voltage-based fuel gauge, along with temperature compensation to provide industry-leading fuel-gauge accuracy. The IC automatically compensates for cell-aging, temperature, and discharge rate, and provides accurate state-of-charge (SOC) in percentage (%) and remaining capacity in milliampere-hours (mAh) over a wide range of operating conditions. As the battery approaches the critical region near empty, the ModelGauge m5 algorithm invokes a special correction mechanism that eliminates any error. The IC provides accurate estimation of time-to-empty and time-to-full and provides three methods for reporting the age of the battery: reduction in capacity, increase in battery resistance, and cycle odometer.

The IC provides precision measurements of current, voltage, and temperature. The temperature of the battery pack is measured using an internal temperature sensor or external thermistor. A 2-wire I²C interface provides access to data and control registers. The IC is available in a tiny lead-free 0.4mm pitch, 1.5mm x 1.5mm, 9-pin wafer-level package (WLP).

Applications

- Wearables and Smartwatches
- Bluetooth Headset Cases
- Health and Fitness Monitors
- Medical Devices
- Handheld Computers and Terminals
- Home and Building Automation, Sensors
- Toys

ModelGauge is a trademark of Maxim Integrated Products, Inc.

Benefits and Features

- ModelGauge m5 EZ
 - No Characterization Required for EZ Performance
 - Robust Against Battery Variation
 - Eliminates Error Near Empty Voltage
 - Eliminates Coulomb-Counter Drift
 - Compensates for Age, Current, Temperature
 - Does Not Require Empty, Full, or Idle States
- Low 5.2µA Operating Current
- Integrated Internal Current Sensing
 - 7mΩ Typical, up to 3.1A Pulse Currents
- Supports Li+ and Variants Including LiFePO₄
- Thermistor or ±1°C Internal Temperature
- Dynamic Power Estimates Power Capability During Discharge
- Time-to-Empty and Time-to-Full Estimation
 - Constant Power or Constant Current
- Predicts Remaining Capacity Under Theoretical Load
- No Calibration Required
- Alert Indicator for Voltage, SOC, Temperature, Current, and 1% SOC Change

Ordering Information appears at end of data sheet.

Simple Fuel-Gauge Circuit Diagram

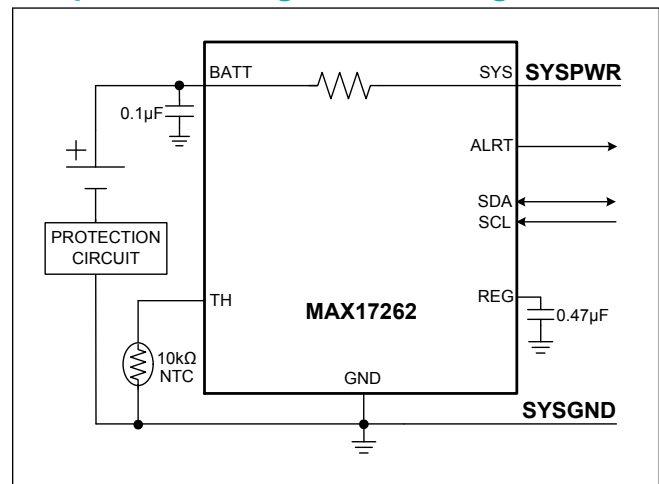

TABLE OF CONTENTS

| | |
|--|----|
| General Description | 1 |
| Applications | 1 |
| Benefits and Features | 1 |
| Simple Fuel-Gauge Circuit Diagram | 1 |
| Absolute Maximum Ratings | 6 |
| Package Information | 6 |
| WLP | 6 |
| Electrical Characteristics | 7 |
| Typical Operating Characteristics | 10 |
| Pin Configuration(s) | 12 |
| Pin Descriptions | 12 |
| Functional Diagram | 13 |
| Detailed Description | 14 |
| ModelGauge m5 EZ Performance | 14 |
| Application Notes | 15 |
| Standard Register Formats | 15 |
| ModelGauge m5 EZ Configuration Registers | 16 |
| DesignCap Register (18h) | 16 |
| VEmpty Register (3Ah) | 16 |
| ModelCfg Register (DBh) | 17 |
| IChgTerm Register (1Eh) | 17 |
| Config Register (1Dh) and Config2 Register (BBh) | 17 |
| ModelGauge m5 Algorithm | 19 |
| ModelGauge m5 Algorithm Output Registers | 20 |
| RepCap Register (05h) | 20 |
| RepSOC Register (06h) | 21 |
| FullCapRep Register (10h) | 21 |
| TTE Register (11h) | 21 |
| TTF Register (20h) | 21 |
| Cycles Register (17h) | 21 |
| Status Register (00h) | 21 |
| Analog Measurements | 22 |
| Voltage Measurement | 22 |
| VCell Register (09h) | 22 |
| AvgVCell Register (19h) | 22 |
| MaxMinVolt Register (1Bh) | 22 |
| Current Measurement | 23 |

TABLE OF CONTENTS (CONTINUED)

| | |
|--------------------------------------|----|
| Current Register (0Ah) | 24 |
| AvgCurrent Register (0Bh) | 24 |
| MaxMinCurr Register (1Ch) | 24 |
| Temperature Measurement | 25 |
| Temp Register (08h) | 25 |
| AvgTA Register (16h) | 25 |
| MaxMinTemp Register (1Ah) | 25 |
| DieTemp Register (034h) | 26 |
| Power Register (B1h) | 26 |
| AvgPower Register (B3h) | 26 |
| Alert Function | 26 |
| VAIrtTh Register (01h) | 26 |
| TAIrtTh Register (02h) | 27 |
| SAIrtTh Register (03h) | 27 |
| IAIrtTh Register (B4h) | 27 |
| Serial Number Feature | 28 |
| ModelGauge m5 Memory Space | 28 |
| Layout Guidelines | 29 |
| Ordering Information | 31 |
| Revision History | 32 |

LIST OF FIGURES

| | |
|--|----|
| Figure 1. ModelGauge m5 EZ Configuration Performance | 15 |
| Figure 2. ModelGauge m5 Algorithm | 20 |
| Figure 3. Current Limit Based On Utilization Patterns. | 24 |
| Figure 4. MAX17262 Layout Guide | 30 |

LIST OF TABLES

| | |
|--|----|
| Table 1. ModelGauge m5 EZ Performance | 14 |
| Table 2. ModelGauge m5 Register Standard Resolutions | 15 |
| Table 3. VEmpty (3Ah) Format | 16 |
| Table 4. ModelCFG (DBh) Format | 17 |
| Table 5. Config (1Dh) Format | 17 |
| Table 6. Config2 (BBh) Format | 17 |
| Table 7. Status (00h) Format | 21 |
| Table 8. MaxMinVolt (1Bh) Format | 23 |
| Table 9. MaxMinCurr (1Ch) Format | 25 |
| Table 10. MaxMinTemp (1Ah) Format | 26 |
| Table 11. VAirtTh (01h) Format. | 27 |
| Table 12. TAirtTh (02h) Format. | 27 |
| Table 13. SAirtTh (03h) Format. | 27 |
| Table 14. IAirtTh (B4h) Format | 28 |
| Table 15. Serial Number Format | 28 |
| Table 16. ModelGauge m5 Register Memory Map | 28 |

Absolute Maximum Ratings

| | | | |
|-------------------------------------|-------------------------------------|--|--------|
| BATT to GND | -0.3V to +6V | Continuous Source Current for TH | 1mA |
| ALRT to GND | -0.3V to +17V | Continuous Sink Current for SDA, ALRT | 20mA |
| REG to GND | -0.3V to +2.2V | Lead Temperature (soldering 10s)..... | +300°C |
| TH to GND | -0.3 V to V _{BATT} + 0.3 V | Current Limit of Sense Resistor (Continuous current at 100% utilization (Note 1))..... | 1.7A |
| CSN to GND | -0.3V to V _{BATT} + 0.3V | Current Limit of Sense Resistor (Continuous current at 10% utilization (Note 1))..... | 2.4A |
| CSPL to GND | -0.3V to +0.3V | Current Limit of Sense Resistor (Peak pulsed current, 250ms maximum pulse width, 10% maximum duty cycle, 1% utilization (Note 1))..... | 3.1A |
| SDA, SCL to GND | -0.3V to +6V | | |
| SYS to GND | -0.3V to +6V | | |
| Operating Temperature Range | -40°C to +85°C | | |
| Junction Temperature | +150°C | | |
| Storage Temperature Range..... | -55°C to +125°C | | |
| Soldering Temperature (reflow)..... | +260°C | | |

Note 1: Guaranteed by design and not production tested. Total available utilization is 100,000 hours. Utilization is proportionately cumulative. See the [Current Measurement](#) section for a detailed explanation of the current limit under different utilization patterns.

Stresses beyond those listed under "Absolute Maximum Ratings" may cause permanent damage to the device. These are stress ratings only, and functional operation of the device at these or any other conditions beyond those indicated in the operational sections of the specifications is not implied. Exposure to absolute maximum rating conditions for extended periods may affect device reliability.

Package Information

WLP

| | |
|--|--|
| Package Code | W91G1+2 |
| Outline Number | 21-100168 |
| Land Pattern Number | Refer to Application Note 1891 |
| Thermal Resistance, Four-Layer Board: | |
| Junction to Ambient (θ _{JA}) | 83.98°C/W |
| Junction to Case (θ _{JC}) | NA |

For the latest package outline information and land patterns (footprints), go to www.maximintegrated.com/packages. Note that a "+", "#", or "-" in the package code indicates RoHS status only. Package drawings may show a different suffix character, but the drawing pertains to the package regardless of RoHS status.

Package thermal resistances were obtained using the method described in JEDEC specification JESD51-7, using a four-layer board. For detailed information on package thermal considerations, refer to www.maximintegrated.com/thermal-tutorial.

Electrical Characteristics

($V_{BATT} = 2.3V$ to $4.9V$, $T_A = -40^{\circ}C$ to $+85^{\circ}C$, typical value for T_A is $+25^{\circ}C$. Limits are 100% tested at $T_A = +25^{\circ}C$. The operating temperature range and relevant supply voltage range are guaranteed by design and characterization. Specifications marked "GBD" are guaranteed by design and not production tested.)

| PARAMETER | SYMBOL | CONDITIONS | MIN | TYP | MAX | UNITS |
|---|--------------|--|------|-----------|------|--------------|
| POWER SUPPLY | | | | | | |
| Supply Voltage | V_{BATT} | (<i>Note 2</i>) | 2.3 | | 4.9 | V |
| Shutdown Supply Current | I_{DD0} | $T_A \leq +50^{\circ}C$ | | 0.5 | 0.9 | μA |
| Hibernate Supply Current | I_{DD1} | $T_A \leq +50^{\circ}C$, average current | | 5.2 | 12 | μA |
| Active Supply Current | I_{DD2} | $T_A \leq +50^{\circ}C$, average current not including thermistor measurement current | | 16 | 30 | μA |
| Regulation Voltage | V_{REG} | | | 1.8 | | V |
| Startup Voltage | V_{BATTSU} | | | | 3 | V |
| ANALOG-TO-DIGITAL CONVERSION | | | | | | |
| BATT Measurement Error | V_{GERR} | $T_A = +25^{\circ}C$ | -7.5 | | +7.5 | mV |
| | | $-40^{\circ}C \leq T_A \leq +85^{\circ}C$ | -20 | | +20 | |
| BATT Measurement Resolution | V_{LSB} | | | 78.125 | | μV |
| BATT Measurement Range | V_{FS} | | 2.3 | | 4.9 | V |
| Sense Resistance | R_{SNS} | $T_A = +25^{\circ}C$ | | 7 | | m Ω |
| Current Measurement Offset Error | I_{OERR} | Zero current, long term average | | ± 1 | | mA |
| Current Measurement Resolution | I_{LSB} | | | 0.15625 | | mA |
| Current Measurement Gain Error | I_{GERR} | (<i>Note 9</i>) | | ± 2.5 | | % of Reading |
| Current Measurement Error | I_{ERR} | $T_A \leq +50^{\circ}C$, 0.5A and 1A (<i>Note 9</i>) | -3 | | +3 | % of Reading |
| Internal Temperature Measurement Error | T_{IGERR} | $-40^{\circ}C \leq T_A \leq +85^{\circ}C$ | | ± 1 | | $^{\circ}C$ |
| Internal Temperature Measurement Resolution | T_{ILSB} | | | 0.00391 | | $^{\circ}C$ |
| INPUT/OUTPUT | | | | | | |
| External Thermistance Resistance | R_{EXT10} | Config.R100 = 0 | | 10 | | k Ω |
| | R_{EXT100} | Config.R100 = 1 | | 100 | | |
| Output Drive Low, ALRT, SDA | V_{OL} | $I_{OL} = 4mA$, $V_{BATT} = 2.3V$ | | | 0.4 | V |
| Input Logic High, ALRT, SCL, SDA | V_{IH} | | 1.5 | | | V |
| Input Logic Low, ALRT, SCL, SDA | V_{IL} | | | | 0.5 | V |

Electrical Characteristics (continued)

($V_{BATT} = 2.3V$ to $4.9V$, $T_A = -40^\circ C$ to $+85^\circ C$, typical value for T_A is $+25^\circ C$. Limits are 100% tested at $T_A = +25^\circ C$. The operating temperature range and relevant supply voltage range are guaranteed by design and characterization. Specifications marked "GBD" are guaranteed by design and not production tested.)

| PARAMETER | SYMBOL | CONDITIONS | MIN | TYP | MAX | UNITS |
|--|---------------|--|------|------|-----|-------|
| Battery-Detach Detection Threshold | V_{DET} | Measured as a fraction of V_{BATT} on TH rising | 91 | 96.2 | 99 | % |
| Battery-Detach Detection Threshold Hysteresis | $V_{DET-HYS}$ | Measured as a fraction of V_{BATT} on TH falling | | 1 | | % |
| Battery-Detach Comparator Delay | t_{TOFF} | TH step from 70% to 100% of V_{BATT} (Alrtp = 0, EnAIN = 1, FTHRM = 1) | | | 100 | µs |
| LEAKAGE | | | | | | |
| Leakage Current, CSN, ALRT | I_{LEAK} | $V_{ALRT} < 15V$ | -1 | | +1 | µA |
| Input Pulldown Current | I_{PD} | $V_{SDA} = 0.4V$, $V_{SCL} = 0.4V$ | 0.05 | 0.2 | 0.4 | µA |
| 2-WIRE INTERFACE | | | | | | |
| SCL Clock Frequency | f_{SCL} | (Note 3) | 0 | | 400 | kHz |
| Bus Free Time Between a STOP and START Condition | t_{BUF} | | 1.3 | | | µs |
| Hold Time (Repeated) START Condition | $t_{HD:STA}$ | (Note 4) | 0.6 | | | µs |
| Low Period of SCL Clock | t_{LOW} | | 1.3 | | | µs |
| High Period of SCL Clock | t_{HIGH} | | 0.6 | | | µs |
| Setup Time for a Repeated START Condition | $t_{SU:STA}$ | | 0.6 | | | µs |
| Data Hold Time | $t_{HD:DAT}$ | (Note 5 , Note 6) | 0 | | 0.9 | µs |
| Data Setup Time | $t_{SU:DAT}$ | (Note 5) | 100 | | | ns |
| Rise Time of Both SDA and SCL Signals | t_R | | 5 | | 300 | ns |
| Fall Time of Both SDA and SCL Signals | t_F | | 5 | | 300 | ns |
| Setup Time for STOP Condition | $t_{SU:STO}$ | | 0.6 | | | µs |
| Spike Pulse Width Suppressed by Input Filter | t_{SP} | (Note 7) | | | 50 | ns |
| Capacitive Load for Each Bus Line | C_B | (Note 8) | | | 400 | pF |
| SCL, SDA Input Capacitance | C_{BIN} | | | 6 | | pF |

Electrical Characteristics (continued)

(V_{BATT} = 2.3V to 4.9V, T_A = -40°C to +85°C, typical value for T_A is +25°C. Limits are 100% tested at T_A = +25°C. The operating temperature range and relevant supply voltage range are guaranteed by design and characterization. Specifications marked "GBD" are guaranteed by design and not production tested.)

| PARAMETER | SYMBOL | CONDITIONS | MIN | TYP | MAX | UNITS |
|--------------------|-----------|---------------------------|------|-----|-----|-------|
| TIMING | | | | | | |
| Time-Base Accuracy | t_{ERR} | $T_A = +25^\circ\text{C}$ | -1 | | +1 | % |
| TH Precharge Time | t_{PRE} | | 8.48 | | | ms |

Note 2: All voltages are referenced to GND.

Note 3: Timing must be fast enough to prevent the IC from entering shutdown mode due to bus low for a period greater than the shutdown timer setting.

Note 4: f_{SCL} must meet the minimum clock low time plus the rise/fall times.

Note 5: The maximum $t_{HD:DAT}$ has only to be met if the device does not stretch the low period (t_{LOW}) of the SCL signal.

Note 6: This device internally provides a hold time of at least 100ns for the SDA signal (refer to the minimum V_{IH} of the SCL signal) to bridge the undefined region of the falling edge of SCL.

Note 7: Filters on SDA and SCL suppress noise spikes at the input buffers and delay the sampling instant.

Note 8: C_B represents total capacitance of one bus line in pF.

Note 9: Guaranteed by design and not production tested.

Typical Operating Characteristics

(T_A = +25°C, unless otherwise noted.)

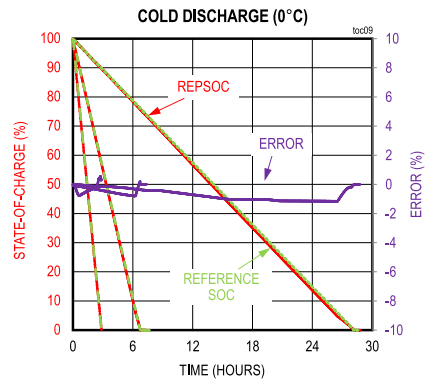
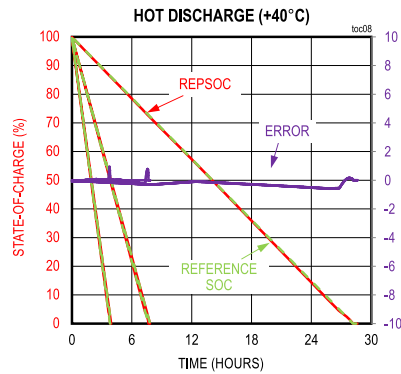
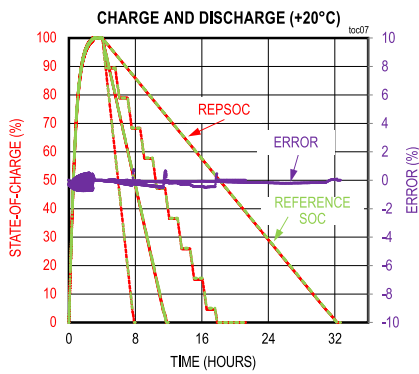
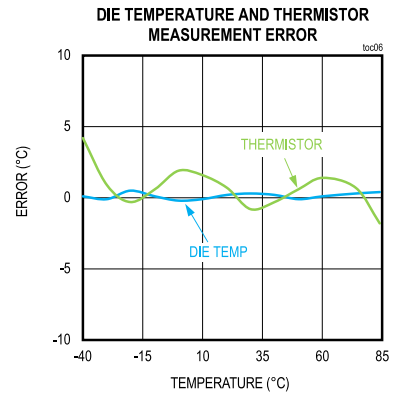
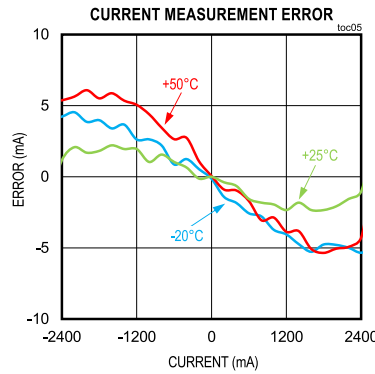
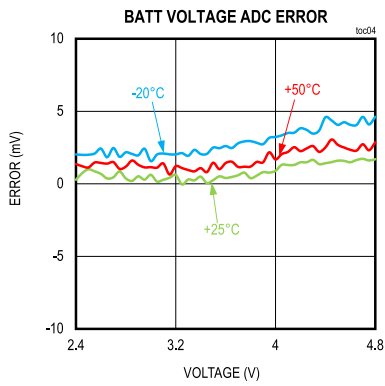
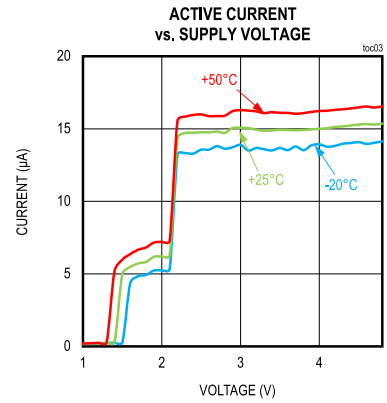
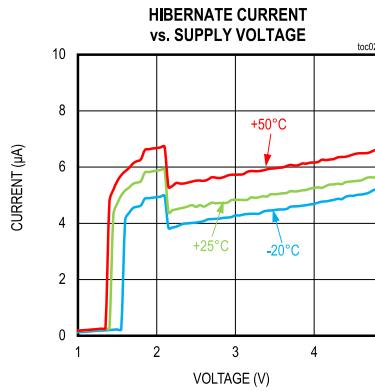
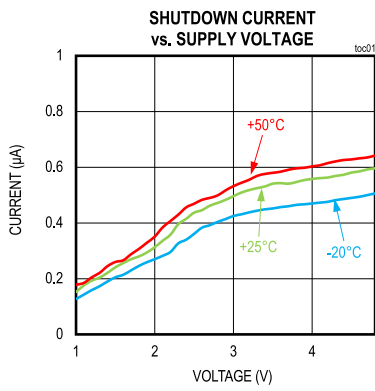

Typical Operating Characteristics (continued)

(T_A = +25°C, unless otherwise noted.)

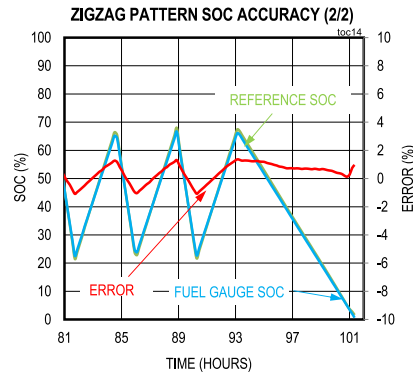
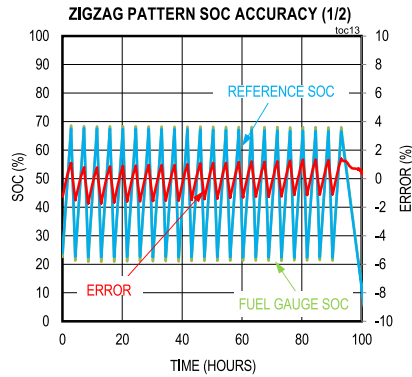
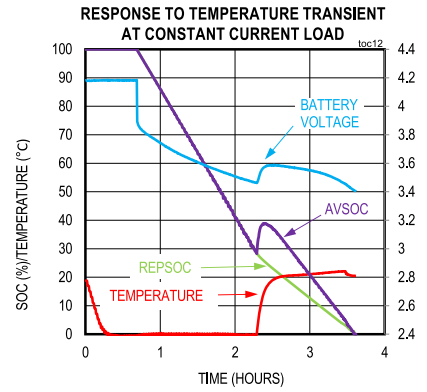
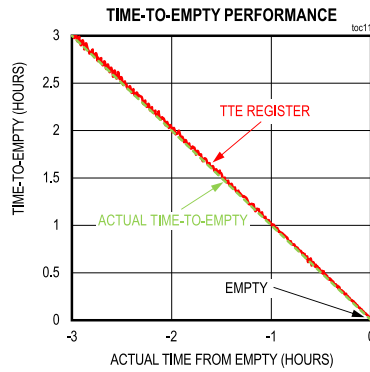
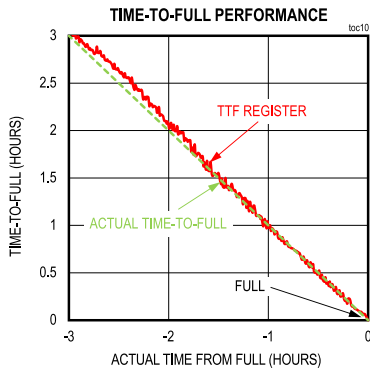

Pin Configuration(s)

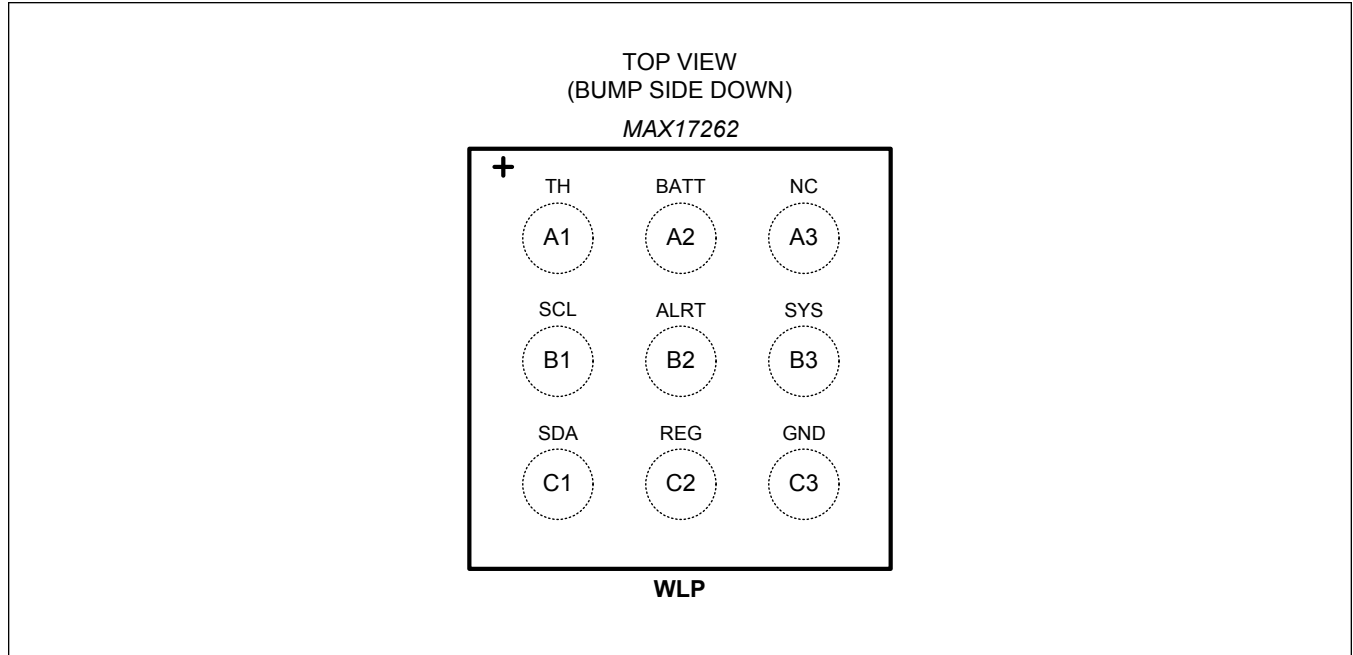

Pin Descriptions

| PIN | NAME | FUNCTION |
|-----|------|--|
| A3 | NC | No Connection. |
| A1 | TH | Thermistor Input. Connect a thermistor from TH to GND. TH also provides battery insertion/removal detection. Connect to BATT if not used. |
| B1 | SCL | Serial Clock Input. 2-wire clock line. Input only. SCL has an internal pulldown (I _{PD}) for sensing disconnection. |
| C1 | SDA | Serial Data Input/Output. 2-wire data line. Open-drain output driver. SDA has an internal pulldown (I _{PD}) for sensing disconnection. |
| B3 | SYS | System Power. Connect to system load. |
| A2 | BATT | IC Power Supply and Battery Voltage Sense Input. Connect to the positive terminal of a battery cell. Bypass with a 0.1µF capacitor to GND. |
| C3 | GND | IC Ground. |
| C2 | REG | Internal 1.8V Regulator Output. Bypass with an external 0.47µF capacitor to GND. Do not load externally. |
| B2 | ALRT | Alert Output. The ALRT pin is an open-drain active-low output which indicates fuel-gauge alerts. Connect to GND if not used. |

Functional Diagram

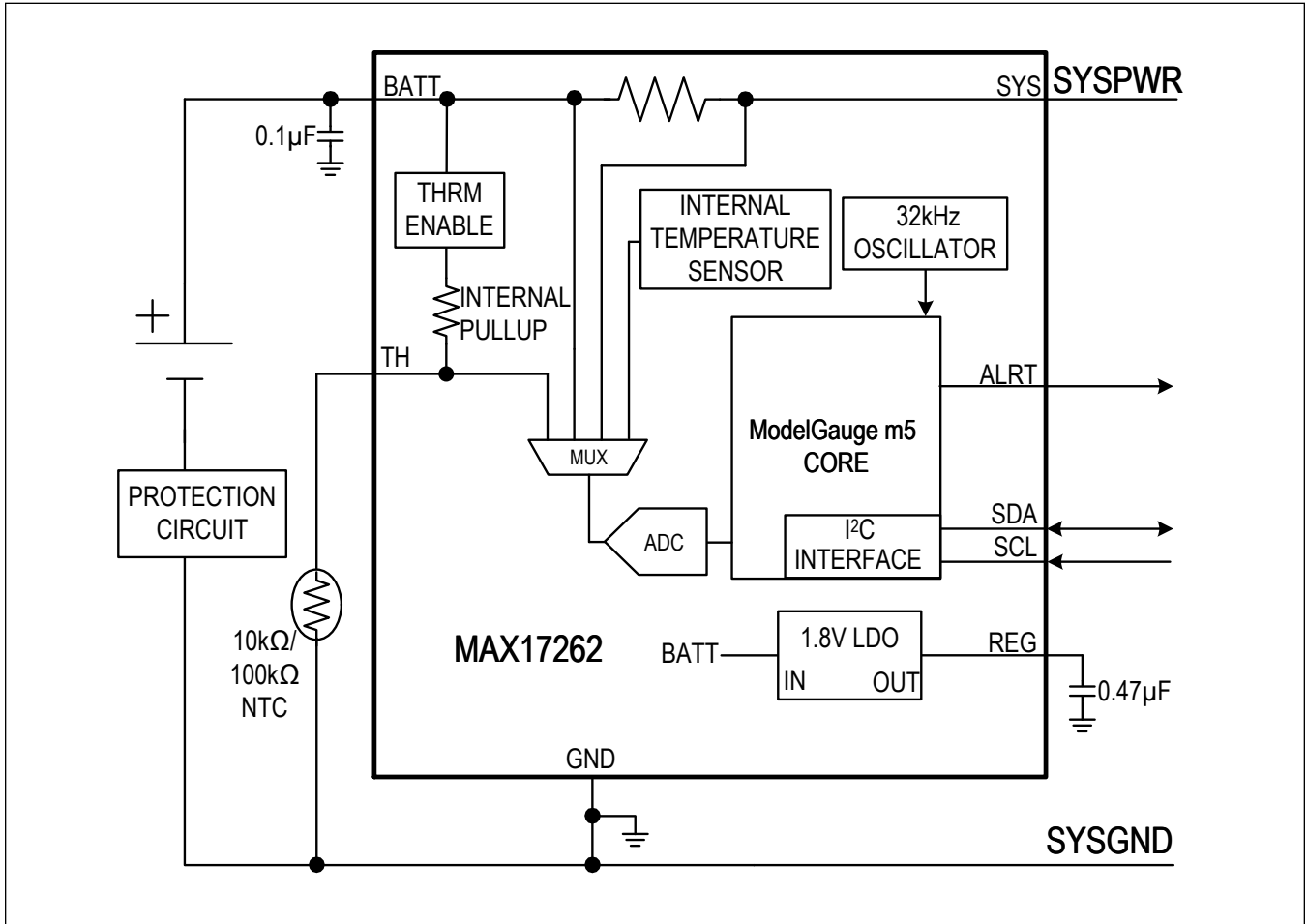

Detailed Description

The MAX17262 is an ultra-low power fuel gauge IC which implements the Maxim ModelGauge m5 EZ algorithm. The IC measures voltage, current, and temperature accurately to produce fuel gauge results. The ModelGauge m5 EZ robust algorithm provides tolerance against battery diversity. This additional robustness enables simpler implementation for most applications and batteries by avoiding time-consuming battery characterization. The IC features internal current measurement for up to 3.1A pulse currents. The IC provides best performance for batteries with 100mAh to 6Ah capacity.

The ModelGauge m5 algorithm combines the short-term accuracy and linearity of a coulomb-counter with the long-term stability of a voltage-based fuel gauge, along with temperature compensation to provide industry-leading fuel-gauge accuracy. The IC automatically compensates for aging, temperature, and discharge rate and provides accurate state-of-charge (SOC) in percentage (%) and remaining capacity in milliampere-hours (mAh) over a wide range of operating conditions. Fuel-gauge error always converges to 0% as the cell approaches empty.

The IC has a register set that is compatible with Intel's DBPT v2 dynamic power standard. This allows the system designer to safely estimate the maximum allowed CPU turbo-boost power level in complex power conditions. The IC provides accurate estimation of time-to-empty and time-to-full and provides three methods for reporting the age of the battery: reduction in capacity, increase in battery resistance, and cycle odometer.

The IC contains a unique serial number. It can be used for cloud-based authentication. See the [Serial Number Feature](#) section for more information.

Communication to the host occurs over standard I²C interface. For information about I²C communication, refer to the [User Guide 6597: MAX1726x ModelGauge m5 EZ User Guide](#).

ModelGauge m5 EZ Performance

ModelGauge m5 EZ performance provides plug-and-play operation when the IC is connected to most lithium batteries. While the IC can be custom tuned to the application's specific battery through a characterization process for ideal performance, the IC has the ability to provide good performance for most applications with no custom characterization required. [Table 1](#) and [Figure 1](#) show the performance of the ModelGauge m5 algorithm in applications using ModelGauge m5 EZ configuration.

The ModelGauge m5 EZ provides good performance for most cell types. For some chemistries, such as lithium-iron-phosphate (LiFePO₄) and Panasonic NCR/NCA series cells, it is suggested that the customer request a custom model from Maxim for best performance.

For even better fuel-gauging accuracy than ModelGauge m5 EZ, contact Maxim for information regarding cell characterization.

Table 1. ModelGauge m5 EZ Performance

| DESCRIPTION | AFTER FIRST CYCLE* (%) | AFTER SECOND CYCLE* (%) |
|--------------------------------|------------------------|-------------------------|
| Tests with less than 3% error | 95 | 97 |
| Tests with less than 5% error | 98.7 | 99 |
| Tests with less than 10% error | 100 | 100 |

*Test conditions: +20°C and +40°C, run time of > 3 hours.

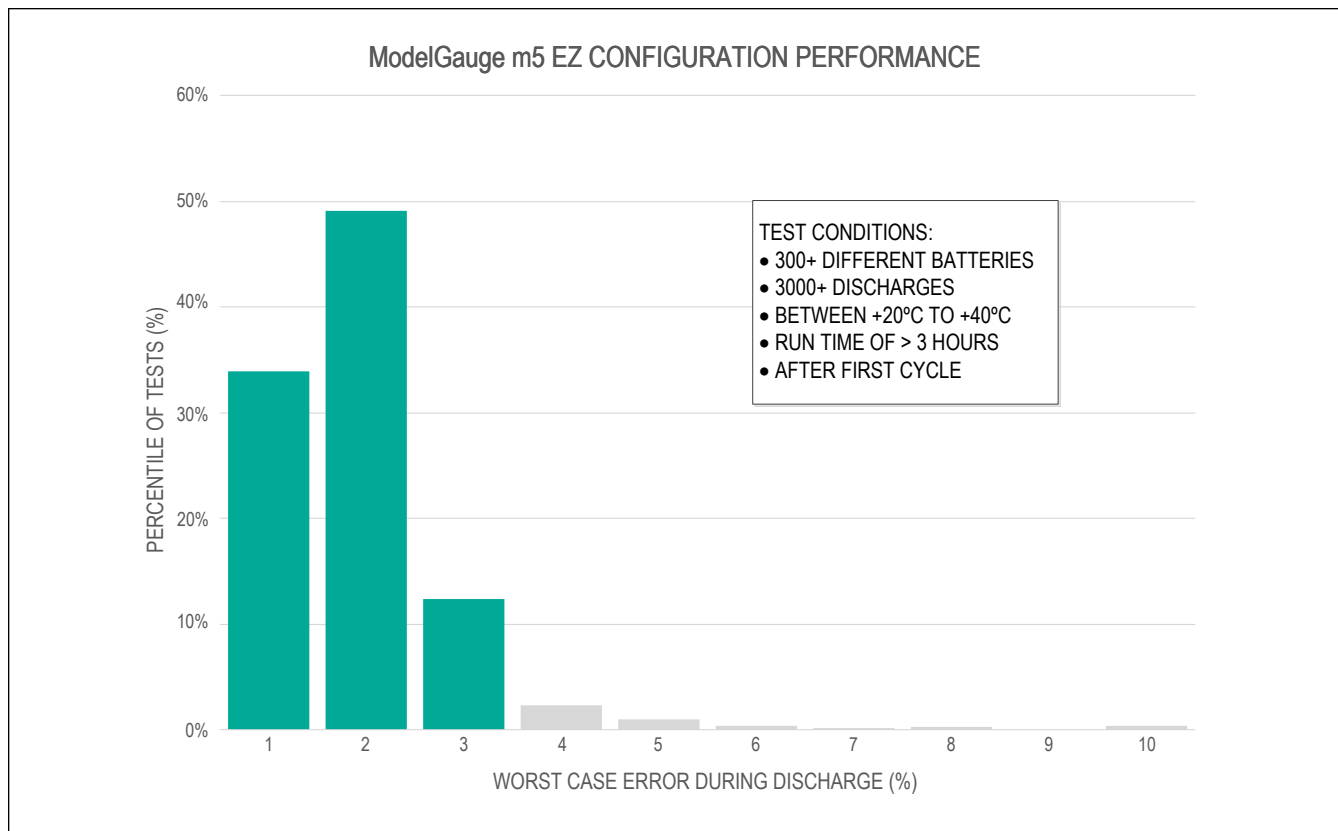

Figure 1. ModelGauge m5 EZ Configuration Performance

Application Notes

Refer to the following application notes for additional reference material:

- [User Guide 6597: MAX1726x ModelGauge m5 EZ User Guide](#)
 - Documents full register set
 - More details about ModelGauge m5 algorithm
 - Discusses additional applications
- [User Guide 6595: MAX1726x Software Implementation Guide](#)
 - Guidelines for software drivers including example code

Standard Register Formats

Unless otherwise stated during a given register's description, all IC registers follow the same format depending on the type of register. See [Table 2](#) for the resolution and range of any register described hereafter.

Table 2. ModelGauge m5 Register Standard Resolutions

| REGISTER TYPE | LSb SIZE | MINIMUM VALUE | MAXIMUM VALUE | NOTES |
|---------------|----------|---------------|---------------|--|
| Capacity | 0.5mAh | 0.0mAh | 32767.5mAh | |
| Percentage | 1/256% | 0.0% | 255.9961% | 1% LSb when reading only the upper byte. |

Table 2. ModelGauge m5 Register Standard Resolutions (continued)

| REGISTER TYPE | LSb SIZE | MINIMUM VALUE | MAXIMUM VALUE | NOTES |
|---------------|-----------|---------------|---------------|---|
| Voltage | 1.25mV/16 | 0.0V | 5.11992V | |
| Current | 156.25µA | -5.12A | 5.12A | Signed two's-complement format. |
| Temperature | 1/256°C | -128.0°C | 127.996°C | Signed two's-complement format. 1°C LSb when reading only the upper byte. |
| Resistance | 1/4096Ω | 0.0Ω | 15.99976Ω | |
| Time | 5.625s | 0.0s | 102.3984h | |
| Special | | | | Format details are included with the register description. |

ModelGauge m5 EZ Configuration Registers

The following registers are inputs to the ModelGauge m5 algorithm and store characterization information for the application cells as well as important application specific parameters. They are described briefly here.

Only the following information is required for configuring ModelGauge m5 EZ:

- Label Capacity—DesignCap
- Empty Voltage—VEmpty
- Charge Termination Current—I_{CHGTerm}

Refer to the [MAX1726x Software Implementation Guide](#) for more details on how to initialize the fuel gauge.

DesignCap Register (18h)

Register Type: Capacity

Initial value: 0x0BB8

The DesignCap register holds the nominal capacity of the cell. The IC provides best performance for batteries with 100mAh to 6Ah capacity.

VEmpty Register (3Ah)

Register Type: Special

Initial Value: 0xA561 (3.3V/3.88V)

The VEmpty register sets thresholds related to empty detection during operation. [Table 3](#) shows the register format.

Table 3. VEmpty (3Ah) Format

| D15 | D14 | D13 | D12 | D11 | D10 | D9 | D8 | D7 | D6 | D5 | D4 | D3 | D2 | D1 | D0 |
|-----|-----|-----|-----|-----|-----|----|----|----|----|----|----|----|----|----|----|
| VE | | | | | | | | VR | | | | | | | |

VE: Empty voltage target, during load. The fuel gauge provides capacity and percentage relative to the empty voltage target, eventually declaring 0% at VE. A 10mV resolution gives a 0V to 5.11V range. This value defaults to 3.3V after reset.

VR: Recovery voltage. Sets the voltage level for clearing empty detection. Once the cell voltage rises above this point, empty voltage detection is reenabled. A 40mV resolution gives a 0V to 5.08V range. This value defaults to 3.88V, which is recommended for most applications.

ModelCfg Register (DBh)

Register Type: Special

The ModelCFG register controls basic options of the EZ algorithm. [Table 4](#) shows the register format.**Table 4. ModelCFG (DBh) Format**

| D15 | D14 | D13 | D12 | D11 | D10 | D9 | D8 | D7 | D6 | D5 | D4 | D3 | D2 | D1 | D0 |
|---------|-----|------|-----|-----|------|----|----|---------|----|----|----|----|----|----|----|
| Refresh | 0 | R100 | 0 | 0 | VChg | 0 | 0 | ModelID | | | 0 | 1 | 0 | 0 | |

Refresh: Set Refresh to 1 to command the model reload. After completion the MAX17262 clears Refresh to 0.**R100:** if using 100kΩ NTC, set R100 = 1; if using 10kΩ NTC, set R100 = 0.**ModelID:** Choose from one of the following Lithium models. For the majority of batteries, use ModelID = 0.

ModelID = 0: Use for most lithium cobalt-oxide variants (a large majority of lithium in the market-place). Supported by EZ without characterization.

ModelID = 2: Use for lithium NCR or NCA cells such as Panasonic. Custom characterization is recommended in this case.

ModelID = 6: Use for lithium iron-phosphate (LiFePO₄). Custom characterization is recommended in this case.**VChg:** Set VChg to 1 for charge voltage higher than 4.25V (4.3V–4.4V). Set VChg to 0 for 4.2V charge voltage.**ICHgTerm Register (1Eh)**

Register Type: Current

Initial Value: 0x0640 (500mA)

The IChgTerm register allows the device to detect when charge termination has occurred. Program IChgTerm to the exact charge termination current used in the application.

Refer to the *End-of-Charge Detection* section of the [User Guide 6597: MAX1726x ModelGauge m5 EZ User Guide](#) for more details.**Config Register (1Dh) and Config2 Register (BBh)**

Register Type: Special

Initial Value: 0x2210 for Config, 0x3658 for Config2

The Config registers hold all shutdown enable, alert enable, and temperature enable control bits. Writing a bit location enables the corresponding function within one task period. (One task period is 175ms in active mode, and 5.6 seconds in hibernate mode by default.) [Table 5](#) and [Table 6](#) show the register formats.**Table 5. Config (1Dh) Format**

| D15 | D14 | D13 | D12 | D11 | D10 | D9 | D8 | D7 | D6 | D5 | D4 | D3 | D2 | D1 | D0 |
|------|-----|-----|-----|-----|------|-----|-----|------|--------|----|-------|-------|-----|-----|-----|
| TSel | SS | TS | VS | IS | THSH | Ten | Tex | SHDN | COMMSH | 0 | ETHRM | FTHRM | Aen | Bei | Ber |

Table 6. Config2 (BBh) Format

| D15 | D14 | D13 | D12 | D11 | D10 | D9 | D8 | D7 | D6 | D5 | D4 | D3 | D2 | D1 | D0 |
|-----|-----|-----|-----|-----|-----|----|----|----|----|----|----|----|----|----|----|
|-----|-----|-----|-----|-----|-----|----|----|----|----|----|----|----|----|----|----|

Table 6. Config2 (BBh) Format (continued)

| | | | | | | | | | | | |
|---|---|----------|------|------|--------|---------|-------|---|-------|--------|---|
| 0 | 0 | AtRateEn | DPEn | POWR | dSOCen | TAlrtEn | LDMdl | 1 | DRCfg | CPMode | 0 |
|---|---|----------|------|------|--------|---------|-------|---|-------|--------|---|

0: Bit must be written 0. Do not write 1.

1: Bit must be written 1. Do not write 0.

TSEL: Temperature sensor select. Set to 0 to use internal die temperature. Set to 1 to use temperature information from thermistor. ETHRM bit must be set to 1 when TSEL is 1.

SS: SOC ALRT Sticky. When SS = 1, SOC alerts can only be cleared through software. When SS = 0, SOC alerts are cleared automatically when the threshold is no longer exceeded.

TS: Temperature ALRT Sticky. When TS = 1, temperature alerts can only be cleared through software. When TS = 0, temperature alerts are cleared automatically when the threshold is no longer exceeded.

VS: Voltage ALRT Sticky. When VS = 1, voltage alerts can only be cleared through software. When VS = 0, voltage alerts are cleared automatically when the threshold is no longer exceeded.

IS: Current ALRT Sticky. When IS = 1, current alerts can only be cleared through software. When IS = 0, current alerts are cleared automatically when the threshold is no longer exceeded.

THSH: TH Pin Shutdown. Set to 1 to enable device shutdown when the IC is mounted host-side and the battery is removed. The IC enters shutdown if the TH pin remains high ($V_{TH} > V_{BATT} - V_{DET}$) for longer than the timeout of the ShdnTimer register. This also configures the device to wake up when TH is pulled low with a thermistor on-cell insertion. Note that if COMMSH and AINSH are both set to 0, the device wakes up on any edge of SDA.

Ten: Enable Temperature Channel. Set to 1 and set ETHRM or FTHRM to 1 to enable temperature measurement.

Tex: Temperature External. When set to 1, the fuel gauge requires external temperature measurements to be written from the host. When set to 0, the ICs own measurements are used instead.

SHDN: Shutdown. Write this bit to logic 1 to force a shutdown of the device after timeout of the ShdnTimer register (default 45s delay). SHDN is reset to 0 at power-up and upon exiting shutdown mode. In order to command shutdown within 45 seconds, first write HibCFG = 0x0000 to enter active mode.

COMMSH: Communication Shutdown. Set to logic 1 to force the device to enter shutdown mode if both SDA and SCL are held low for more than timeout of the ShdnTimer register. This also configures the device to wake up on a rising edge of any communication. Note that if COMMSH and THSH are both set to 0, the device wakes up on any edge of SDA. Refer to the [User Guide 6597: MAX1726x ModelGauge m5 EZ User Guide](#) for details.

ETHRM: Enable Thermistor. Set to logic 1 to enable the TH pin measurement.

FTHRM: Force Thermistor Bias Switch. This allows the host to control the bias of the thermistor switch or enable fast detection of battery removal. Set FTHRM = 1 to always enable the thermistor bias switch. With a standard 10kΩ thermistor, this adds an additional ~200µA to the current drain of the circuit.

Aen: Enable alert on fuel-gauge outputs. When Aen = 1, any violation of the alert threshold register values by temperature, voltage, current, or SOC triggers an alert. This bit affects the ALRT pin operation only. The Smx, Smn, Tmx, Tmn, Vmx, Vmn, Imx, and Imn bits of the Status register (000h) are not disabled.

Bei: Enable alert on battery insertion when the IC is mounted host-side. When Bei = 1, a battery-insertion condition, as detected by the TH pin voltage, triggers an alert.

Ber: Enable alert on battery removal when the IC is mounted host-side. When Ber = 1, a battery-removal condition, as detected by the TH pin voltage, triggers an alert.

AtRateEn: AtRate enable. When this bit is set to 0, AtRate calculations are disabled and registers AtQResidual/AtTTE/AtAvSOC/AtAvCap can be used as general purpose memory.

DPEn: Dynamic power enable. When this bit is set to 0, Dynamic Power calculations are disabled and registers MaxPeakPower/SusPeakPower/MPPCurrent/SPPCurrent can be used as general purpose memory.

POWR: Sets the time constant for the AvgPower register. The default POR value of 0100b gives a time constant of

11.25s. The equation setting the period is:

AvgPower time constant = $45s \times 2^{(POWR-6)}$

dSOCen: SOC Change Alert Enable. Set this bit to 1 to enable alert output with the Status.dSOCi bit function. Write this bit to 0 to disable alert output with the Status.dSOCi bit. This bit is set to 0 at power-up.

TAIrten: Temperature Alert Enable. Set this bit to 1 to enable temperature based alerts. Write this bit to 0 to disable temperature alerts. This bit is set to 1 at power-up.

LDMdl: Host sets this bit to 1 in order to initiate firmware to finish processing a newly loaded model. Firmware clears this bit to zero to indicate that model loading is finished.

DRCfg: Deep relax time configuration. 00 for 0.8 to 1.6 hours, 01 for 1.6 to 3.2 hours, 10 for 3.2 to 6.4 hours and 11 for 6.4 to 12.8 hours.

CPMode: Constant-power mode. Set to 1 to enable constant-power mode. If it is set to 0, $AtRate/AvgCurrent$ is used for $(At)TTE/(At)QResidual/(At)AvSOC/(At)AvCap$. If it is set to 1, $AtRate/AvgCurrent \times \frac{AvgVCell}{(AvgVCell + VEmpty) / 2}$ is used for those calculations

ModelGauge m5 Algorithm

Classical coulomb-counter-based fuel gauges have excellent linearity and short-term performance. However, they suffer from drift due to the accumulation of the offset error in the current-sense measurement. Although the offset error is often very small, it cannot be eliminated. It causes the reported capacity error to increase over time and requires periodic corrections. Corrections are traditionally performed at full or empty. Some other systems also use the relaxed battery voltage to perform corrections. These systems determine the true state-of-charge (SOC) based on the battery voltage after a long time of no current flow. Both have the same limitation: if the correction condition is not observed over time in the actual application, the error in the system is boundless. The performance of classic coulomb counters is dominated by the accuracy of such corrections. Voltage measurement based SOC estimation has accuracy limitations due to imperfect cell modeling, but does not accumulate offset error over time.

The IC includes an advanced voltage fuel gauge (VFG) that estimates open-circuit voltage (OCV), even during current flow, and simulates the nonlinear internal dynamics of a Li+ battery to determine the SOC with improved accuracy. The model considers the time effects of a battery caused by the chemical reactions and impedance in the battery to determine SOC. This SOC estimation does not accumulate offset error over time. The IC performs a smart empty compensation algorithm that automatically compensates for the effect of temperature condition and load condition to provide accurate state-of-charge information. The converge-to-empty function eliminates error toward empty state. The IC learns battery capacity over time automatically to improve long-term performance. The age information of the battery is available in the output registers.

The ModelGauge m5 algorithm combines a high-accuracy coulomb counter with a VFG. See [Figure 2](#). The complementary combined result eliminates the weaknesses of both the coulomb counter and the VFG while providing the strengths of both. A mixing algorithm weighs and combines the VFG capacity with the coulomb counter and weighs each result so that both are used optimally to determine the battery state. In this way, the VFG capacity result is used to continuously make small adjustments to the battery state, cancelling the coulomb-counter drift.

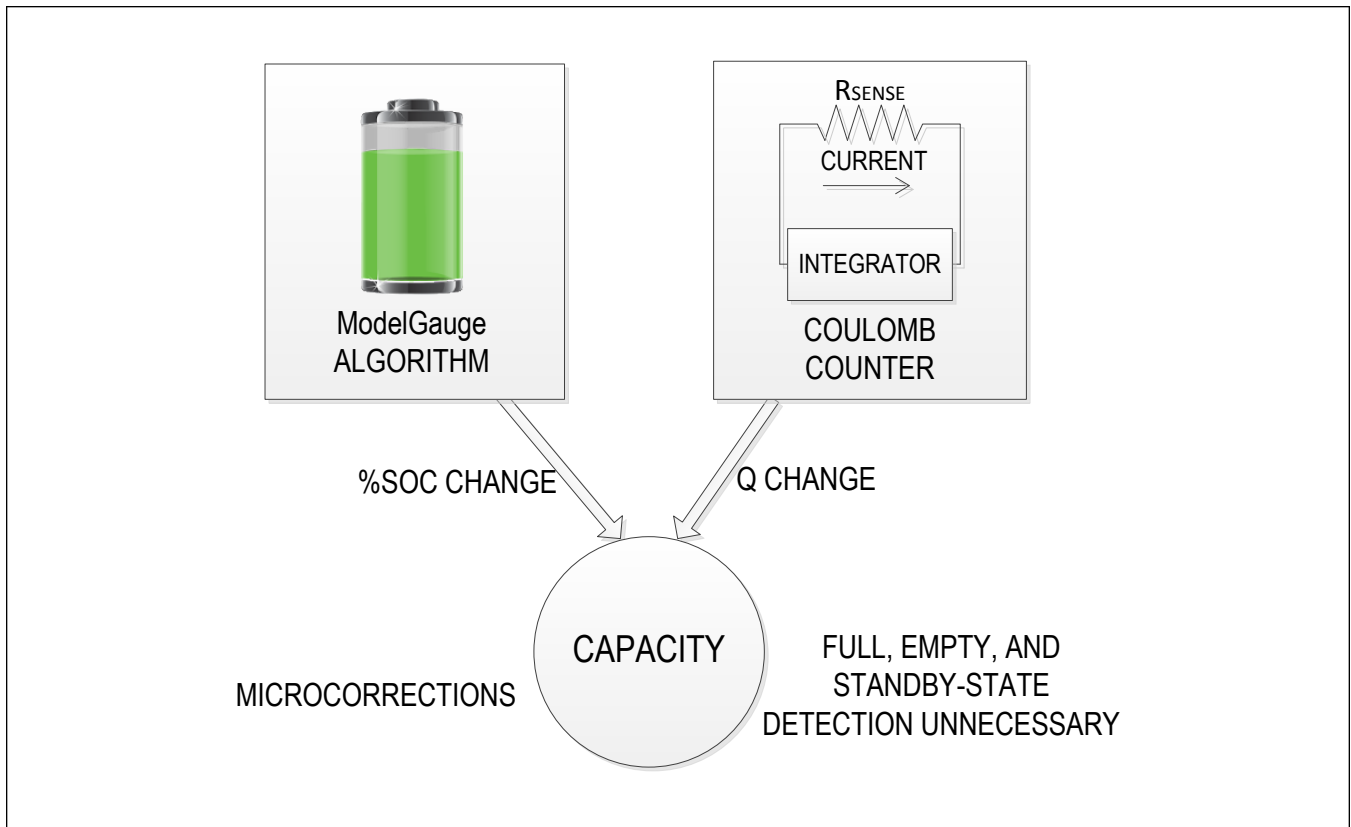

Figure 2. ModelGauge m5 Algorithm

The ModelGauge m5 algorithm uses this battery state information and accounts for temperature, battery current, age, and application parameters to determine the remaining capacity available to the system. As the battery approaches the critical region near empty, the ModelGauge m5 algorithm invokes a special error correction mechanism that eliminates any error.

The ModelGauge m5 algorithm continually adapts to the cell and application through independent learning routines. As the cell ages, its change in capacity is monitored and updated and the voltage-fuel-gauge dynamics adapt based on cell-voltage behavior in the application.

ModelGauge m5 Algorithm Output Registers

The following registers are outputs from the ModelGauge m5 algorithm. The values in these registers become valid 351ms after the IC is configured.

RepCap Register (05h)

Register Type: Capacity

RepCap or reported remaining capacity in mAh. The ModelGauge m5 algorithm prevents remaining capacity from making a sudden jump during load change conditions.

RepSOC Register (06h)

Register Type: Percentage

RepSOC is the reported state-of-charge percentage output for use by the application user interface.

FullCapRep Register (10h)

Register Type: Capacity

This register reports the full capacity that goes with RepCap, generally used for reporting to the user. A new full-capacity value is calculated at the end of every charge cycle in the application.

TTE Register (11h)

Register Type: Time

The TTE register holds the estimated time to empty for the application under present temperature and load conditions. TTE register is only valid when current register is negative.

TTF Register (20h)

Register Type: Time

The TTF register holds the estimated time to full for the application under present conditions. The TTF value is determined by learning the constant current and constant voltage portions of the charge cycle based on experience of prior charge cycles. Time-to-full is then estimated by comparing the present charge current to the charge termination current. Operation of the TTF register assumes all charge profiles are consistent in the application. The TTF register is only valid when the current register is positive.

Cycles Register (17h)

Register Type: Special

The Cycles register maintains a total count of the number of charge/discharge cycles of the cell. The result is stored as a fraction of a full cycle. For example, a full charge/discharge cycle results in the Cycles register incrementing by 100%. The Cycles register accumulates fractional or whole cycles. For example, if a battery is cycled 10% x 10 times, then it is equivalent to 100% of one cycle. The Cycles register has a full range of 0 to 655.35 cycles with a 1% LSb.

Status Register (00h)

Register Type: Special

Initial Value: 0x8082

The Status register maintains all flags related to alert thresholds and battery insertion or removal. [Table 7](#) shows the Status register format.**Table 7. Status (00h) Format**

| D15 | D14 | D13 | D12 | D11 | D10 | D9 | D8 | D7 | D6 | D5 | D4 | D3 | D2 | D1 | D0 |
|-----|-----|-----|-----|-----|-----|-----|-----|-------|-----|----|----|-----|-----|-----|----|
| Br | Smx | Tmx | Vmx | Bi | Smn | Tmn | Vmn | dSOCi | Imx | X | X | Bst | Imn | POR | X |

POR (Power-On Reset): This bit is set to 1 when the device detects that a software or hardware POR event has occurred. This bit must be cleared by system software to detect the next POR event. POR is set to 1 at power-up.**Imn and Imx (Minimum/Maximum Current-Alert Threshold Exceeded):** These bits are set to 1 whenever a Current register reading is below (Imn) or above (Imx) the IAlrtTh thresholds. These bits may or may not need to be cleared by system software to detect the next event. See Config.IS bit description. Imn and Imx are cleared to 0 at power-up.

Vmn and Vmx (Minimum/Maximum Voltage-Alert Threshold Exceeded): These bits are set to 1 whenever a VCell register reading is below (Vmn) or above (Vmx) the VAlrtTh thresholds. These bits may or may not need to be cleared by system software to detect the next event. See Config.VS bit description. Vmn and Vmx are cleared to 0 at power-up.

Tmn and Tmx (Minimum/Maximum Temperature-Alert Threshold Exceeded): These bits are set to 1 whenever a Temperature register reading is below (Tmn) or above (Tmx) the TAlrtTh thresholds. These bits may or may not need to be cleared by system software to detect the next event. See Config.TS bit description. Tmn and Tmx are cleared to 0 at power-up.

Smn and Smx (Minimum/Maximum SOC-Alert Threshold Exceeded): These bits are set to 1 whenever SOC is below (Smn) or above (Smx) the SAlrtTh thresholds. These bits may or may not need to be cleared by system software to detect the next event. See Config.SS description. Smn and Smx are cleared to 0 at power-up.

Bst (Battery Status): Useful when the IC is used in a host-side application. This bit is set to 0 when a battery is present in the system, and set to 1 when the battery is absent. Bst is set to 0 at power-up.

dSOCi (State-of-Charge 1% Change Alert): This is set to 1 whenever the RepSOC register crosses an integer percentage boundary such as 50.0%, 51.0%, etc. Must be cleared by host software. dSOCi is set to 1 at power-up.

Bi (Battery Insertion): Useful when the IC is used in a host-side application. This bit is set to 1 when the device detects that a battery has been inserted into the system by monitoring the TH pin. This bit must be cleared by system software to detect the next insertion event. Bi is set to 0 at power-up.

Br (Battery Removal): Useful when the IC is used in a host-side application. This bit is set to 1 when the system detects that a battery has been removed from the system. This bit must be cleared by system software to detect the next removal event. Br is set to 1 at power-up.

X (Don't Care): This bit is undefined and can be logic 0 or 1.

Analog Measurements

The IC monitors voltage, current, and temperature. This information is provided to the fuel-gauge algorithm to predict cell capacity and also made available to the user.

Voltage Measurement

VCell Register (09h)

Register Type: Voltage

VCell reports the voltage measured between BATT and GND.

AvgVCell Register (19h)

Register Type: Voltage

The AvgVCell register reports an average of the VCell register readings.

MaxMinVolt Register (1Bh)

Register Type: Special

Initial Value: 0x00FF

The MaxMinVolt register maintains the maximum and minimum of VCell register values since device reset. At power-up, the maximum voltage value is set to 00h (the minimum) and the minimum voltage value is set to FFh (the maximum). Therefore, both values are changed to the voltage register reading after the first update. Host software can reset this register by writing it to its power-up value of 0x00FF. The maximum and minimum voltages are each stored as 8-bit values with a 20mV resolution. [Table 8](#) shows the register format.

Table 8. MaxMinVolt (1Bh) Format

| D15 | D14 | D13 | D12 | D11 | D10 | D9 | D8 | D7 | D6 | D5 | D4 | D3 | D2 | D1 | D0 |
|----------|-----|-----|-----|-----|-----|----|----|----------|----|----|----|----|----|----|----|
| MaxVCELL | | | | | | | | MinVCELL | | | | | | | |

MaxVCELL: Maximum VCell register reading

MinVCELL: Minimum VCell register reading

Current Measurement

The MAX17262 monitors the current flow through the battery by measuring the voltage across the internal current sensing element. The IC is precalibrated for current-measurement accuracy in Maxim's factory. Additionally, the IC maintains a record of the minimum and maximum current measured by the IC and an average current.

The maximum current constraints listed in the [Absolute Maximum Ratings](#) section should be followed to ensure the 100,000 hours lifetime of the sensing element. In general, the root mean square of current over whole lifetime should be below 1.7A, with additional limitation on peak value based on utilization. If the device utilization is 100% (charges or discharges at highest allowable current level without stopping), then the maximum DC current rating is 1.7A. If the device utilization is 10%, then the maximum DC current allowed is 2.4A. For example, it spends 10% of its time charging, and the remaining 90% resting or discharging, then it can be allowed 2.4A charge current, but discharge currents should be below 1.6A. For Pulse current case, if the utilization of the current pulse is 1% of whole lifetime, then the peak pulse current allowed with 250ms pulse width and 10% duty cycle is 3.1A. The utilization patterns are visualized in [Figure 3](#).

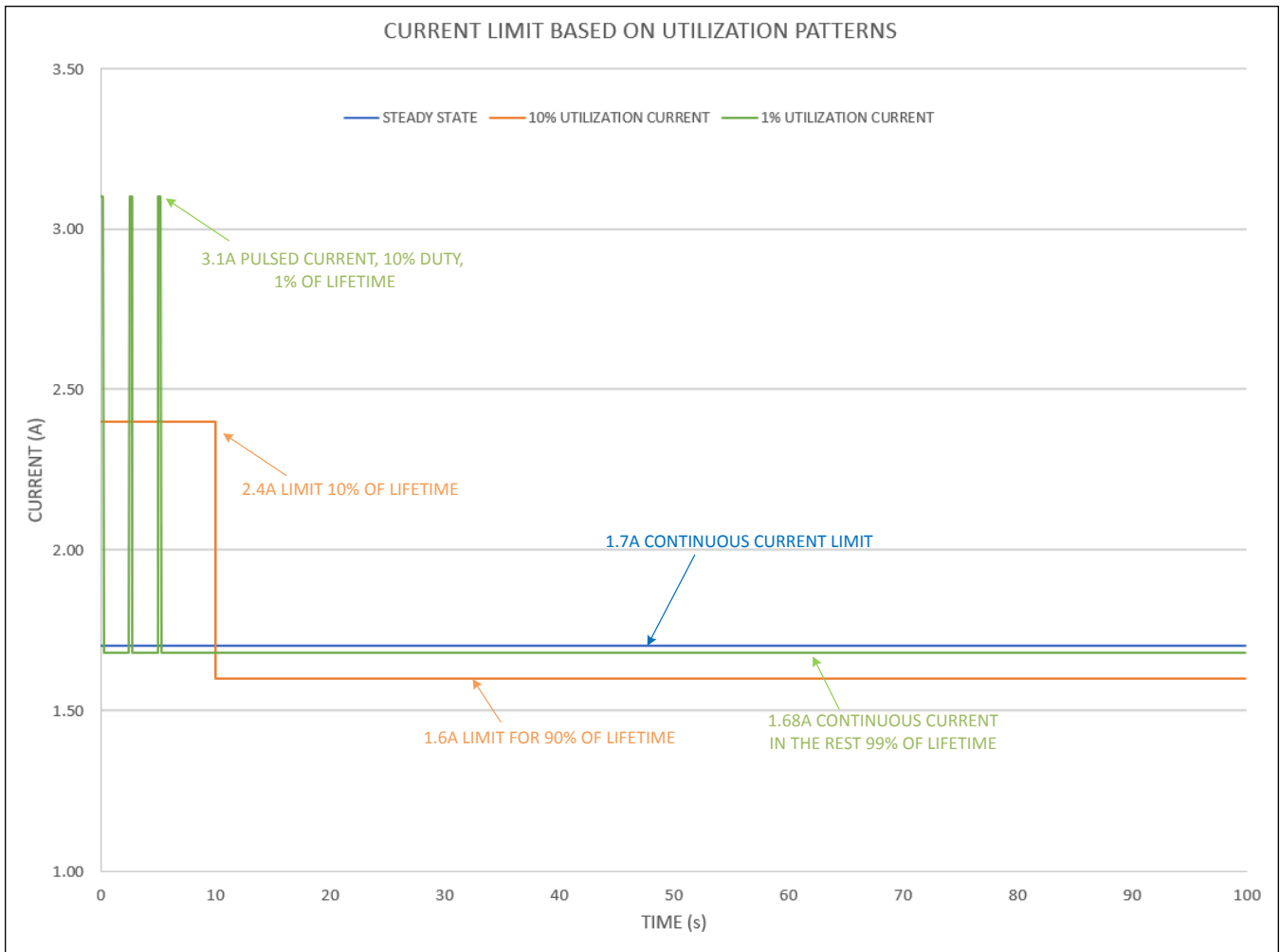

Figure 3. Current Limit Based On Utilization Patterns

Current Register (0Ah)

Register Type: Current

The MAX17262 uses internal current sensing to monitor the current through the SYS pin. The measurement value is stored in two's-complement format. Measurement that exceeds maximum and minimum current range is stored as maximum and minimum value. The current register has a LSB value of 156.25µA, a register scale range of ± 5.12 A, and an allowable measurement range as described in the [Absolute Maximum Ratings](#).

AvgCurrent Register (0Bh)

Register Type: Current

The AvgCurrent register reports an average of Current register readings.

MaxMinCurr Register (1Ch)

Register Type: Special

Initial Value: 0x807F

The MaxMinCurr register maintains the maximum and minimum Current register values since the last IC reset or until cleared by host software. At power-up, the maximum current value is set to 80h (most negative) and the minimum current value is set to 7Fh (most positive). Therefore, both values are changed to the Current register reading after the first update. Host software can reset this register by writing it to its power-up value of 0x807F. The maximum and minimum currents are each stored as two's complement 8-bit values with 160mA resolution. [Table 9](#) shows the register format.

Table 9. MaxMinCurr (1Ch) Format

| D15 | D14 | D13 | D12 | D11 | D10 | D9 | D8 | D7 | D6 | D5 | D4 | D3 | D2 | D1 | D0 |
|------------|-----|-----|-----|-----|-----|----|----|------------|----|----|----|----|----|----|----|
| MaxCurrent | | | | | | | | MinCurrent | | | | | | | |

MaxCurrent: Maximum Current register reading

MinCurrent: Minimum Current register reading

Temperature Measurement

The IC can be configured to measure its own internal die temperature or an external NTC thermistor.

Set Config.TSEL = 0 (default) to enable die temperature measurement. Set Config.TSEL = 1 to enable thermistor measurement.

Thermistor conversions are initiated by periodically connecting the TH and BATT pins internally. Measurement results of TH pin are compared to the voltage of the BATT pin and converted to a ratiometric value from 0% to 100%. The active pullup is disabled when temperature measurements are complete. This reduces the current consumption.

The ratiometric results are converted to temperature using the temperature gain (TGain), temperature offset (TOff), and temperature curve (Curve) register values. Internal die temperature measurements are factory calibrated and are not affected by TGain, TOff, and Curve register settings. Refer to the [User Guide 6597: MAX1726x ModelGauge m5 EZ User Guide](#) for more details. Additionally, the IC maintains a record of the minimum and maximum temperature measured and an average temperature.

Temp Register (08h)

Register Type: Temperature

The Temp register provides the temperature measured by the thermistor or die temperature based on the Config register setting.

AvgTA Register (16h)

Register Type: Temperature

The AvgTA register reports an average of the readings from the Temp register.

MaxMinTemp Register (1Ah)

Register Type: Special

Initial Value: 0x807F

The MaxMinTemp register maintains the maximum and minimum Temp register (08h) values since the last fuel-gauge reset or until cleared by host software. At power-up, the maximum value is set to 0x80 (most negative) and the minimum value is set to 0x7F (most positive). Therefore, both values are changed to the Temp register reading after the first update. Host software can reset this register by writing it to its power-up value of 0x807F. The maximum and minimum temperatures are each stored as two's complement 8-bit values with 1°C resolution. [Table 10](#) shows the format of the register.

Table 10. MaxMinTemp (1Ah) Format

| D15 | D14 | D13 | D12 | D11 | D10 | D9 | D8 | D7 | D6 | D5 | D4 | D3 | D2 | D1 | D0 |
|----------------|-----|-----|-----|-----|-----|----|----|----------------|----|----|----|----|----|----|----|
| MaxTemperature | | | | | | | | MinTemperature | | | | | | | |

MaxTemperature: Maximum Temp register reading

MinTemperature: Minimum Temp register reading

DieTemp Register (034h)

Register Type: Temperature

The DieTemp register provides the internal die temperature measurement. If Config.TSel = 0, DieTemp and Temp registers have the value of the die temperature.

Power Register (B1h)

Instant power calculation from immediate current and voltage. The LSB is 1.6mW.

AvgPower Register (B3h)

Filtered average power from the Power register. LSB is 1.6mW.

Alert Function

The Alert Threshold registers allow interrupts to be generated by detecting a high or low voltage, current, temperature, or state-of-charge. Interrupts are generated on the ALRT pin open-drain output driver. An external pullup is required to generate a logic-high signal. Alerts can be triggered by any of the following conditions:

- Battery removal: ($V_{TH} > V_{BATT} - V_{DET}$) and battery removal detection enabled (Ber = 1).
- Battery insertion: ($V_{TH} < V_{BATT} - V_{DET-HYS}$) and battery insertion detection enabled (Bei = 1).
- Over/undervoltage: VAlrtTr register threshold violation (upper or lower) and alerts enabled (Aen = 1).
- Over/undertemperature: TAlrtTr register threshold violation (upper or lower) and alerts enabled (Aen = 1).
- Over/undercurrent: IAlrtTr register threshold violation (upper or lower) and alerts enabled (Aen = 1).
- Over/under SOC: SAlrtTr register threshold violation (upper or lower) and alerts enabled (Aen = 1).
- 1% SOC change: RepSOC register bit d8 (1% bit) changed (dSOCen = 1).

To prevent false interrupts, the threshold registers should be initialized before setting the Aen bit. Alerts generated by battery insertion or removal can only be reset by clearing the corresponding bit in the Status (00h) register. Alerts generated by a threshold-level violation can be configured to be cleared only by software, or cleared automatically when the threshold level is no longer violated. See the Config (1Dh) and Config2 (BBh) register descriptions for details of the alert function configuration.

VAlrtTh Register (01h)

Register Type: Special

Initial Value: 0xFF00 (Disabled)

The VAlrtTh register shown in [Table 11](#) sets upper and lower limits that generate an alert if exceeded by the VCell register value. The upper 8 bits set the maximum value and the lower 8 bits set the minimum value. Interrupt threshold limits are selectable with 20mV resolution over the full operating range of the VCell register.

Table 11. VAlrtTh (01h) Format

| D15 | D14 | D13 | D12 | D11 | D10 | D9 | D8 | D7 | D6 | D5 | D4 | D3 | D2 | D1 | D0 |
|------|-----|-----|-----|-----|-----|----|----|------|----|----|----|----|----|----|----|
| VMAX | | | | | | | | VMIN | | | | | | | |

VMAX: Maximum voltage reading. An alert is generated if the VCell register reading exceeds this value.

VMIN: Minimum voltage reading. An alert is generated if the VCell register reading falls below this value.

TAIrtTh Register (02h)

Register Type: Special

Initial Value: 0x7F80 (Disabled)

The TAIrtTh register ([Table 12](#)) sets upper and lower limits that generate an alert if exceeded by the Temp register value. The upper 8 bits set the maximum value and the lower 8 bits set the minimum value. Interrupt threshold limits are stored in two's-complement format with 1°C resolution over the full operating range of the Temp register.

Table 12. TAIrtTh (02h) Format

| D15 | D14 | D13 | D12 | D11 | D10 | D9 | D8 | D7 | D6 | D5 | D4 | D3 | D2 | D1 | D0 |
|------|-----|-----|-----|-----|-----|----|----|------|----|----|----|----|----|----|----|
| TMAX | | | | | | | | TMIN | | | | | | | |

TMAX: Maximum temperature reading. An alert is generated if the Temp register reading exceeds this value.

TMIN: Minimum temperature reading. An alert is generated if the Temp register reading falls below this value.

SAIrtTh Register (03h)

Register Type: Special

Initial Value: 0xFF00 (Disabled)

The SAIrtTh register shown ([Table 13](#)) sets upper and lower limits that generate an alert if exceeded by RepSOC. The upper 8 bits set the maximum value and the lower 8 bits set the minimum value. Interrupt threshold limits are configurable with 1% resolution over the full operating range of the RepSOC register.

Table 13. SAIrtTh (03h) Format

| D15 | D14 | D13 | D12 | D11 | D10 | D9 | D8 | D7 | D6 | D5 | D4 | D3 | D2 | D1 | D0 |
|------|-----|-----|-----|-----|-----|----|----|------|----|----|----|----|----|----|----|
| SMAX | | | | | | | | SMIN | | | | | | | |

SMAX: Maximum state-of-charge threshold. An alert is generated if the RepSOC register exceeds this value.

SMIN: Minimum state-of-charge threshold. An alert is generated if the RepSOC register falls below this value.

IAIrtTh Register (B4h)

Register Type: Special

Initial Value: 0x7F80 (Disabled)

The IAIrtTh register ([Table 14](#)) sets upper and lower limits that generate an alert if exceeded by the Current register value. The upper 8 bits set the maximum value and the lower 8 bits set the minimum value. Interrupt threshold limits are selectable with 80mA resolution over the full operating range of the Current register.

Table 14. IAirtTh (B4h) Format

| | | | | | | | | | | | | | | | |
|------|-----|-----|-----|-----|-----|----|----|------|----|----|----|----|----|----|----|
| D15 | D14 | D13 | D12 | D11 | D10 | D9 | D8 | D7 | D6 | D5 | D4 | D3 | D2 | D1 | D0 |
| IMAX | | | | | | | | IMIN | | | | | | | |

IMAX: Maximum current reading. An alert is generated if the current register reading exceeds this value.

IMIN: Maximum current reading. An alert is generated if the current register reading falls below this value.

Serial Number Feature

Each IC provides a unique serial number ID. To read this serial number, clear the AtRateEn and the DPEn bit in the Config2 register. The 128-bit serial information overwrites the Dynamic Power and AtRate output registers. To continue Dynamic Power and AtRate operations after reading the serial number, the host should set Config2.AtRateEn and Config2.DPEn to 1.

Table 15. Serial Number Format

| ADDRESS | Config2.AtRateEn = 1 Config2.DPEn = 1 | Config2.AtRateEn = 0 && Config2.DPEn = 0 |
|---------|--|--|
| 0xD4 | MaxPeakPower | Serial Number Word0 |
| 0xD5 | SusPeakPower | Serial Number Word1 |
| 0xD9 | MPPCurrent | Serial Number Word2 |
| 0xDA | SPPCurrent | Serial Number Word3 |
| 0xDC | AtQResidual | Serial Number Word4 |
| 0xDD | AtTTE | Serial Number Word5 |
| 0xDE | AtAvSoc | Serial Number Word6 |
| 0xDF | AtAvCap | Serial Number Word7 |

ModelGauge m5 Memory Space

Registers that relate to functionality of the ModelGauge m5 fuel gauge are located on pages 0h-4h and are continued on pages Bh and Dh. See the [ModelGauge m5 EZ Algorithm](#) section for details of specific register operation. Register locations marked reserved should not be written to.

Table 16. ModelGauge m5 Register Memory Map

| PAGE/ WORD | 00h | 10h | 20h | 30h | 40h | B0h | D0h |
|---------------|---------|------------|------------|-----------|-----------|------------------|----------------------|
| 0h | Status | FullCapRep | TTF | Reserved | Reserved | Status2 | RSense / UserMem3 |
| 1h | VAirtTh | TTE | DevName | Reserved | Reserved | Power | ScOcvLim |
| 2h | TAirtTh | QRTable00 | QRTable10 | QRTable20 | QRTable30 | ID / UserMem2 | VGain |
| 3h | SAirtTh | FullSocThr | FullCapNom | Reserved | RGain | AvgPower | SOCHold |
| 4h | AtRate | RCell | Reserved | DieTemp | Reserved | IAirtTh | MaxPeakPower |

Table 16. ModelGauge m5 Register Memory Map (continued)

| PAGE/ WORD | 00h | 10h | 20h | 30h | 40h | B0h | D0h |
|---------------|------------|------------|-----------|-----------|----------|------------|----------------|
| 5h | RepCap | Reserved | Reserved | FullCap | dQAcc | TTFCfg | SusPeakPower |
| 6h | RepSOC | AvgTA | Reserved | Reserved | dPAcc | CVMixCap | PackResistance |
| 7h | Age | Cycles | AIN | Reserved | Reserved | CVHalfTime | SysResistance |
| 8h | Temp | DesignCap | LearnCfg | RComp0 | Reserved | CGTempCo | MinSysVoltage |
| 9h | VCell | AvgVCell | FilterCfg | TempCo | ConvgCfg | Curve | MPPCurrent |
| Ah | Current | MaxMinTemp | RelaxCfg | VEmpty | VFRemCap | HibCfg | SPPCurrent |
| Bh | AvgCurrent | MaxMinVolt | MiscCfg | Reserved | Reserved | Config2 | ModelCfg |
| Ch | QResidual | MaxMinCurr | TGain | Reserved | Reserved | VRipple | AtQResidual |
| Dh | MixSOC | Config | TOff | FStat | QH | RippleCfg | AtTTE |
| Eh | AvSOC | IChgTerm | CGain | Timer | Reserved | TimerH | AtAvSOC |
| Fh | MixCap | AvCap | COff | ShdnTimer | Reserved | Reserved | AtAvCap |

Layout Guidelines

Proper circuit layout as shown in [Figure 4](#) is essential for voltage, temperature, and current measurement accuracy. The recommended layout guidelines are as follows:

- REG capacitor trace loop area should be minimized. REG should be connected to the GND pin as close as possible to the IC. This helps filter any noise from the internal regulated supply.

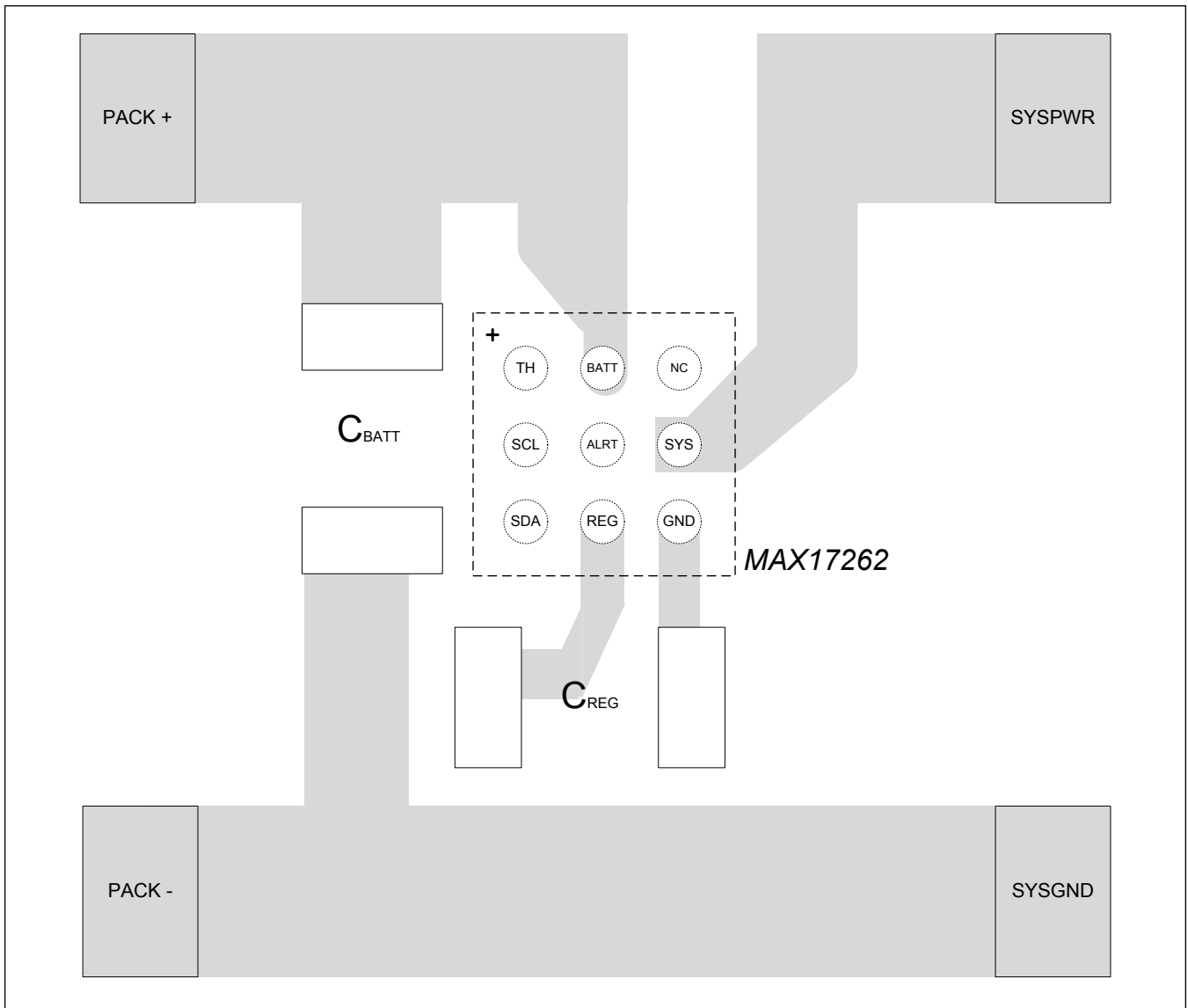

Figure 4. MAX17262 Layout Guide

MAX17262

5.2µA 1-Cell Fuel Gauge with ModelGauge m5 EZ
and Internal Current Sensing

Ordering Information

| PART NUMBER | TEMP RANGE | DESCRIPTION | PIN-PACKAGE |
|----------------|----------------|-------------------------------|-------------|
| MAX17262REWL+ | -40°C to +85°C | Single-Cell, Internal Sensing | 9-WLP |
| MAX17262REWL+T | -40°C to +85°C | Single-Cell, Internal Sensing | 9-WLP |

+Denotes a lead(Pb)-free/RoHS-compliant package.

T = Tape and reel.

MAX17262

5.2μA 1-Cell Fuel Gauge with ModelGauge m5 EZ
and Internal Current Sensing

Revision History

| REVISION NUMBER | REVISION DATE | DESCRIPTION | PAGES CHANGED |
|-----------------|---------------|-----------------|---------------|
| 0 | 7/18 | Initial release | — |

For pricing, delivery, and ordering information, please contact Maxim Direct at 1-888-629-4642, or visit Maxim Integrated's website at www.maximintegrated.com.

Maxim Integrated cannot assume responsibility for use of any circuitry other than circuitry entirely embodied in a Maxim Integrated product. No circuit patent licenses are implied. Maxim Integrated reserves the right to change the circuitry and specifications without notice at any time. The parametric values (min and max limits) shown in the Electrical Characteristics table are guaranteed. Other parametric values quoted in this data sheet are provided for guidance.