

# Thick Film High Power Low Ohm Chip Resistor

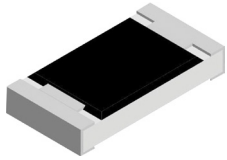

**RoHS  
Compliant**

## Description:



The resistors are constructed in a high grade ceramic body (aluminium oxide). Internal metal electrodes are added at each end and connected by a resistive paste that is applied to the top surface of the substrate. The composition of the paste is adjusted to give the approximate resistance required and the value is trimmed to within tolerance by laser cutting of this resistive layer.

The resistive layer is covered with a protective coat. Finally, the two external end terminations are added. For ease of soldering the outer layer of these end terminations is a Tin (lead free) alloy.

## Features:

- High power rating and compact size
- High reliability and stability
- Reduced size of final equipment
- Lead free products

## Application:

- Power supply
- PDA, Digital meter and Computer
- Automotive and Battery charger
- DC-DC power converter

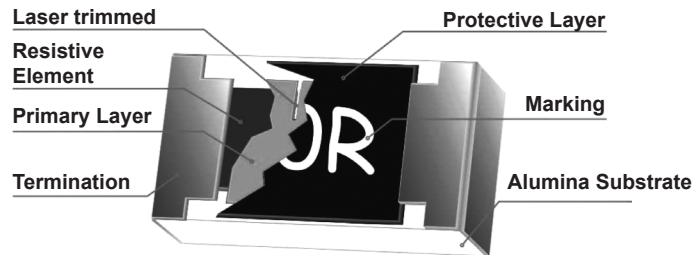

Construction of Chip-R

## Quick Reference Data

Item	General Specification		
Series No.	MCWW25P	MCWW20P	MCWW12P
Size code	2512 (6432)	2010 (5025)	1206 (3216)
Resistance Tolerance	±1%, ±5%		
Resistance Range	0.047Ω to 0.976Ω		0.020Ω ~ 0.976Ω
TCR (ppm/°C)	±100ppm		±100ppm
100mΩ to 976mΩ	±150ppm		±200ppm
47mΩ to 97.6mΩ	-		±1000ppm
20 mΩ to 43mΩ			
Max. Dissipation @ Tamb = 70°C	2 W	1 W	1/2 W
Max. Operation Voltage (DC or RMS)	300V	200V	200V
Max. Overload Voltage (DC or RMS)	500V	400V	400V
Climatic category (IEC 60068)	55/155/56		

## Note:

1. This is the maximum voltage that may be continuously supplied to the resistor element, see "IEC publication 60115-8"
2. Max. Operation Voltage : So called RCWV (Rated Continuous Working Voltage) is determined by  

$$RCWV = \sqrt{\text{Rated Power} \times \text{Resistance Value}}$$
 or Max. RCWV listed above, whichever is lower.
3. 2W loading with total solder-pad and trace size of 300mm<sup>2</sup>
4. Resistance value will be changed by soldering condition and design of soldering pad, please design products in consideration of this change of resistance value.

www.element14.com  
www.farnell.com  
www.newark.com



# Thick Film High Power Low Ohm Chip Resistor



## Mechanical Data

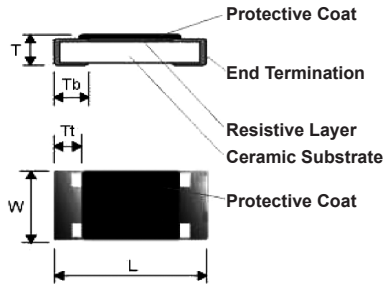

Part Number	MCWW25P	MCWW20P	MCWW12P
<b>L</b>	6.3 ±0.2	5 ±0.2	3.1 ±0.15
<b>W</b>	3.1 ±0.2	2.5 ±0.2	1.6 ±0.15
<b>T</b>	0.6 ±0.15	0.6 ±0.1	0.55 ±0.1
<b>Tt</b>	0.6 ±0.25	0.6 ±0.25	0.5 ±0.25
<b>Tb</b>	1.8 ±0.25	0.6 ±0.25	0.5 ±0.25

Dimensions : Millimetres

## Recommended Solder Pad Dimensions

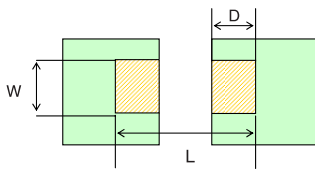

Type	W	D	L
MCWW25P	3.7mm	2.45mm	7.6mm

## Marking

Each resistor is marked with a four-digit code on the protective coating to designate the nominal resistance value.

### Example:

R100 = 0.1Ω  
R910 = 0.91Ω

## Functional Description:

### Product characterization

Standard values of nominal resistance are taken from the E96 & E24 series for resistors with a tolerance of ±5% & ±1%. The values of the E24/E96 series are in accordance with "IEC publication 60063".

### Derating

The power that the resistor can dissipate depends on the operating temperature.

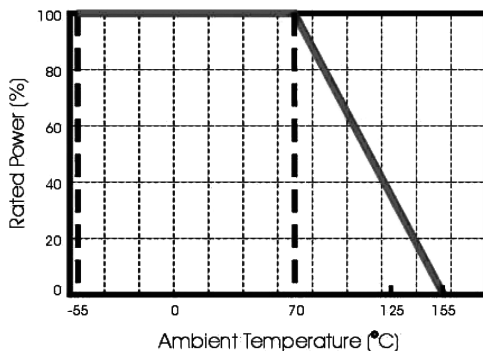

**Max. Dissipation in percentage of rated power  
As a function of the ambient temperature**



# Thick Film High Power Low Ohm Chip Resistor



## Mounting

Due to their rectangular shapes and small tolerances, Surface Mountable Resistors are suitable for handling by automatic placement systems.

Chip placement can be on ceramic substrates and printed-circuit boards (PCBs).

Electrical connection to the circuit is by individual soldering condition.

The end terminations guarantee a reliable contact.

## Soldering Condition:

The robust construction of chip resistors allows them to be completely immersed in a solder bath of 260°C for 10 seconds. Therefore, it is possible to mount Surface Mount Resistors on one side of a PCB and other discrete components on the reverse (mixed PCBs).

Surface Mount Resistors are tested for solderability at 235°C during 2 seconds. The test condition for no leaching is 260°C for 30 seconds. Typical examples of soldering processes that provide reliable joints without any damage are given in below figure.

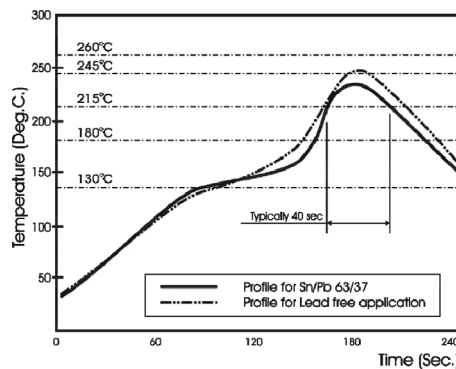

Infrared soldering profile for Chip Resistor

## Catalogue Numbers:

The resistors have a catalogue number starting with

MCWW25	X	P	R100	J	T	L
<b>Size code</b> MCWW25 : 2512 MCWW20 : 2010 MCWW12 : 1206	<b>Type code</b> X : Normal	<b>Type code</b> P :Power 2512 size = 2 watt 2010 size = 1 watt 1206 size = 0.5 watt	<b>Resistance code</b> E96 +E24: "R" is first digit followed by 3 significant digits. e.g: 0.1Ω = R100 0.047Ω = R047 0.56Ω = R560	<b>Tolerance</b> J : ±5% F : ±1%	<b>Packaging code</b> T : 7" Reel taping G : 13" Reel taping	<b>Termination code</b> L = Sn base (lead free)

Tape packaging MCWW12 : 8mm width paper taping 5,000pcs per 7" reel. 20,000pcs per 13" reel.  
MCWW25 & MCWW20 : 12mm width plastic taping 4,000pcs per reel.



# Thick Film High Power Low Ohm Chip Resistor



## Test And Requirements

Basic specification : JIS C 5201-1 : 1998

Test	Procedure	Requirement
<b>Clause 4.8</b> Temperature Coefficient of Resistance (TCR )	Natural resistance change per change in degree Centigrade. $\frac{R_2 - R_1}{R_1(t_2 - t_1)} \times 10^6 \quad (\text{ppm}/^\circ\text{C})$ R1 : Resistance at reference temperature R2 : Resistance at test temperature t1 : 20°C +5°C -1°C.	Refer to quick reference data for T.C.R specification
<b>Clause 4.13</b> Short time overload	Permanent resistance change after 5 second application of a power 5.0 times of rated power or the maximum overload voltage specified in the above list, whichever is less.	$\Delta R/R$ max. J : $\leq \pm(2\% + 0.5\text{m}\Omega)$ F : $\leq \pm(1\% + 0.5\text{m}\Omega)$
<b>Clause 4.18</b> Resistance to soldering heat (R.S.H)	Un-mounted chips completely immersed for 10±1second in a SAC solder bath at 260°C ±5°C.	No visible damage $\Delta R/R$ max. J : $\leq \pm(1\% + 0.5\text{m}\Omega)$ F : $\leq \pm(0.5\% + 0.5\text{m}\Omega)$
<b>Clause 4.17</b> Solderability	Un-mounted chips completely immersed for 2 ±0.5 second in a SAC solder bath at 235°C ±5°C.	Good tinning (>95% covered) No visible damage
<b>Clause 4.19</b> Temperature cycling	1. 30 minutes at -55°C ±3°C, 2. 2~3 minutes at 20°C +5°C-1°C, 3. 30 minutes at +155° ±3°C, 4. 2~3 minutes at 20°C +5°C-1°C, Total 5 continuous cycles.	No visible damage $\Delta R/R$ max. J : $\leq \pm(1\% + 1\text{m}\Omega)$ F : $\leq \pm(0.5\% + 1\text{m}\Omega)$
<b>Clause 4.25</b> Load life (endurance)	1000 +48/-0 hours, loaded with RCWV or Vmax in chamber controller 70±2°C, 1.5 hours on and 0.5 hours off.	No visible damage $\Delta R/R$ max. J : $\leq \pm(3\% + 0.5\text{m}\Omega)$ F : $\leq \pm(1\% + 0.5\text{m}\Omega)$
<b>Clause 4.24</b> Load life in Humidity	1000 +48/-0 hours, loaded with RCWV or Vmax in humidity chamber controller at 40°C±2°C and 90~95% relative humidity, 1.5 hours on and 0.5 hours off.	No visible damage $\Delta R/R$ max. J : $\leq \pm(3\% + 0.5\text{m}\Omega)$ F : $\leq \pm(1\% + 0.5\text{m}\Omega)$
<b>Clause 4.33</b> Bending strength	Resistors mounted on a 90mm glass epoxy resin PCB(FR4); bending : 2 mm(2512;2010) 3mm(1206), once for 10 seconds	No visible damage $\Delta R/R$ max. J : $\leq \pm(1\% + 1\text{m}\Omega)$ F : $\leq \pm(0.5\% + 1\text{m}\Omega)$
<b>Clause 4.32</b> Adhesion	Pressurizing force: 5N, Test time: 10±1sec.	No remarkable damage or removal of the terminations
<b>Clause 4.6</b> Insulation Resistance	Apply the maximum overload voltage (DC) for 1minute	R ≥1GΩ
<b>Clause 4.7</b> Dielectric Withstand Voltage	Apply the maximum overload voltage (AC) for 1 minute	No breakdown or flashover

# Thick Film High Power Low Ohm Chip Resistor



## Packaging:

Paper Tape(MCWW12P) & Plastic Tape(MCWW25P; MCWW20P) specifications

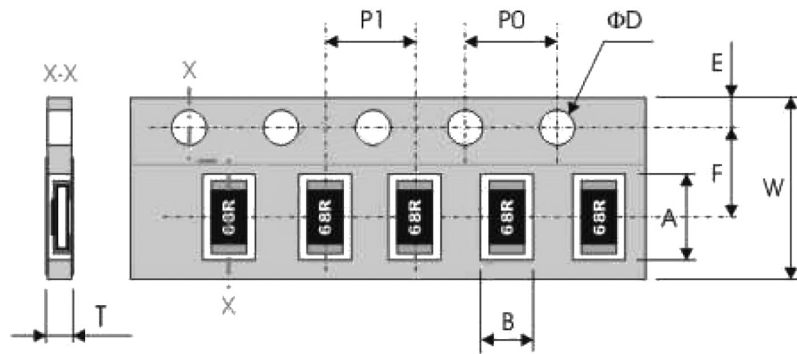

Series No.	A	B	W	F	E	P1	P0	D	T
MCWW25P	6.9 ±0.2	3.6 ±0.2	12 ±0.3	5.5 ±0.1	1.75 ±0.1	4 ±0.1	4 ±0.1	1.5 <sup>+0.1</sup> <sub>-0</sub>	Max. 1.2
MCWW20P	5.5 ±0.2	2.8 ±0.2							
MCWW12P	3.6 ±0.2	2 ±0.20	8 ±0.3	3.5 ±0.2					Max. 1

Dimensions : Millimetres

## Reel dimensions:

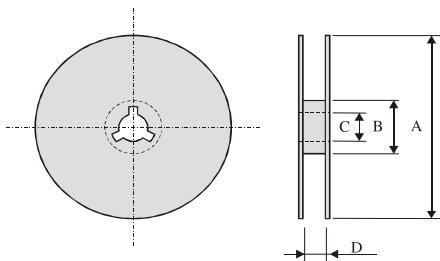

Reel / Tape	A	B	C	D
7" reel for 8mm tape	Φ178 ±2	Φ60 ±1	13 ±0.2	9 ±0.5
7" reel for 12mm tape				12.4 ±1
13" reel for 8mm tape	Φ330 ±2	Φ100 ±1		9 ±0.5

Dimensions : Millimetres

**Important Notice :** This data sheet and its contents (the "Information") belong to the members of the Premier Farnell group of companies (the "Group") or are licensed to it. No licence is granted for the use of it other than for information purposes in connection with the products to which it relates. No licence of any intellectual property rights is granted. The Information is subject to change without notice and replaces all data sheets previously supplied. The Information supplied is believed to be accurate but the Group assumes no responsibility for its accuracy or completeness, any error in or omission from it or for any use made of it. Users of this data sheet should check for themselves the Information and the suitability of the products for their purpose and not make any assumptions based on information included or omitted. Liability for loss or damage resulting from any reliance on the Information or use of it (including liability resulting from negligence or where the Group was aware of the possibility of such loss or damage arising) is excluded. This will not operate to limit or restrict the Group's liability for death or personal injury resulting from its negligence. Multicomp is the registered trademark of the Group. © Premier Farnell Limited 2016.

www.element14.com  
www.farnell.com  
www.newark.com

