

885 Series Fuse



Description



The 885 Nano²® Surface Mount Fuses are high voltage rated fuses with high interrupting current ratings at 450VDC/500VDC and 350VAC. It complies with IEC 60127-7 Standard.

Features

- Heat resistant plastic body, UL 94 V-0
- Meets Littelfuse's Automotive qualifications*
- Low voltage drop
- High Reliability Solderless Fuse
- High pulse resistance
- Lead-free – compatible with lead-free solders and higher temperature profiles
- Halogen-free and RoHS compliant

* Largely based on Littelfuse internal AEC-Q200 test plan

Agency Approvals

AGENCY	AGENCY FILE NUMBER	AMPERE RANGE
	E10480	1A–5A
	R50395911	1A–5A

Electrical Characteristics for Series

% of Ampere Rating	Opening Time
125%	1 hour, Minimum
200%	2 minutes, Maximum
1000%	1 second, Maximum

Applications

- Li-ion battery packs used in electric vehicles
- Battery Management Systems (BMS)
- Sense lines
- HV DC/DC converter

Additional Information



Datasheet





Resources



Samples

Electrical Specifications by Item

Ampere Rating (A)	Amp Code	Max Voltage Rating (V)	Interrupting Rating	Nominal Cold Resistance (Ohms) ¹	Nominal Melting I ² t (A ² sec)	Nominal Voltage Drop (mV)	Nom Power Dissipation (mW)	Agency Approvals	
									
1.00	001.	500	1500A @ 350VDC 100A @ 500VDC 100A @ 350VAC	0.0780	0.80	105	105	X	X
1.25	1.25			0.0630	1.25	105	131	X	X
1.60	01.6			0.0473	2.30	98	157	X	X
2.00	002.			0.0322	4.70	91	182	X	X
2.50	02.5	450	1500A @ 125VDC 100A @ 500VDC 100A @ 350VAC	0.0267	6.90	88	220	X	X
3.15	3.15			0.0196	13.35	79	249	X	X
4.00	004.			0.0152	21.30	79	316	X	X
5.00	005.			0.0119	35.00	79	395	X	X

Notes:

1. Cold resistance measured at less than 10% of rated current at 23°C.
2. I²t values slated for 10xIn opening time
3. If you have special electrical characteristic needs, please contact Littelfuse to discuss application specific options.

Temperature Re-rating Curve

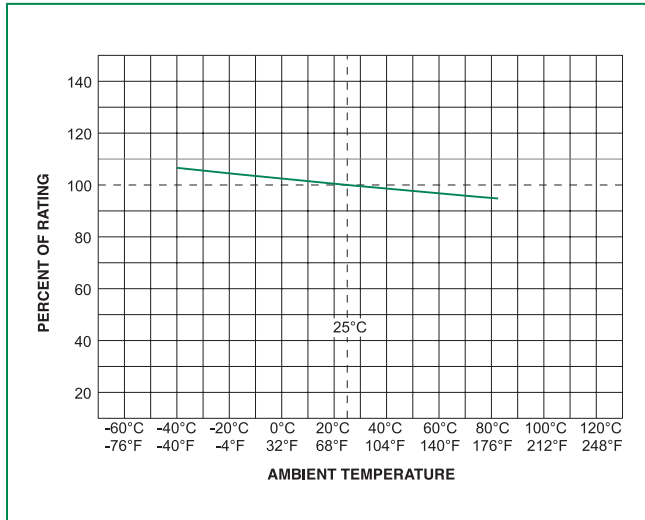

Note:

1. Re-rating depicted in this curve is in addition to the standard derating of 25% for continuous operation.

Average Time Current Curves

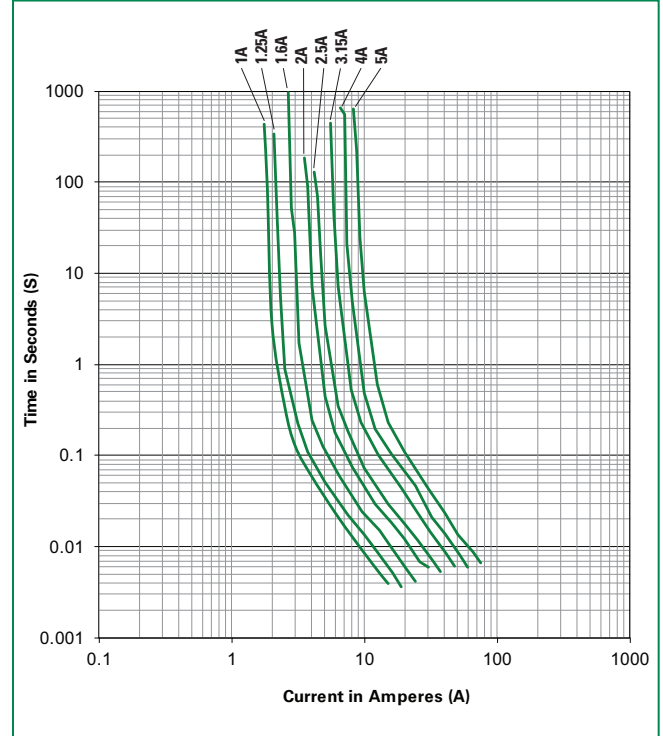

Soldering Parameters

Reflow Condition	Pb – Free assembly	
Pre Heat	- Temperature Min ($T_{s(min)}$)	150°C
	- Temperature Max ($T_{s(max)}$)	200°C
	- Time (Min to Max) (t_s)	60 – 120 secs
Average ramp up rate (Liquidus Temp (T_L) to peak)		5°C/second max.
$T_{s(max)}$ to T_L - Ramp-up Rate		5°C/second max.
Reflow	- Temperature (T_L) (Liquidus)	217°C
	- Temperature (t_L)	60 – 90 seconds
Peak Temperature (T_p)		260 ^{+0/-5} °C
Time within 5°C of actual peak Temperature (t_p)		20 – 40 seconds
Ramp-down Rate		5°C/second max.
Time 25°C to peak Temperature (T_p)		8 minutes max.
Do not exceed		260°C

Wave Soldering Parameters	260°C Peak Temperature, 3 seconds max.
---------------------------	--

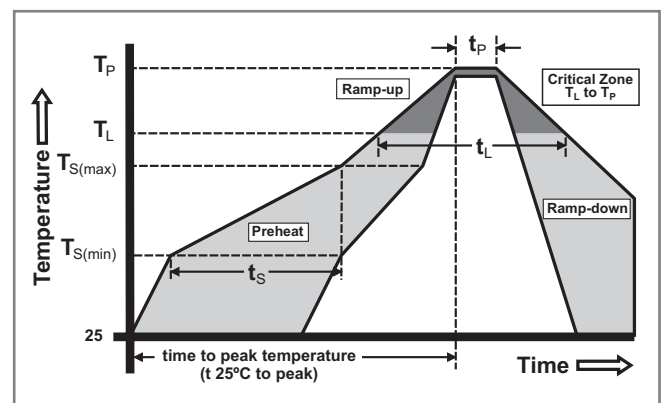

Product Characteristics

Materials	Body: Plastic UL 94 V-0 Cap: Tin Plated Brass
Product Marking	Body: Brand Logo, Current Rating, Voltage Rating, Series, Date Code
Solderability	JESD22-B102E Method 1
Resistance to Soldering Heat	MIL-STD-202 Method 210 Test Condition K

Operating Temperature	-40°C to +85°C with proper derating
Climatic Category	IEC 60068-1, -2-1, -2-2, -2-78 (-40°C to +85°C/21 days)
Vibration	MIL-STD-202 Method 201 and 204
Moisture Sensitivity Level	J-STD-020, Level 1

Dimensions

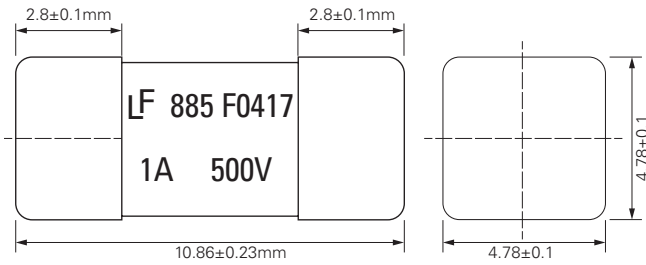

Recommended Pad Layout

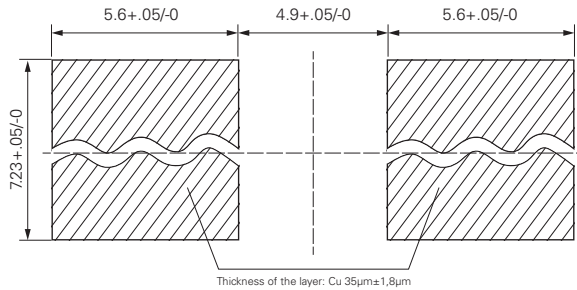

Part Numbering System

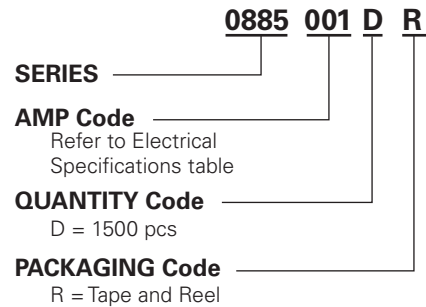

Date Code Information

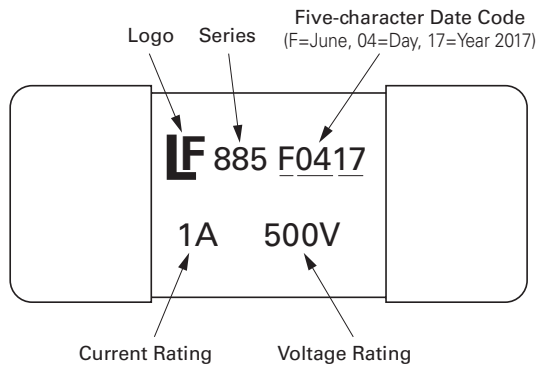

Packaging

Packaging Option	Packaging Specification	Quantity	Quantity & Packaging Code
Tape and Reel	EIA-481-D	1500	D

Disclaimer Notice - Information furnished is believed to be accurate and reliable. However, users should independently evaluate the suitability of and test each product selected for their own applications. Littelfuse products are not designed for, and may not be used in, all applications. Read complete Disclaimer Notice at www.littelfuse.com/disclaimer-electronics.