

# Straight BNC Receptacle to 5mm RCA Phono Jack Adaptor

pro-SIGNAL



## Specifications

Adaptor Type	: Straight Adaptor
Connector Type A	: BNC Receptacle
Connector Type B	: 5mm RCA Phono Jack

## Diagram

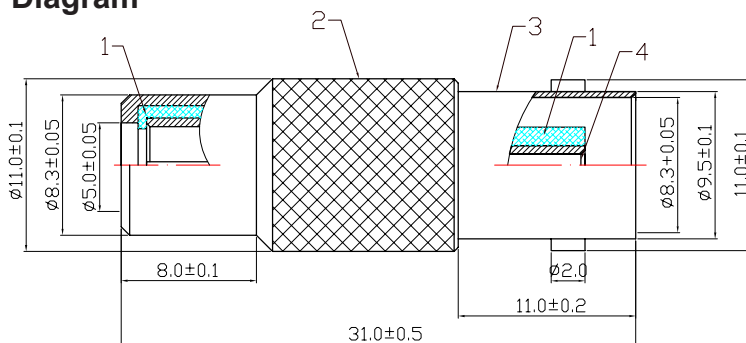

Dimensions : Millimetres

## Material Specifications

No.	Parameter	Material
1	Dielectric	POM
2	Body	Copper
3	BNC Female Body	Zinc
4	Pin	Copper

## Part Number Table

Description	Part Number
Straight BNC Receptacle to 5mm RCA Phono Jack Adaptor	PS000187

**Important Notice** : This data sheet and its contents (the "Information") belong to the members of the Premier Farnell group of companies (the "Group") or are licensed to it. No licence is granted for the use of it other than for information purposes in connection with the products to which it relates. No licence of any intellectual property rights is granted. The Information is subject to change without notice and replaces all data sheets previously supplied. The Information supplied is believed to be accurate but the Group assumes no responsibility for its accuracy or completeness, any error in or omission from it or for any use made of it. Users of this data sheet should check for themselves the Information and the suitability of the products for their purpose and not make any assumptions based on information included or omitted. Liability for loss or damage resulting from any reliance on the Information or use of it (including liability resulting from negligence or where the Group was aware of the possibility of such loss or damage arising) is excluded. This will not operate to limit or restrict the Group's liability for death or personal injury resulting from its negligence. pro-SIGNAL is the registered trademark of the Group. © Premier Farnell Limited 2016.

www.element14.com  
 www.farnell.com  
 www.newark.com  
 www.cpc.co.uk

pro-SIGNAL