

### Data Sheet

---

#### Description

The HSMC-C191-T0000 ChipLED is a surface-mount LED that comes in an industrial standard 1.6 mm × 0.8 mm footprint. It offers industry-leading performance by using efficient and high brightness AllnGaP material. Its small form-factor allows flexible board or custom design, and the LED can be closely mounted, thus offering a cost-effective solution.

This LED has a wide viewing angle. Coupled with high performance and a small package size, these features make this device an ideal candidate for applications that require uniform light distribution, high brightness, and less board space.

This device is ideal for use applications, such as industrial equipment, consumer electronics, gaming, home appliances, and black and white goods markets.

#### Features

- LED with AllnGaP die
- Surface mount device with 0603 footprint
- Top emitting package
- Compatible with reflow soldering
- Taped in 8-mm carrier tape on a 7-in. diameter reel

#### Applications

- Pushbutton backlighting
- Icon backlighting
- Status indicator

#### Device Selection Guide

Part Number	Emitting Color
HSMC-C191-T0000	Red

**CAUTION:** LEDs are Class 1A ESD sensitive per ANSI/ESDA/JEDEC JS-001. Observe appropriate precautions during handling and processing. Refer to Application Note AN-1142 for additional details.

## Package Dimensions

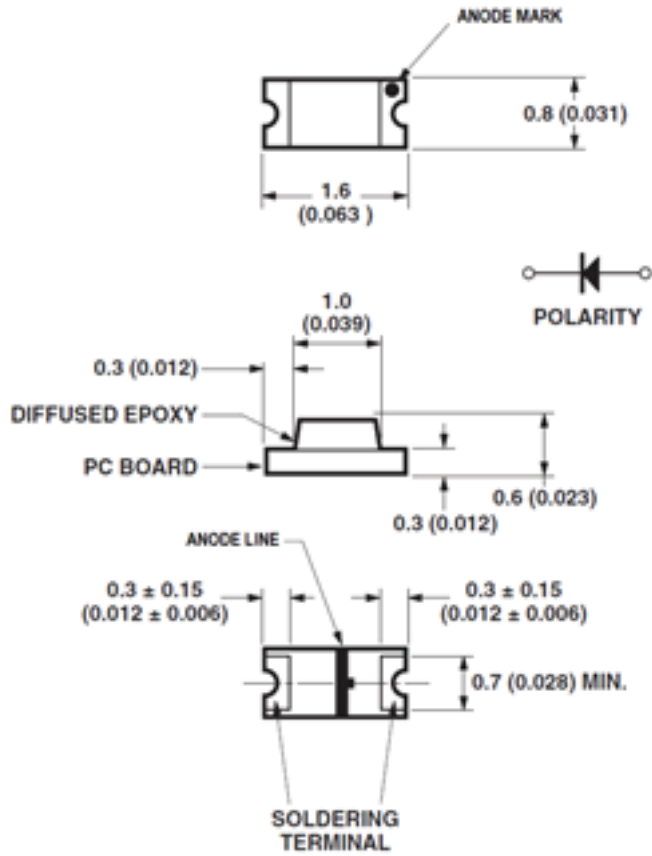

### NOTE

1. All dimensions are in millimeters (in.).
2. Tolerance  $\pm 0.1$  mm ( $\pm 0.004$  in.) unless otherwise specified.

## Absolute Maximum Value at $T_J = 25^\circ\text{C}$

Parameter	Rating	Unit
DC Forward Current <sup>a</sup>	25	mA
Peak Forward Current <sup>b</sup>	100	mA
Power Dissipation	60	mW
LED Junction Temperature	95	$^\circ\text{C}$
Operating Temperature Range	-40 to +85	$^\circ\text{C}$
Storage Temperature Range	-40 to +85	$^\circ\text{C}$

- a. Derate as shown in [Figure 7](#).  
 b. Duty factor = 1/10; pulse width = 0.1ms.

## Optical Characteristics ( $T_J = 25^\circ\text{C}$ , $I_F = 20\text{ mA}$ )

Color	Luminous Intensity, $I_v$ (mcd) <sup>a</sup>			Peak Wavelength, $\lambda_p$ (nm)	Dominant Wavelength, $\lambda_d$ (nm) <sup>b</sup>	Viewing Angle, $2\theta_{1/2}$ ( $^\circ$ ) <sup>c</sup>
	Min.	Typ.	Max.	Typ.	Typ.	Typ.
Red	285	450	1125	637	626	125

- a. The luminous intensity is measured at the mechanical axis of the LED package. The actual peak of the spatial radiation pattern may not be aligned with the axis.  
 b. The dominant wavelength is derived from the CIE chromaticity diagram and represents the perceived color of the device.  
 c.  $\theta_{1/2}$  is the off axis angle where the luminous intensity is  $\frac{1}{2}$  the peak intensity.

## Electrical Characteristics ( $T_J = 25^\circ\text{C}$ , $I_F = 20\text{ mA}$ )

Color	Forward Voltage, $V_F$ (V) <sup>a</sup>		Reverse Voltage, $V_R$ at $I_R = 100\ \mu\text{A}$ <sup>b</sup>	Thermal Resistance, $R_{\theta_{jp}}$ ( $^\circ\text{C}/\text{W}$ )
	Min.	Max.	Min.	Typ.
Red	1.6	2.4	5	300

- a. Forward voltage tolerance  $\pm 0.1\text{V}$ .  
 b. Reverse voltage indicates product final test. Long-term reverse bias is not recommended.

## Bin Information

### Luminous Intensity Bin Limits (CAT)

Bin ID	Intensity (mcd)	
	Min.	Max.
T	285	450
U	450	715
V	715	1125

Tolerance =  $\pm 15\%$ .

### Color Bin (BIN) – Red

Bin ID	Dominant Wavelength (nm)	
	Min.	Max.
—	620	635

Tolerance =  $\pm 1$  nm.

**Figure 1 Spectral Power Dissipation**

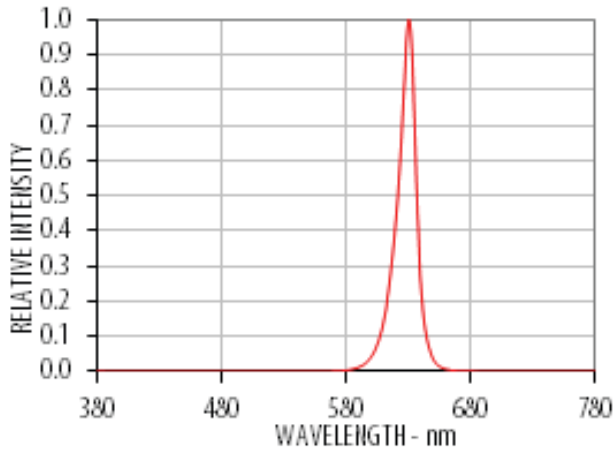

**Figure 2 Relative Intensity vs. Forward Current**

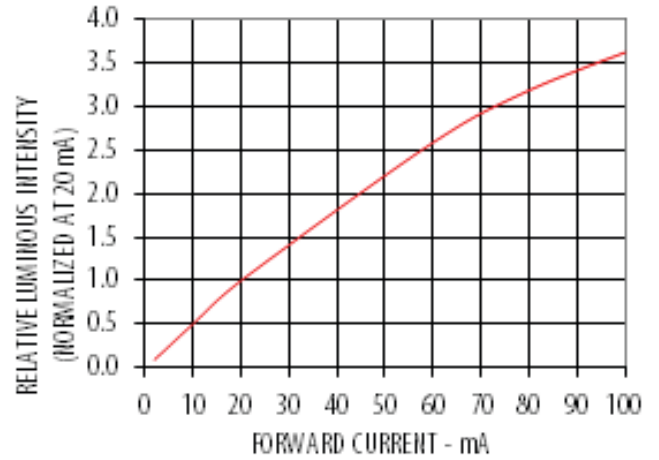

**Figure 3 Forward Current vs. Forward Voltage**

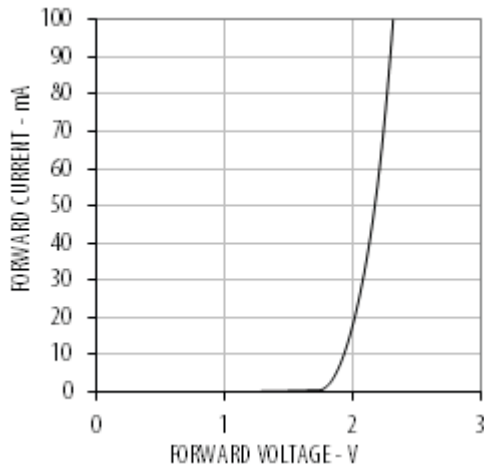

**Figure 4 Dominant Wavelength Shift vs. Forward Current**

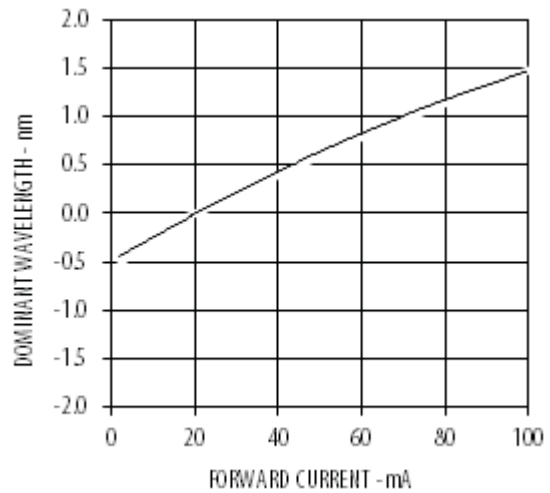

**Figure 5 Radiation Pattern**

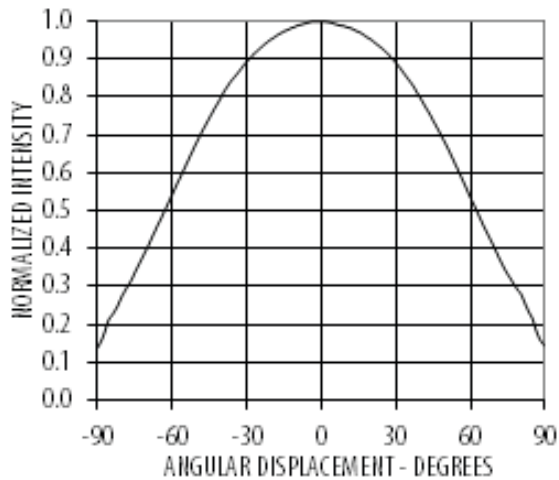

**Figure 6 Relative Intensity vs. Temperature**

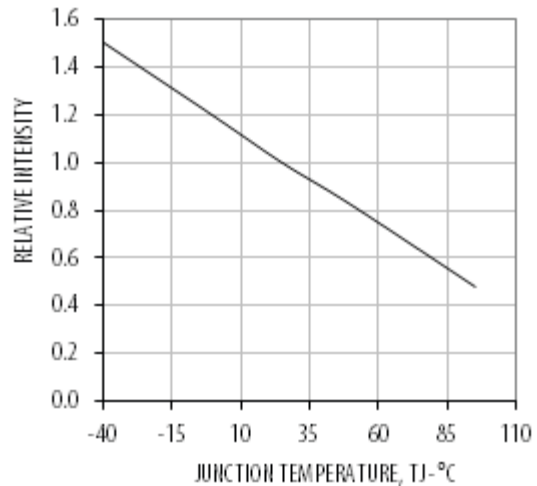

**Figure 7 Derating Curve**

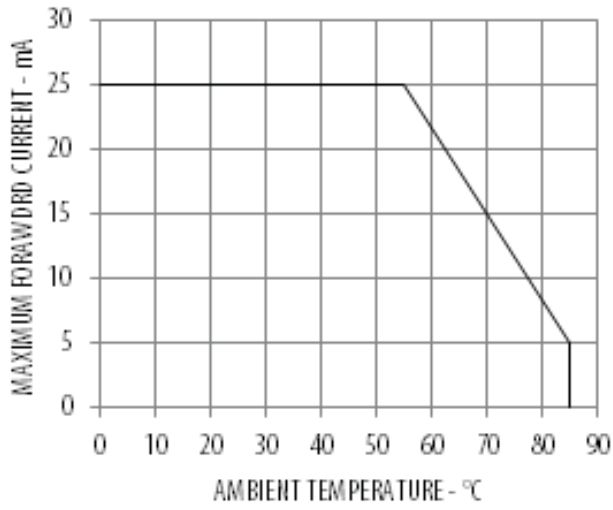

**Recommended Solder Pad**

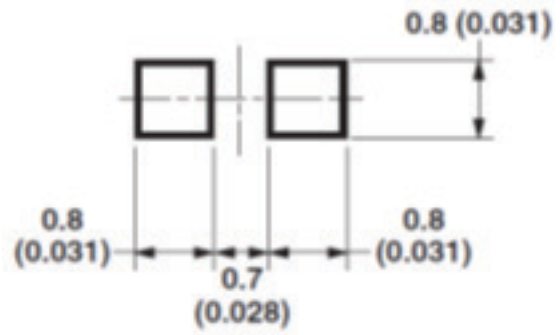

**Reel Orientation**

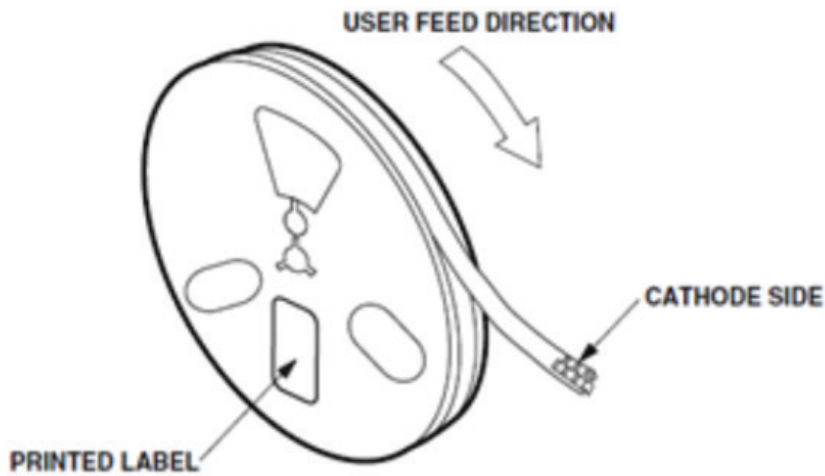

## Reel Dimensions

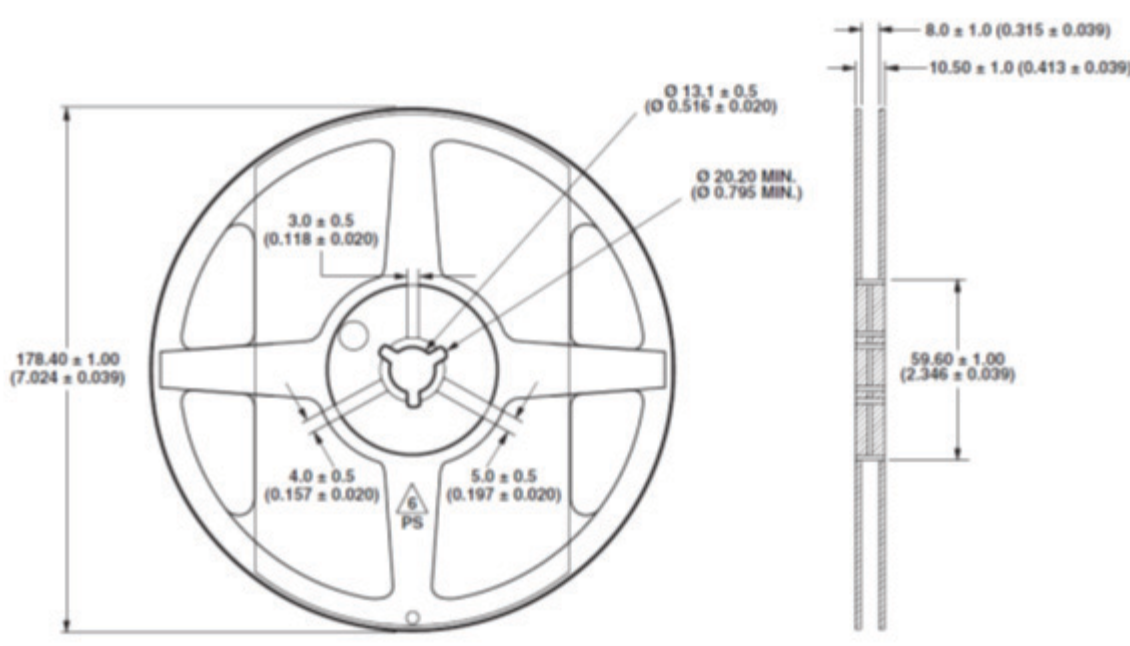

## Carrier Tape Dimensions

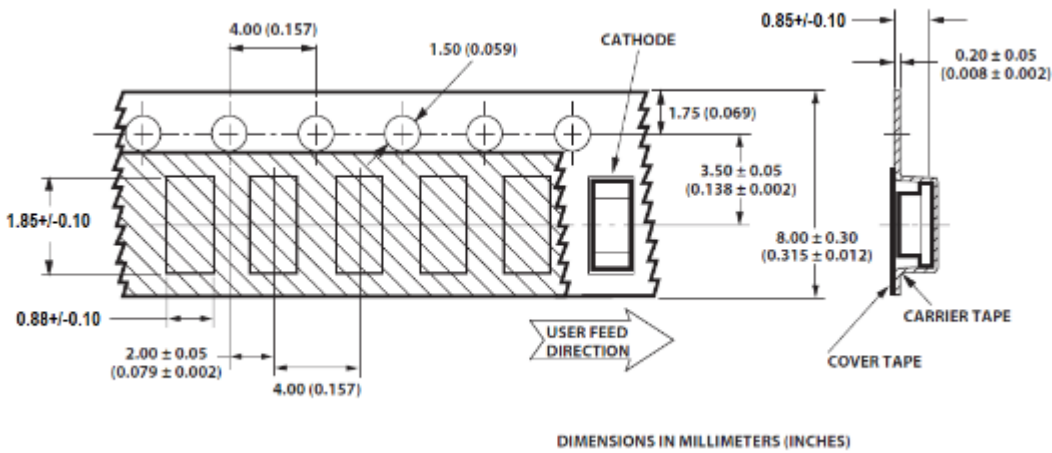

## Soldering

Figure 8 Recommended Reflow Soldering Condition

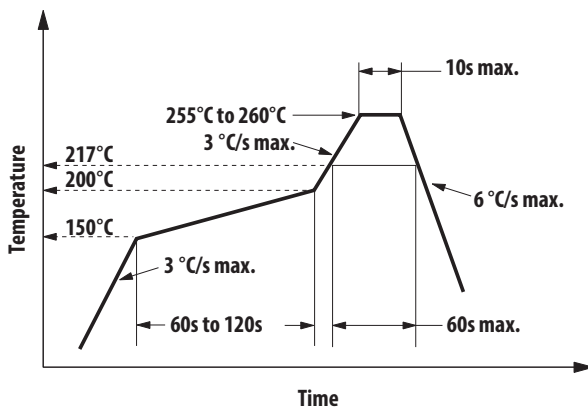

- Do not perform reflow soldering more than twice. Observe necessary precautions when handling moisture-sensitive device as stated in the next section.
- Do not apply any pressure or force on the LED during reflow and after reflow while the LED is still hot.
- Use reflow soldering to solder the LED. But if it is unavoidable (such as rework), manual hand soldering may be used but must be strictly controlled to the following conditions:
  - Soldering iron tip temperature = 310°C max.
  - Soldering duration = 2s max.
  - Number of cycles = One only
  - Power of the soldering iron = 50W max.
- Do not touch the LED package body with the soldering iron except confirm before for the soldering terminals as it might damage the LED.
- Check whether the functionality and performance of the LED is affected by hand soldering.

## Precautionary Notes

### Handling of Moisture-Sensitive Devices

This product has a Moisture Sensitive Level 2a rating per JEDEC J-STD-020. Refer to Broadcom Application Note AN5305, *Handling of Moisture Sensitive Surface Mount Devices*, for additional details and a review of proper handling procedures.

- Before use:
  - An unopened moisture barrier bag (MBB) can be stored at < 40°C / 90% RH for 12 months. If the actual shelf life has exceeded 12 months and the humidity indicator card (HIC) indicates that baking is not required, it is safe to reflow the LEDs per the original MSL rating.
  - Do not open the MBB prior to assembly (for example, for IQC).
- Control after opening the MBB:
  - Read the HIC immediately upon opening the MBB.
  - Keep the LEDs < 30°C / 60% RH at all times, and complete all high temperature-related processes, such as soldering, curing, or rework, within 672 hours.
- Control for unfinished reel:
 

Store unused LEDs in a sealed MBB with desiccant or desiccator at < 5% RH.
- Control of assembled boards:
 

If the PCB soldered with the LEDs is to be subjected to other high temperature processes, store the PCB in a sealed MBB with desiccant or desiccator at < 5% RH to ensure that all LEDs have not exceeded their floor life of 672 hours.
- Baking is required if the following conditions exist:
  - The HIC indicator is not blue at 10% and is pink at 5%.
  - The LEDs are exposed to conditions of > 30°C / 60% RH at any time.
  - The LED floor life exceeded 672 hours.

The recommended baking condition is: 60°C ± 5°C for 20 hours.

Bake the LED only once.



---

## Application Precautions

- The drive current of the LED must not exceed the maximum allowable limit across temperature as stated in the data sheet. Constant current driving is recommended to ensure consistent performance.
- Circuit design must cater for the entire range of forward voltage ( $V_F$ ) of the LEDs to ensure that the intended drive current can always be achieved.
- If the LED is to be used with an LED of another color to achieve color mixing, Broadcom does not guarantee the consistency of the resultant color. Contact a Broadcom sales representative for these applications.
- The LED exhibits slightly different characteristics at different drive currents, which might result in larger variation of its performance (for example, intensity, wavelength, and forward voltage). Set the application current as close as possible to the test current to minimize these variations.
- The LED is not intended for reverse bias. Use other appropriate components for such purposes. When driving the LED in matrix form, ensure that the reverse bias voltage does not exceed the allowable limit of the LED.
- Avoid rapid change in ambient temperatures, especially in high-humidity environments, because they cause condensation on the LED.
- If the LED is to be used in harsh environments, protect the LED against damages caused by rain water, dust, oil, corrosive gases, external mechanical stress, and so on.

## Eye Safety Precautions

LEDs may pose optical hazards when in operation. Do not look directly at operating LEDs because it might be harmful to the eyes. For safety reasons, use appropriate shielding or personal protection equipment.

## Disclaimer

Broadcom's products are not specifically designed, manufactured, or authorized for sale as parts, components, or assemblies for the planning, construction, maintenance, or direct operation of a nuclear facility or for use in medical devices or applications. The customer is solely responsible, and waives all rights to make claims against Broadcom or its suppliers, for all loss, damage, expense, or liability in connection with such use.

---

For product information and a complete list of distributors, please go to our web site:  
[www.broadcom.com](http://www.broadcom.com).

Broadcom, the pulse logo, Connecting everything, Avago Technologies, Avago, and the A logo are among the trademarks of Broadcom and/or its affiliates in the United States, certain other countries and/or the EU.

Copyright © 2016 by Broadcom. All Rights Reserved.

The term "Broadcom" refers to Broadcom Limited and/or its subsidiaries. For more information, please visit [www.broadcom.com](http://www.broadcom.com).

Broadcom reserves the right to make changes without further notice to any products or data herein to improve reliability, function, or design.

Information furnished by Broadcom is believed to be accurate and reliable. However, Broadcom does not assume any liability arising out of the application or use of this information, nor the application or use of any product or circuit described herein, neither does it convey any license under its patent rights nor the rights of others.

HSMC-C191-T0000-DS100 – December 16, 2016



Lead (Pb) Free  
RoHS 6 fully  
compliant