

SPECIFICATION

Part No. : **AP.25E.07.0054A**

Product Name : 25mm One Stage GPS/GALILEO Active Patch
Antenna Module with front-end Saw Filter

Features : Industry leading GPS/GALILEO antenna
performance
35mm*35mm*4.50mm (Ground Plane)
54mm Ø1.13 I-PEX MHFI (U.FL)
15dB LNA
Wide Input Voltage 1.8V to 5.5V
Low Power Consumption
ROHS Compliant



1. Introduction

The AP.25E has been designed specifically for embedded (inside device) integration with GPS/GALILEO receiver modules where there is a GSM transmitter nearby and risk of interference and saturation.

The AP.25E combines a 25*25*2mm advanced low profile ceramic patch antenna with a one stage LNA and a front-end SAW filter with ultra thin coaxial cable.

The Ground Plane size of 35*35mm combined with the larger size GPS/GALILEO Patch, gives this solution a performance increase in gain of 1~2dB. It also helps shields the patch antenna from noise and increases performance at low elevations. Taoglas active antenna modules utilise XtremeGain™ technology for the highest sensitivity in the industry. The AP.25E consists of 2 functional blocks – the LNA and also the patch antenna.

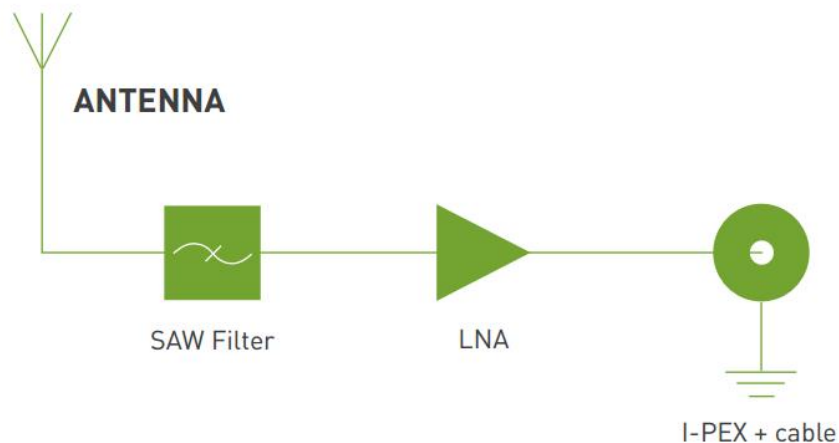

The AP.25E has a SAW filter on the front of it. The main use of the AP.25E would be for small devices where the GSM transmitter is close to the GPS/GALILEO antenna, it helps avoid burn-out of the LNA or the module due to interference from the GSM transmitter at out band frequencies.

2. Specification

2.1. Patch Antenna

Parameter	Specification
Frequency	1575.42 ± 1.023MHz
Gain @ Zenith	+1.5 dBic Typ. @ Zenith
Polarization	RHCP
Axial Ratio	3.0dB max. @Zenith
Patch Dimension	25*25*2mm

2.2. LNA

Parameter	Specification																
Frequency	1575.42 ± 1.023MHz																
Outer Band Attenuation	F0=1575.42MHz F0□30MHz 9dB min. F0□50MHz 20dB min. F0□100MHz 25dB min.																
Output Impedance	50Ω																
Output VSWR	2.0 Max																
Pout at 1dB Gain Compression point	Typ. -2dBm Min. -6dBm																
LNA Gain, Power Consumption and Noise Figure																	
	<table border="1"> <thead> <tr> <th>Voltage</th> <th>LNA Gain (Typ)</th> <th>Power Consumption (mA) Typ</th> <th>Noise Figure Typ</th> </tr> </thead> <tbody> <tr> <td>Min. 1.8V</td> <td>14dB</td> <td>3mA</td> <td>2.5dB</td> </tr> <tr> <td>Typ. 3.0V</td> <td>15dB</td> <td>3mA</td> <td>2.5dB</td> </tr> <tr> <td>Max. 5.5V</td> <td>15dB</td> <td>3mA</td> <td>2.5dB</td> </tr> </tbody> </table>	Voltage	LNA Gain (Typ)	Power Consumption (mA) Typ	Noise Figure Typ	Min. 1.8V	14dB	3mA	2.5dB	Typ. 3.0V	15dB	3mA	2.5dB	Max. 5.5V	15dB	3mA	2.5dB
Voltage	LNA Gain (Typ)	Power Consumption (mA) Typ	Noise Figure Typ														
Min. 1.8V	14dB	3mA	2.5dB														
Typ. 3.0V	15dB	3mA	2.5dB														
Max. 5.5V	15dB	3mA	2.5dB														

2.3. Cable* & Connector

Parameter	Specification
RF Cable	Coaxial Cable Ø1.13 ± 0.1mm, length 54 ± 4.5mm
Connector	IPEX MHFI (U.FL)

2.4. Total Specification (through Antenna, LNA, Cable and Connector)

Parameter	Specification
Frequency	1575.42 ± 1.023MHz
Gain	At 5V: 16.5 ± 3dBic At 3V: 16.5 ± 3dBic At 1.8V: 15.5 ± 3dBic
Output Impedance	50Ω
Polarization	RHCP
Output VSWR	Max 2.0
Operation Temperature	-40°C to + 85°C
Storage Temperature	-40°C to + 85°C
Relative Humidity	40% to 95%
Input Voltage	Min:1.8V Typ. 3.0V Max:5V
Antenna	35*35*4.5mm

3. LNA Gain and Out Band Rejection @3.0V

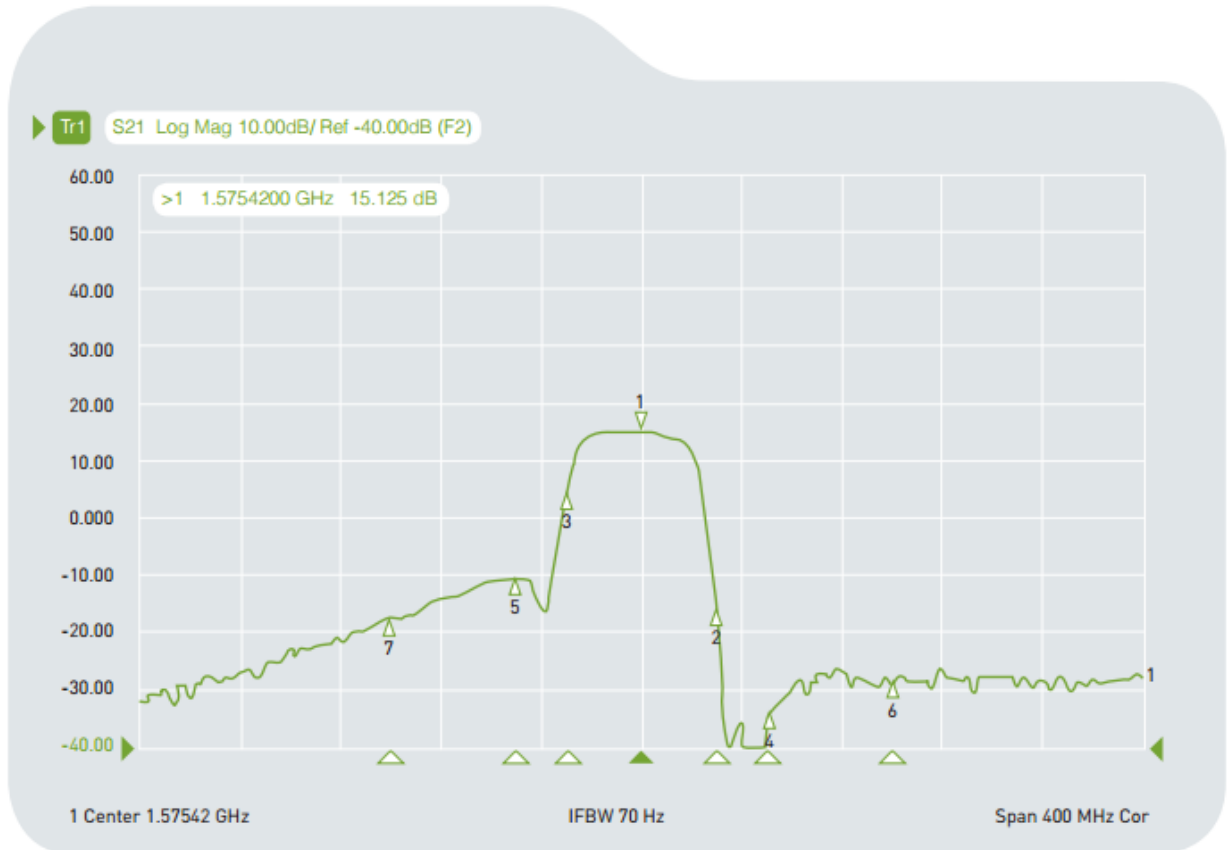

Cg1	Tr1	S21	>1	1.5754200 GHz	15.125 dB
Cg1	Tr1	S21	2	1.6054200 GHz	-15.348 dB
Cg1	Tr1	S21	3	1.5454200 GHz	4.4144 dB
Cg1	Tr1	S21	4	1.6254200 GHz	-34.991 dB
Cg1	Tr1	S21	5	1.5254200 GHz	-10.262 dB
Cg1	Tr1	S21	6	1.6754200 GHz	-28.746 dB
Cg1	Tr1	S21	7	1.4754200 GHz	-17.596 dB

4. LNA Noise Figure @3.0V

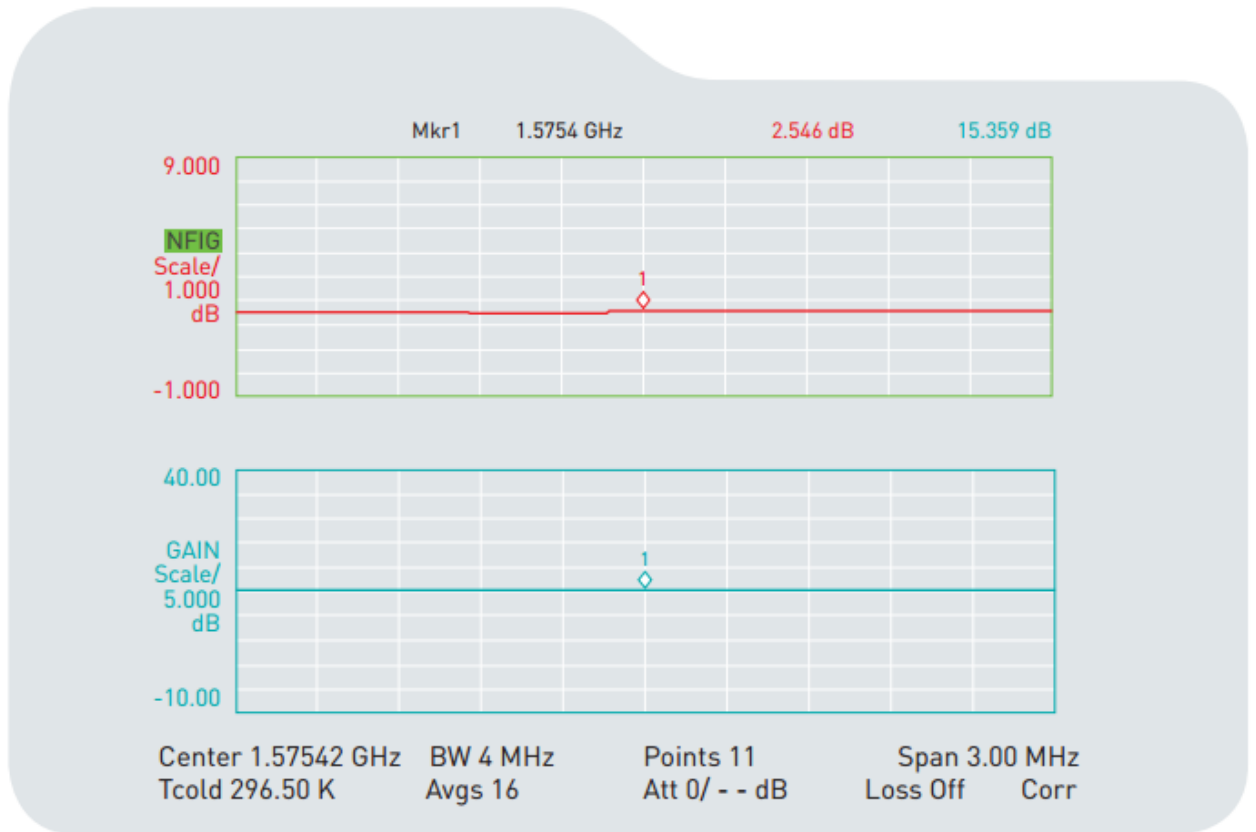

5. Technical Drawing

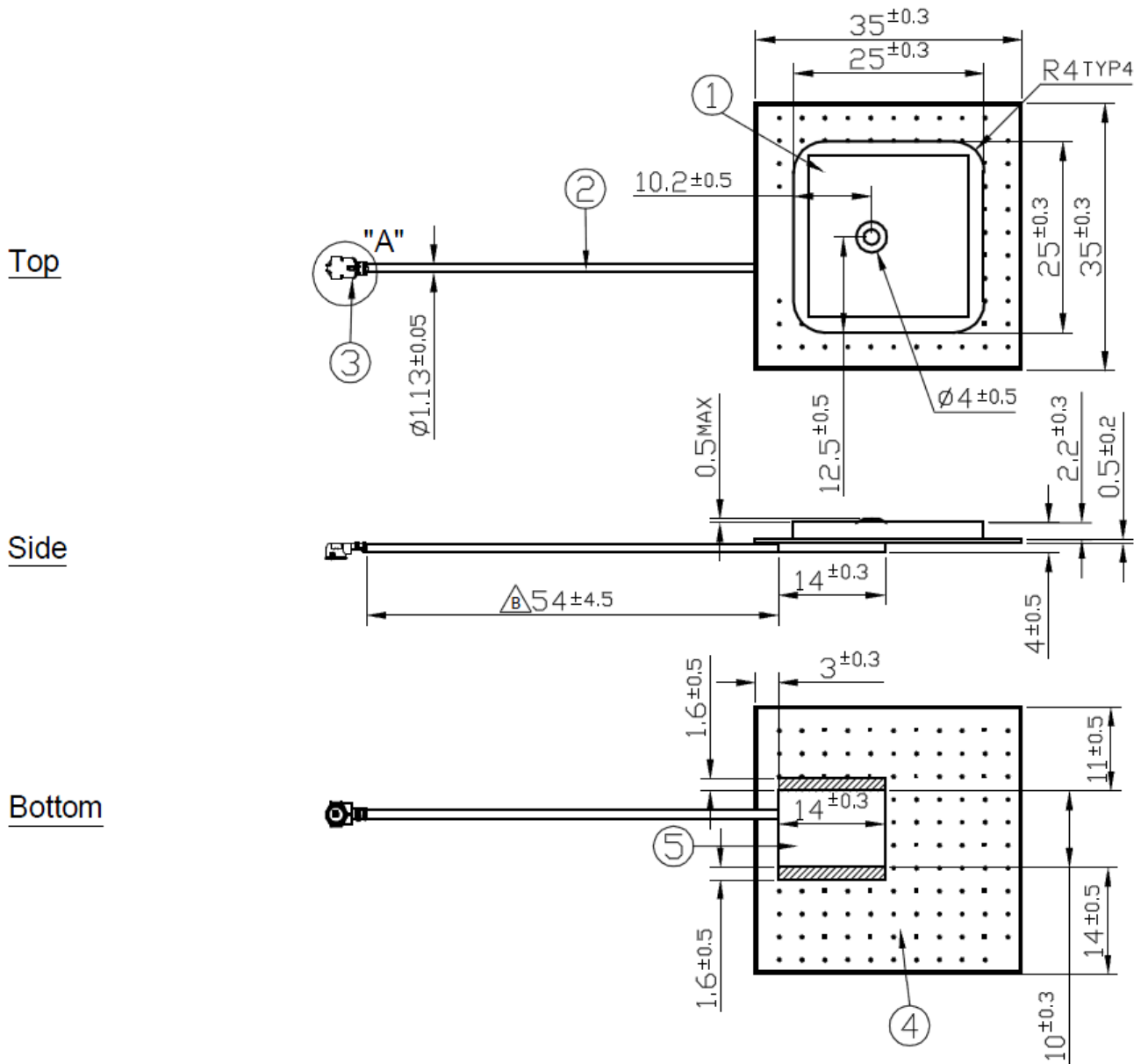



	Name	Material	Finish	QTY
1	AP.25E Patch(25*25*2mm)	Ceramic	Clear	1
2	1.13 Coaxial Cable	FEP	Gray	1
3	IPEX MHF1	Brass	Gold	1
4	AP.25E PCB	FR4 0.5t	Green	1
5	Shielding Case	SPTe (Tin)	Tin Plated	1

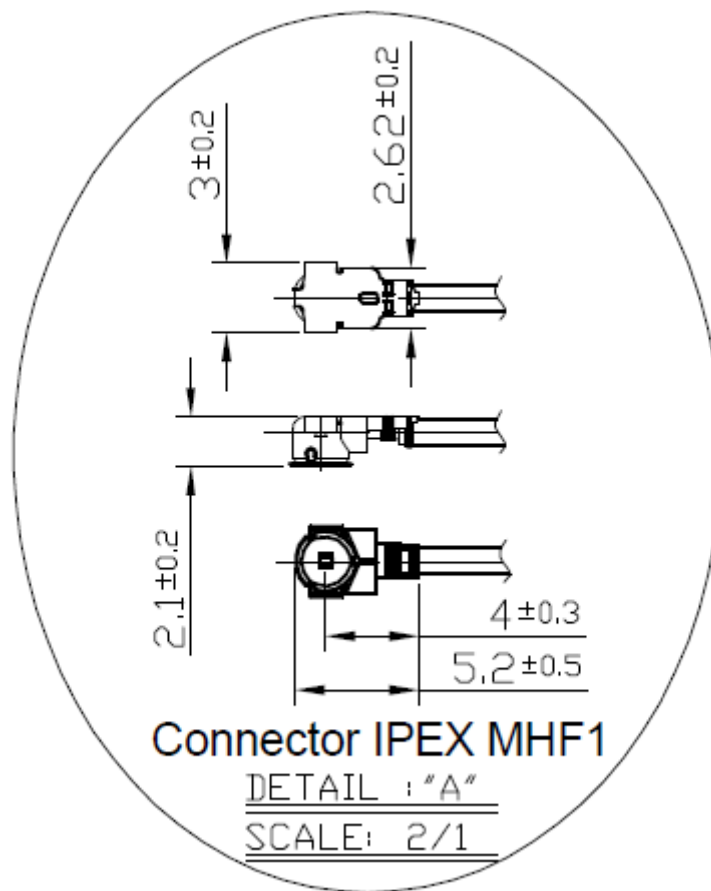

6. Radiation Patterns

6.3 XY Plane Radiation

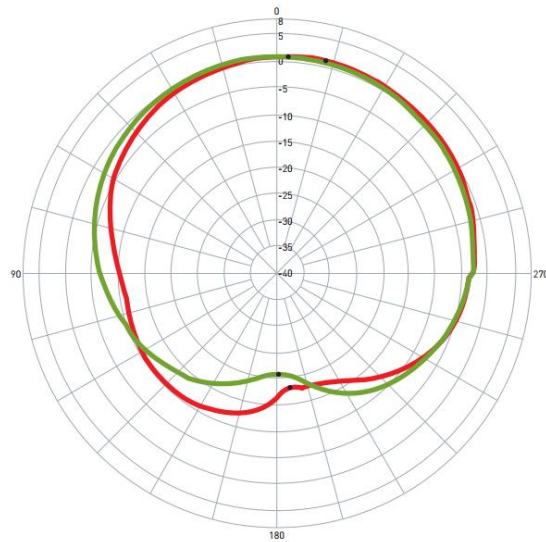

Pattern	Model No.	Test Mode	Freq (MHz)	Max Gain(dBi)	Min Gain(dBi)	Avg. Gain(dBi)	Source Polar.	Date
1	AP.25E.07.0054A	XZ	1579.42	0.86 / 347.00	-18.16 / 187.00	-3.65	RHCP	2010/4/19
2	AP.25E.07.0054A	YZ	1579.42	0.73 / 357.00	-20.87 / 181.00	-3.44	RHCP	2010/4/19

6.1 XZ Plane Radiation

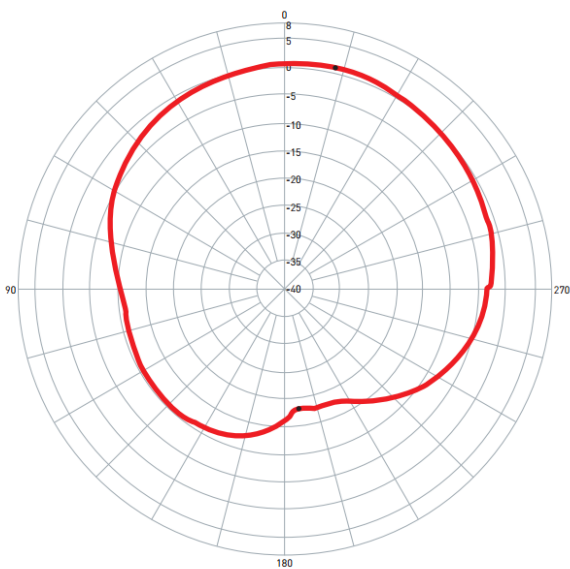

Pattern	Model No.	Test Mode	Freq (MHz)	Max Gain(dBi)	Min Gain(dBi)	Avg. Gain(dBi)	Source Polar.	Date
1	AP.25E.07.0054A	XZ	1579.00	0.86 / 347.00	-18.16 / 187.00	-3.65	RHCP	2010/4/19

6.2 YZ Plane Radiation

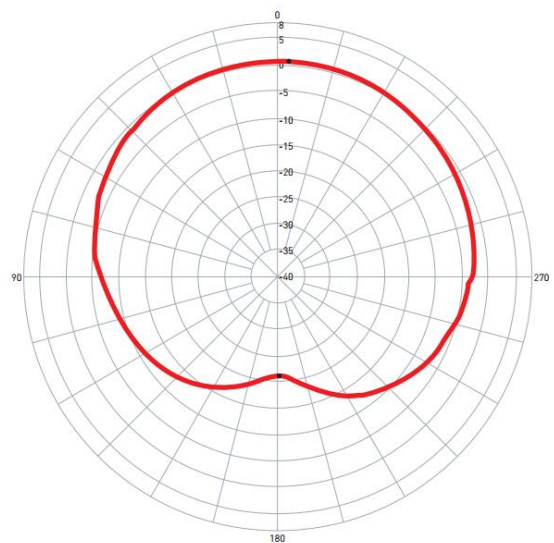

Pattern	Model No.	Test Mode	Freq (MHz)	Max Gain(dBi)	Min Gain(dBi)	Avg. Gain(dBi)	Source Polar.	Date
1	AP.25E.07.0054A	YZ	1579.00	0.73 / 357.00	-20.87 / 181.00	-3.44	RHCP	2010/4/19

7. Plugs Usage Precautions

Mating / unmating

(1) To disconnect connectors, insert the end portion of I-PEX under the connector flanges and pull off vertically, in the direction of the connector mating axis.

(2) To mate the connectors, the mating axes of both connectors must be aligned and the connectors can be mated. The "click" will confirm fully mated connection.

Do not attempt to insert on an extreme angle.

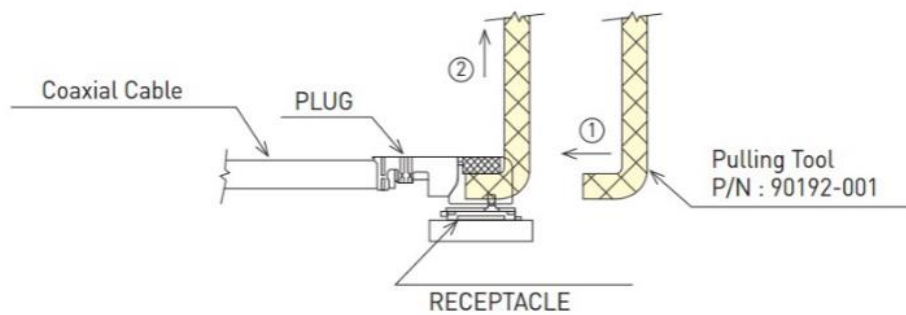

Pull forces on the cable after connectors are mated

After the connectors are mated, do not apply a load to the cable in excess of the values indicated in the diagram below.

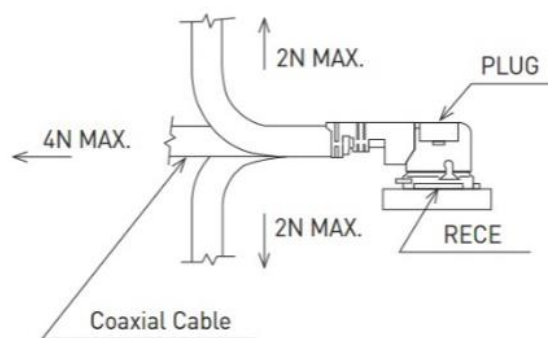

Taoglas makes no warranties based on the accuracy or completeness of the contents of this document and reserves the right to make changes to specifications and product descriptions at any time without notice. Taoglas reserves all rights to this document and the information contained herein.

Reproduction, use or disclosure to third parties without express permission is strictly prohibited.

Copyright © Taoglas Ltd.