

SPECIFICATION

Part Number: **IS.01.B.305111**

Product Name: 433 MHz Heavy Duty Screw Mount Antenna

Features: Hercules Screw-Mount
0dBi ISM 433 MHz Band
3M NFC-200 SMA (M)
29mm*49mm (Diameter)
Waterproof IP67 & IP69K Rated

RoHS Compliant



1. INTRODUCTION

The IS.01 is a high performance 433MHz thread mount antenna for external use on mesh Networks, vehicles and outdoor and indoor assets. It is designed for heavy duty work with extra thick threads. Durable UV resistant PC housing is resistant to vandalism and direct attack. At only 29mm high it complies with the latest EU directives for vehicle height restrictions, whilst also enabling covert operation with a diameter of 49mm. Range of signal travels up to 300m (see range tests below).

The antenna housing is completely waterproof to IP67, and also to IP69K, which means it is waterproof against high pressure water jets used in industrial environments for cleaning.

2. SPECIFICATION

ELECTRICAL	
ANTENNA STANDARD	IS.01 ISM
Operation Frequency (MHz)	400~460 MHz
Peak Gain	1.6 dBi
Average Gain	-3.5 dB
Efficiency	45%
VSWR	<1.8:1
Impedance	50Ω
Polarization	Linear
Radiation Properties	Omni-directional
Max Input Power	5 W

* The IS.01 antenna performance was measured with 30X30 cm metal plate.

MECHANICAL	
Dimensions (mm)	Height=29mm x Diameter=49mm
Cable	3M NFC-200- Fully Customizable
Casing	UV Resistant PC
Base and Thread	Nickel plated steel
Weather proof gasket	CR4305 foam with 3M9448B double-side adhesive
Connector	SMA Male Fully Customizable
Thread Diameter	18 mm
Sealant	Rubber Stopper
Recommended Mounting Torque	24.5N·m
Maximum Mounting Torque	29.4N·m

ENVIRONMENTAL	
Protection	IP67 & IP69K
Corrosion	5% NACI for 48hrs- Nickel plated steel base and thread
Temperature Range	40°C to +85°C
Thermal Shock	100 cycles -40 C to +885 C
Humidity	Non-condensing 65 C 95% RH
Shock (Drop Test)	1m drop on concrete 6 axes
Cable Pull	8Kgf

3. TEST SET UP

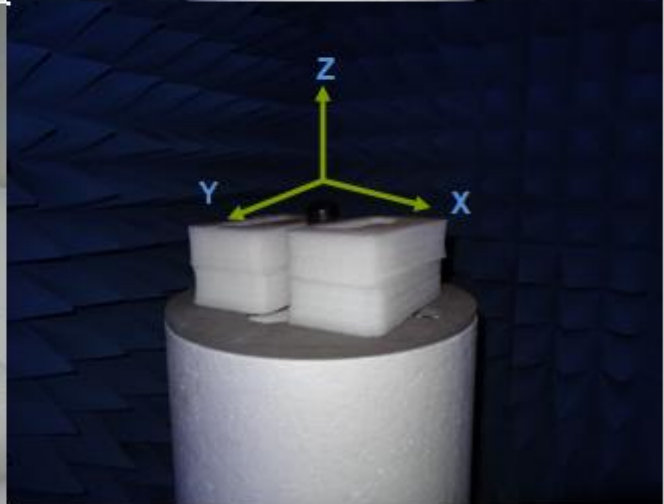
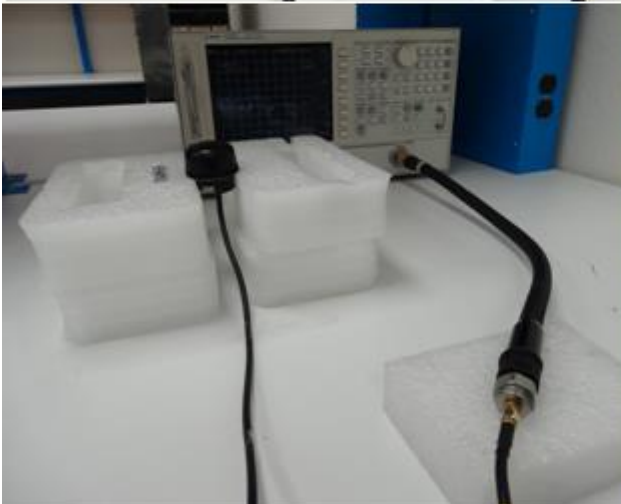
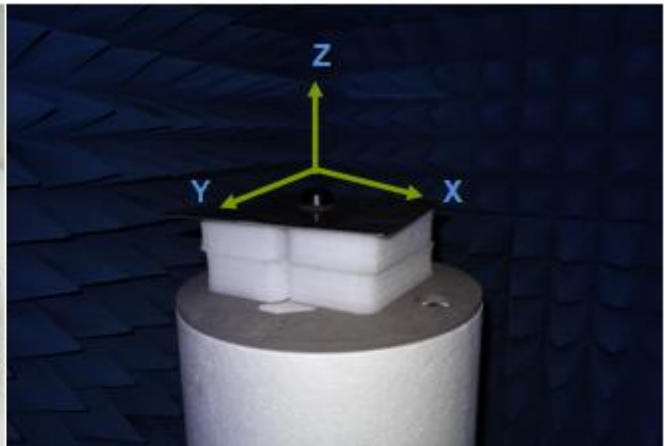
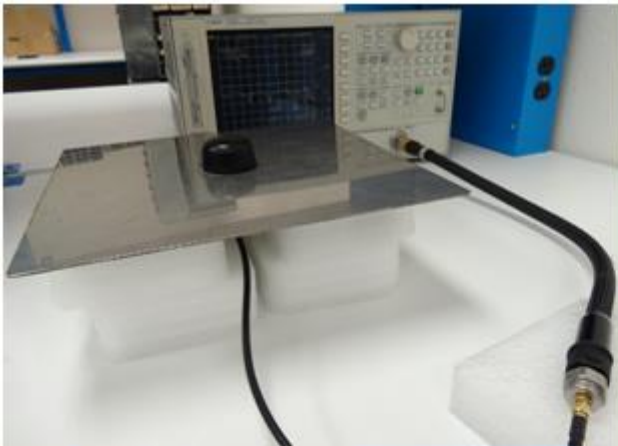

4. ANTENNA PARAMETERS

4.1. Return Loss

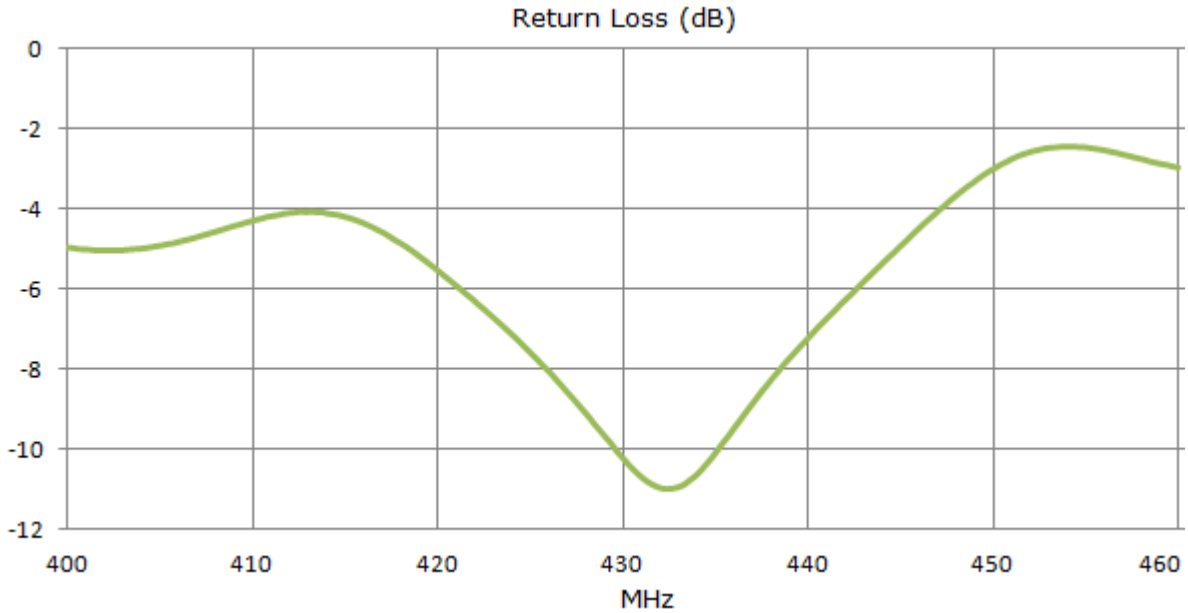

Figure 2 Return loss of IS.01 Antenna in Free Space.



Figure 3 Return Loss of IS.01 Antenna on 30x30 cm metal plate.

4.2. VSWR

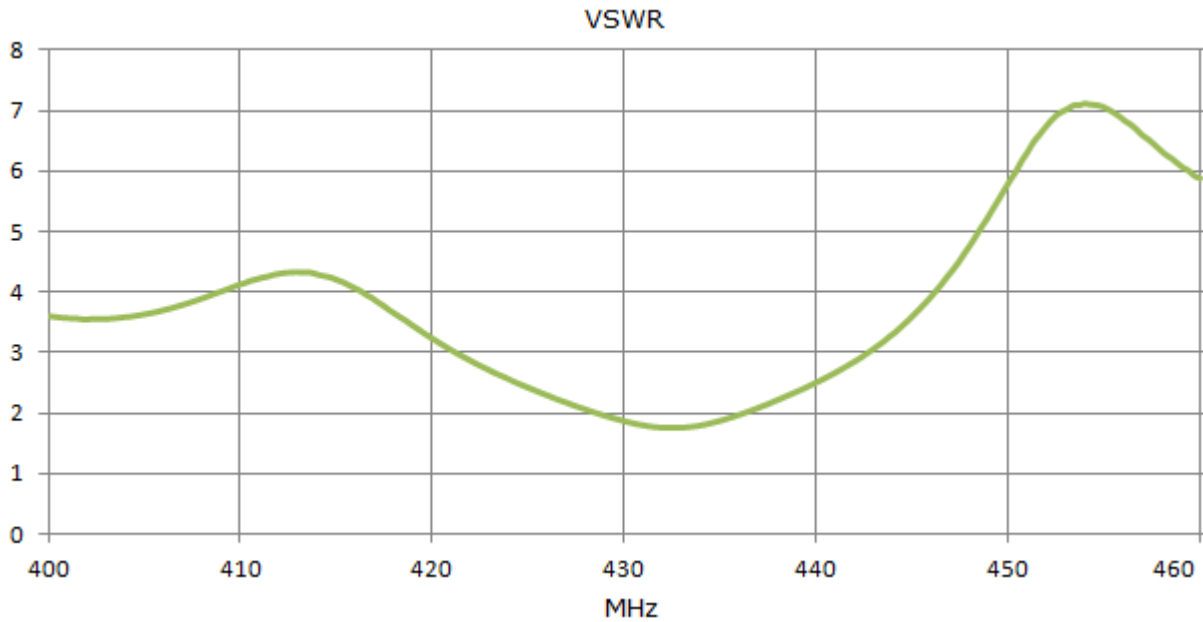

Figure 4 VSWR of IS.01 Antenna in Free Space.

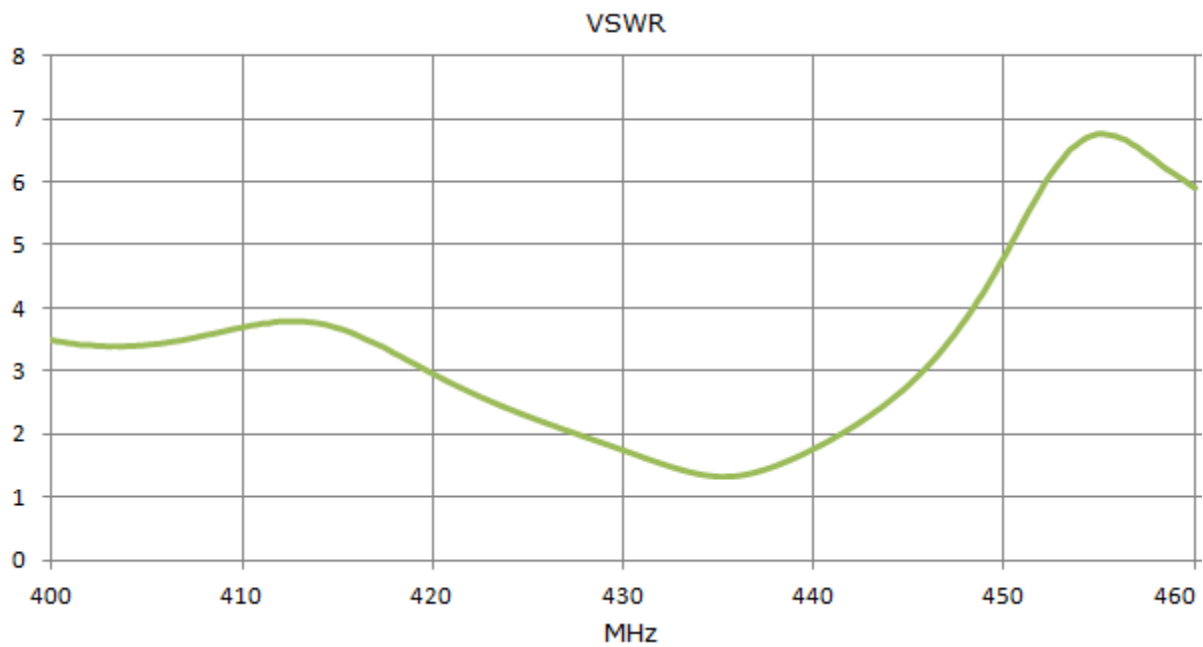

Figure 5 VSWR of IS.01 Antenna on 30x30 cm metal plate.

4.3. Efficiency

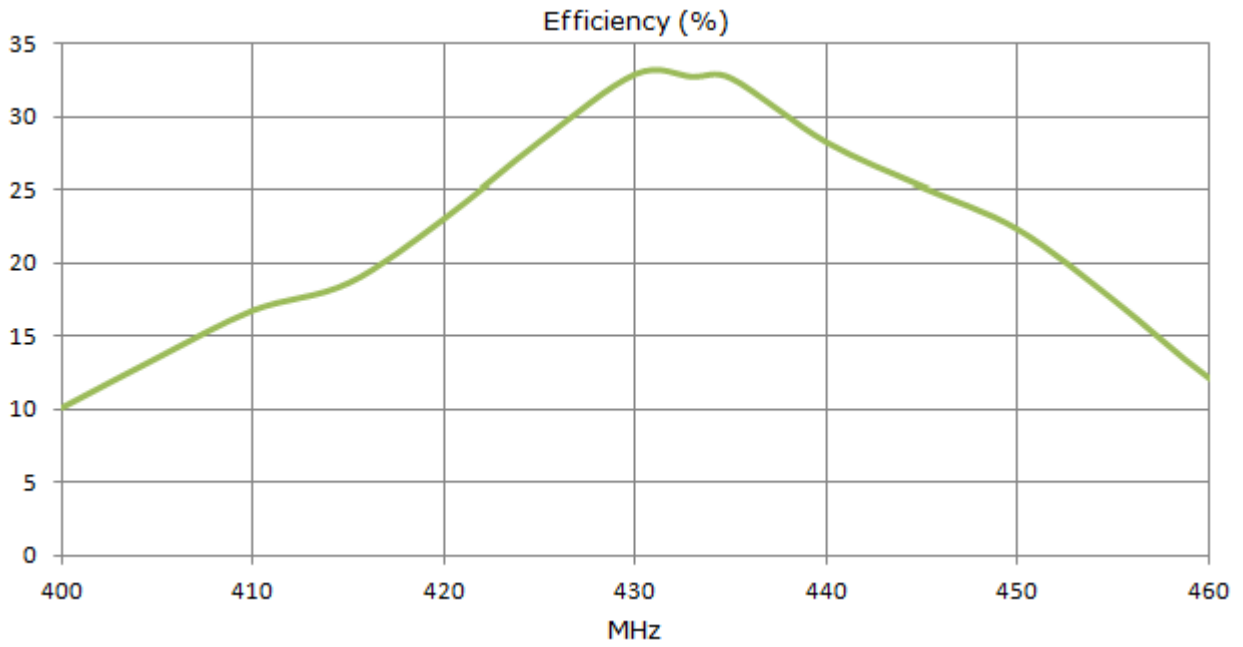

Figure 6 Efficiency of IS.01 Antenna in Free Space.

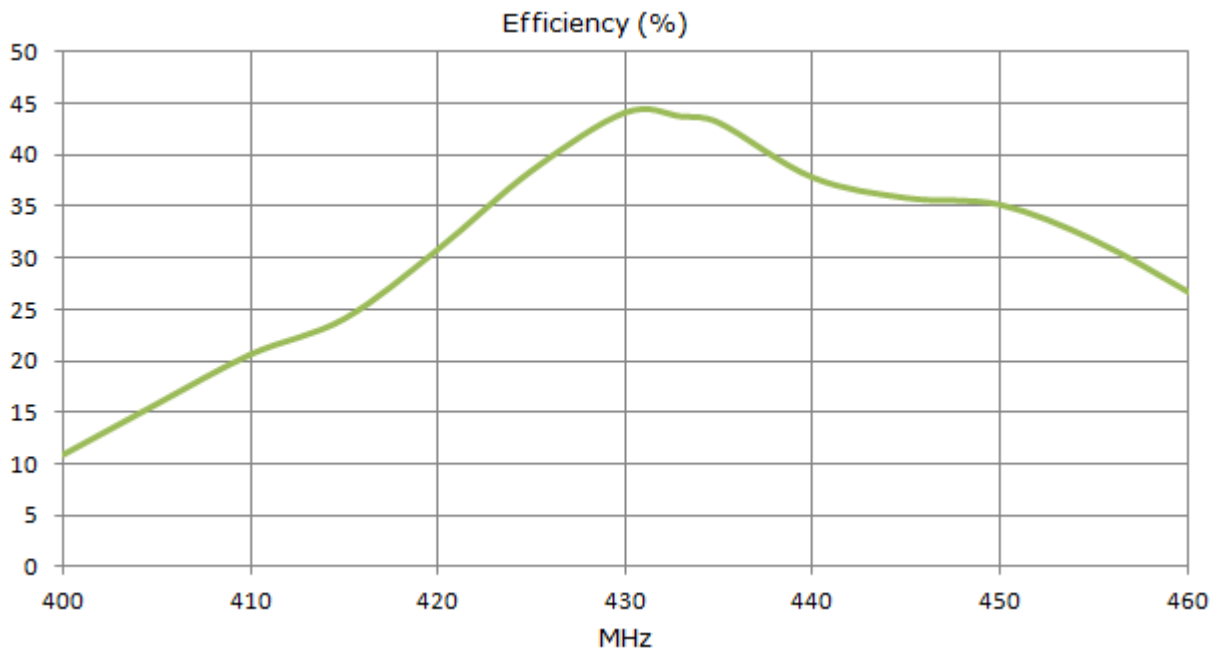

Figure 7 Efficiency of IS.01 Antenna on 30x30 cm metal plate.

4.4. Peak Gain

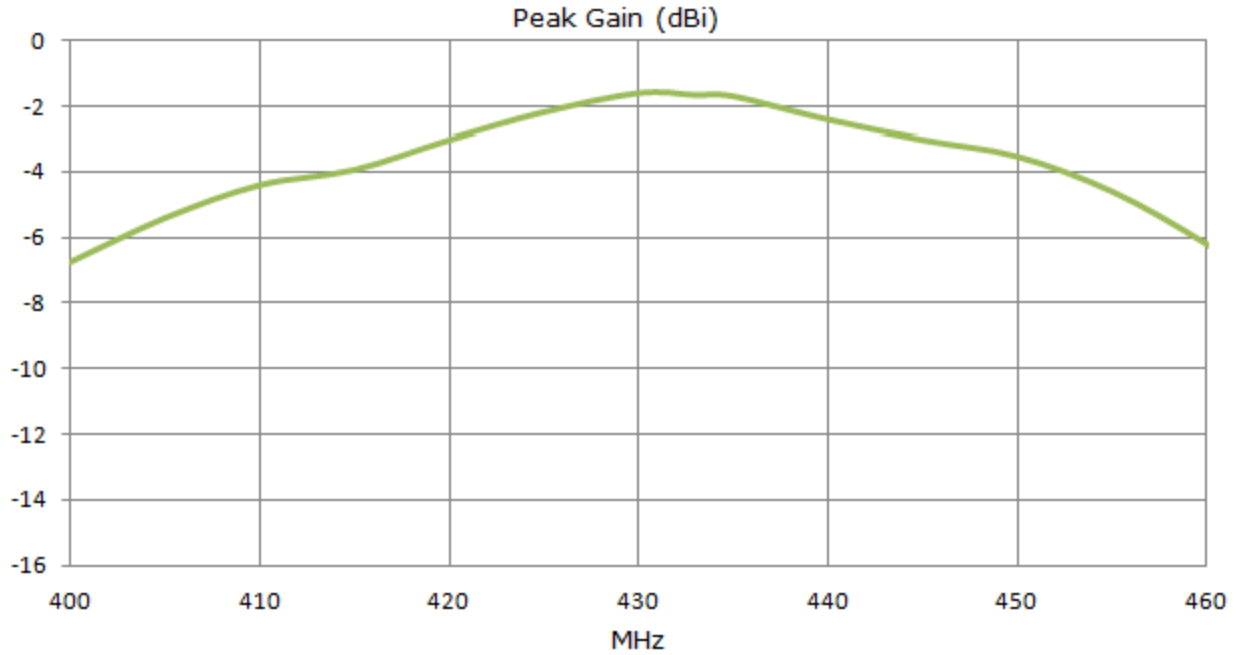

Figure 8 Peak Gain of IS.01 Antenna in Free Space.

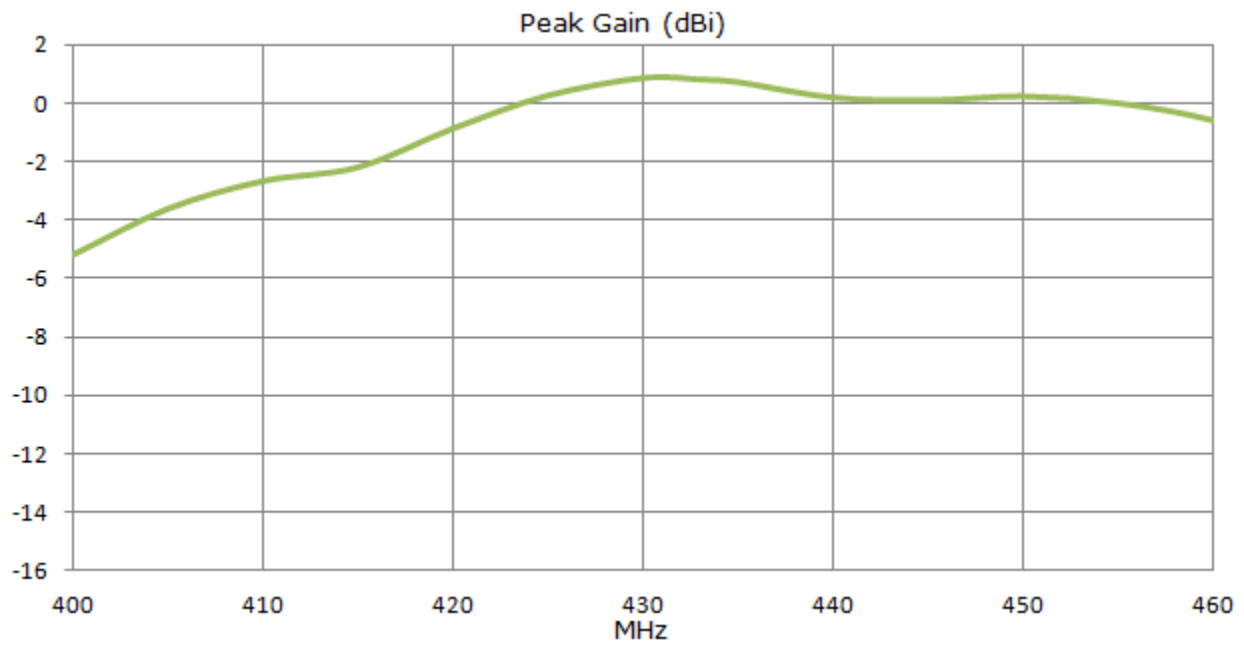

Figure 9 Peak Gain of IS.01 Antenna on 30x30 cm metal plate.

4.5. Average Gain

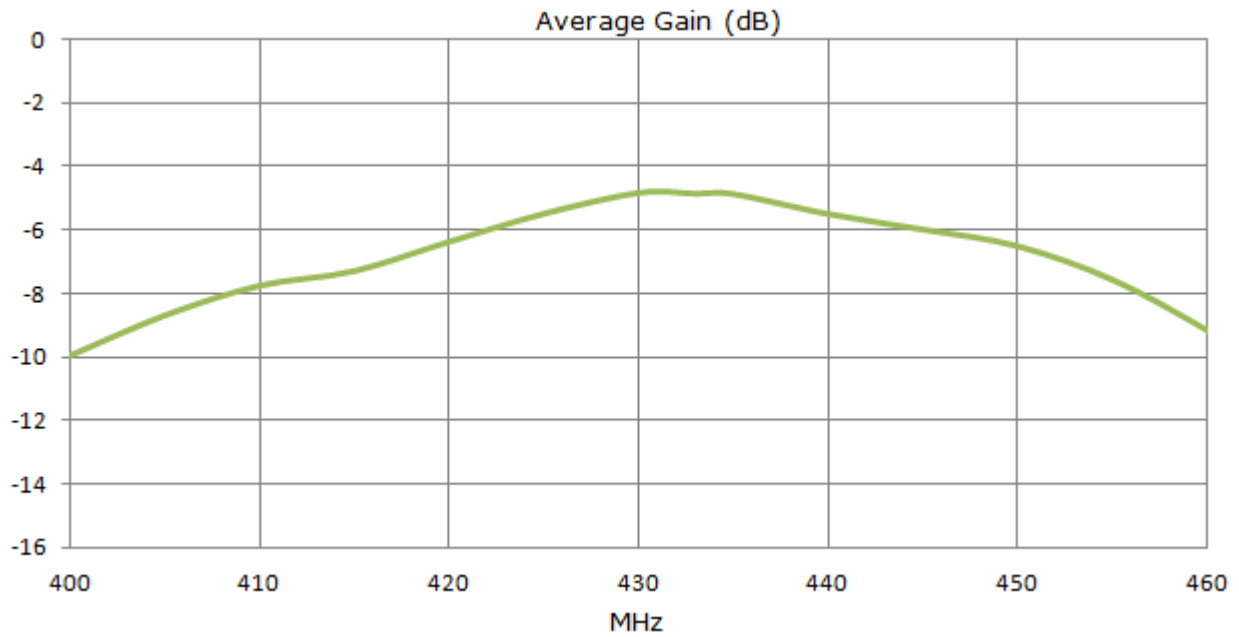

Figure 10 Average Gain of IS.01 Antenna in Free Space.

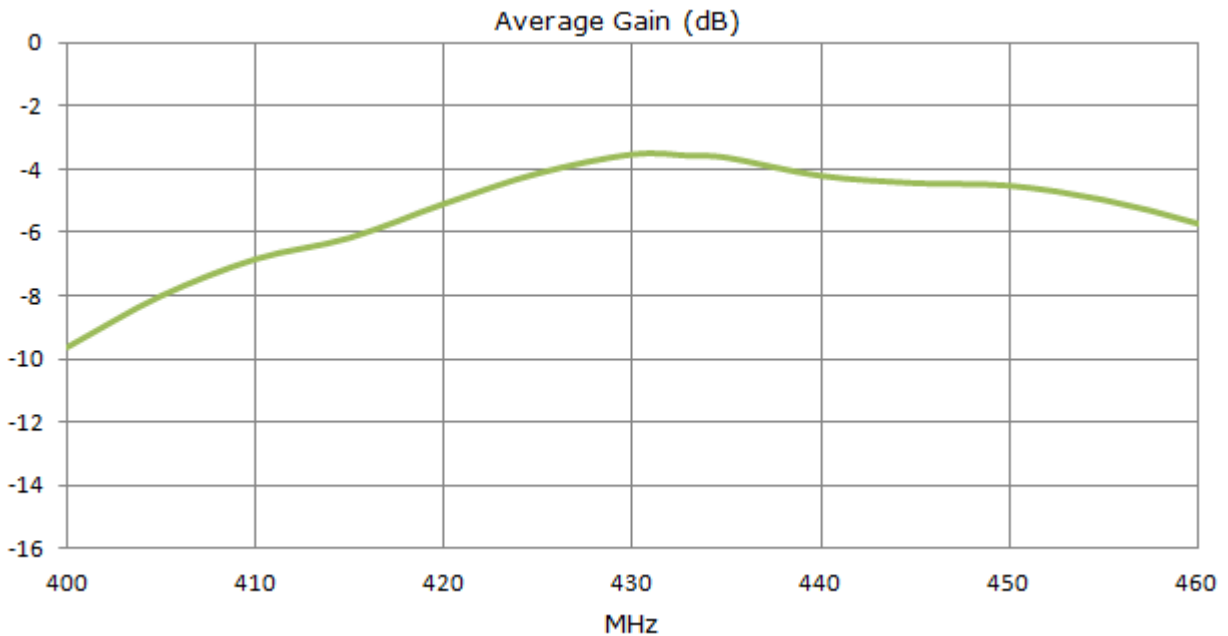

Figure 11 Average Gain of IS.01 Antenna on 30x30 cm metal plate.

4.6. Radiation Pattern

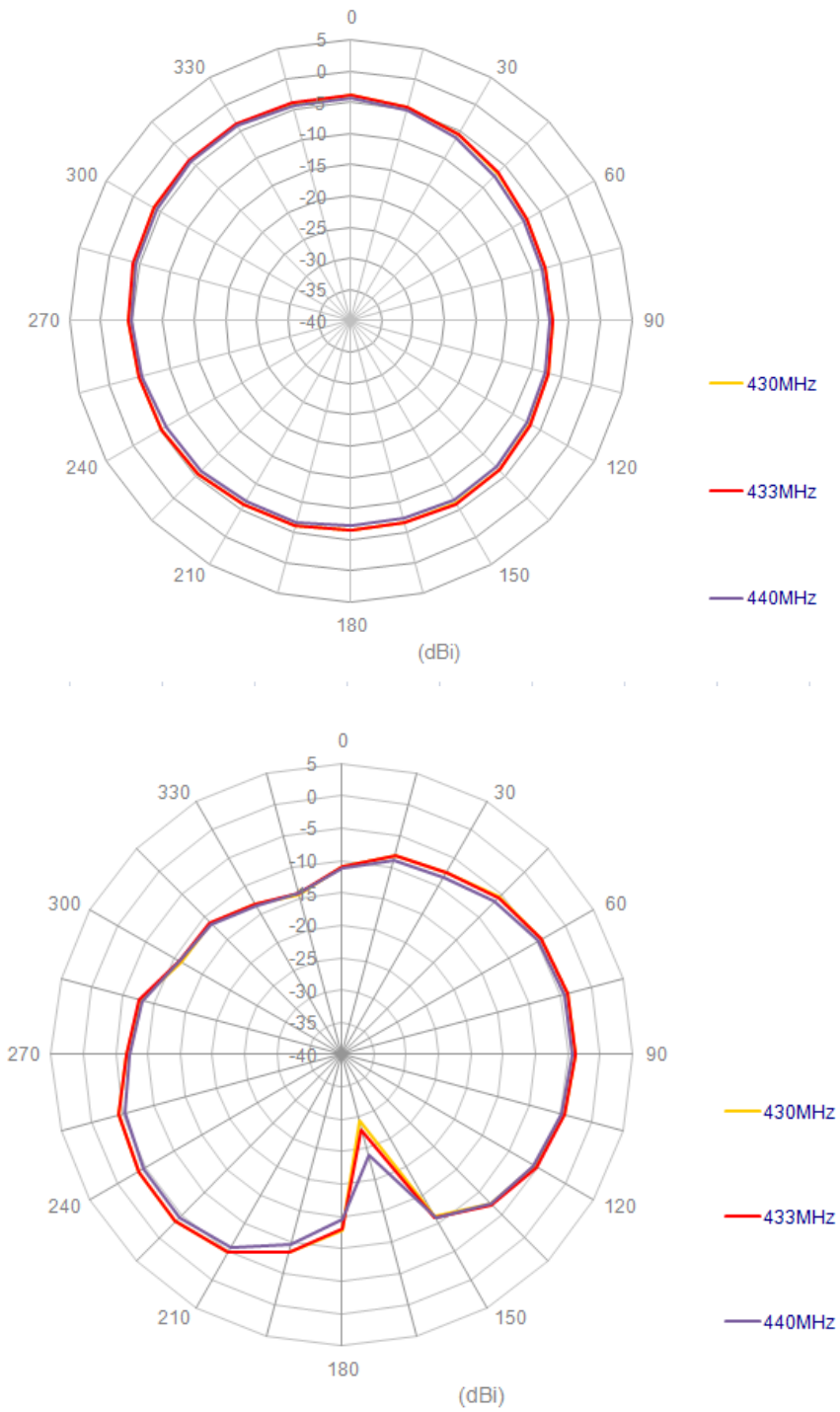

Figure 12 Radiation Pattern of IS.01 Antenna in Free Space.

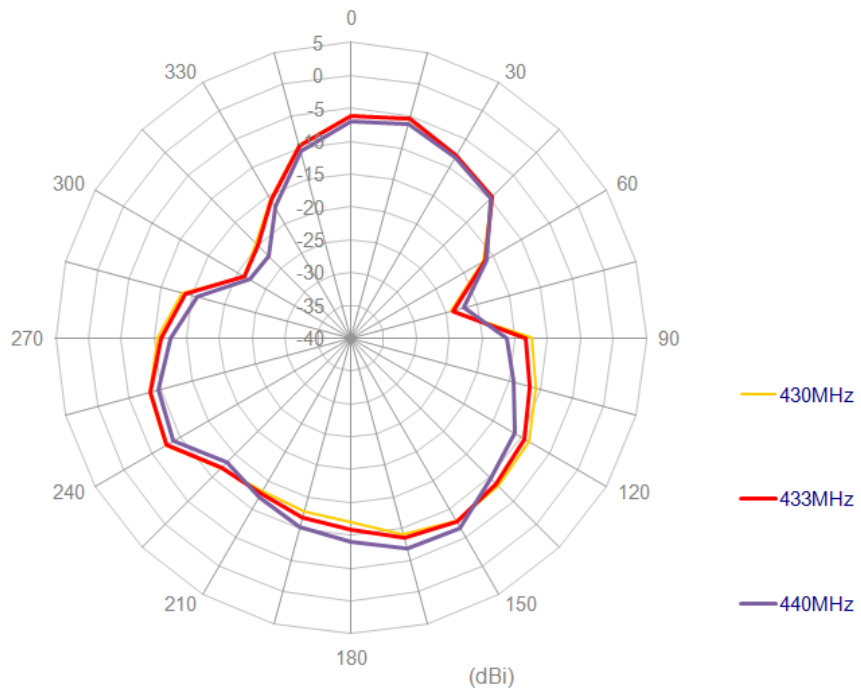
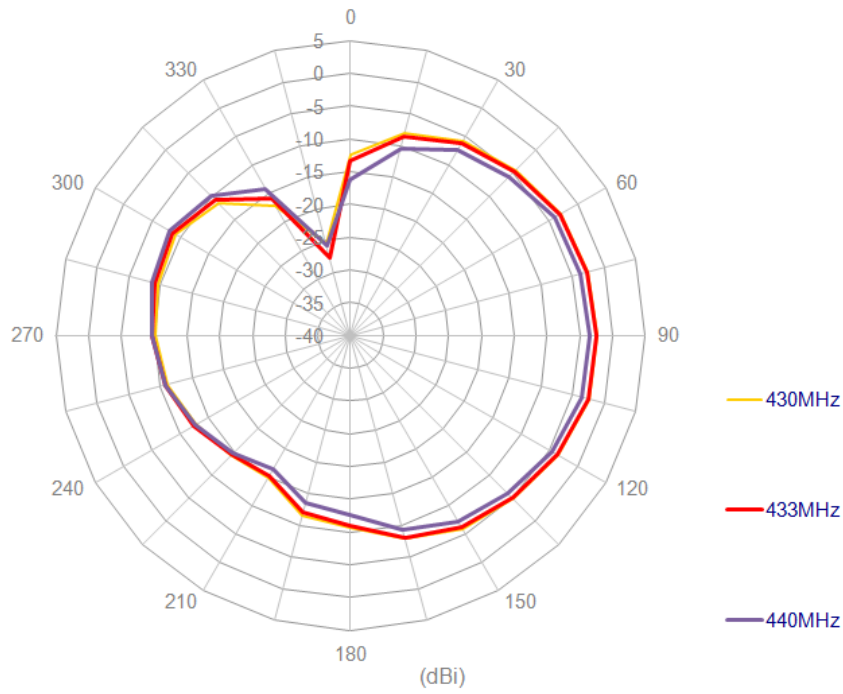
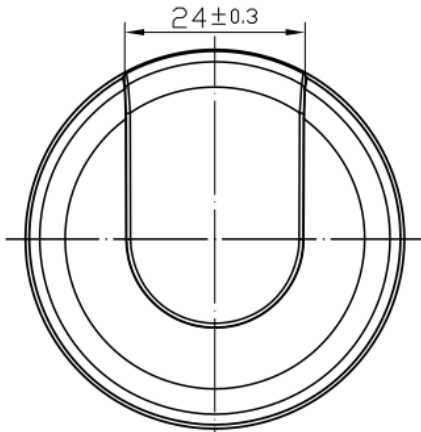

Figure 13 Radiation Pattern of IS.01 Antenna on 30x30cm metal plate.

5. MECHANICAL DRAWING

Top View



Front View

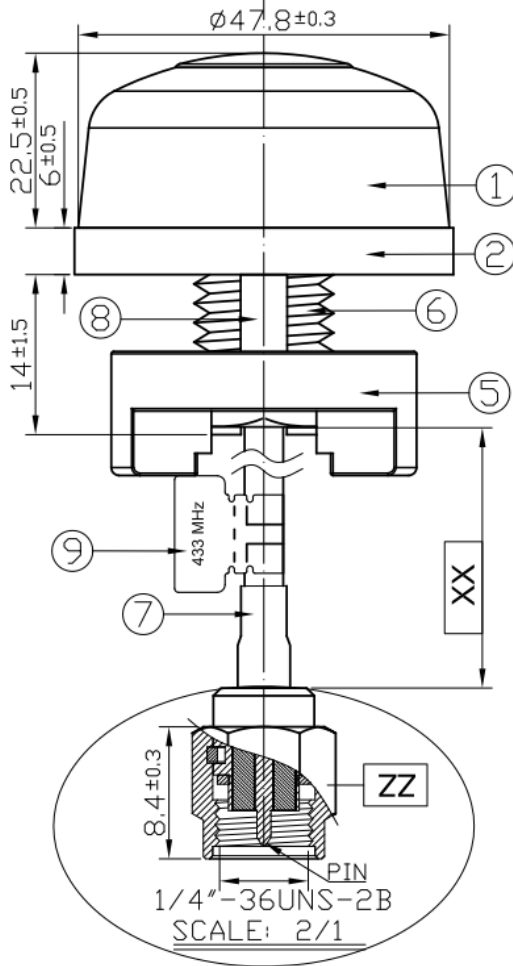

Side View

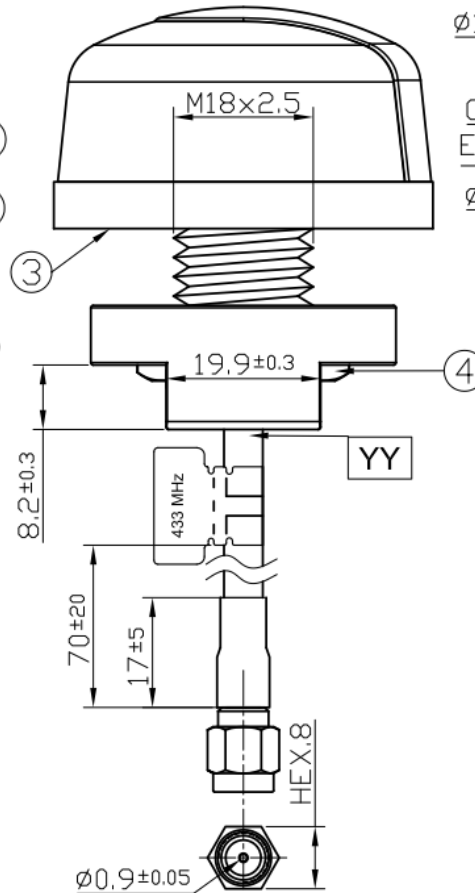

Bottom Thread View

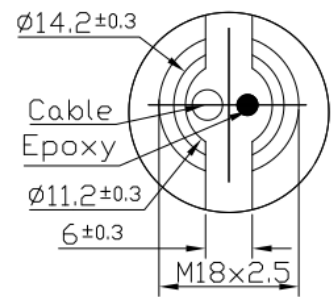

	Name	Material	Finish	QTY
1	Housing	PC	Black	1
2	Closed Cell Foam	CR 4305	Black	1
3	3M Double Adhesive	3M 9448 WC	White Liner	1
4	M18 Inner Nut	Steel Carbon	Ni Plated	1
5	Outer Nut Cover	ABS	Black	1
6	Metal Base	Zinc Alloy	Ni Plated	1
7	Heat Shrink Tube	PE	Black	1
8	Rubber Stopper	Silicon Rubber	Black	1
9	433MHz Label	Coated Paper	Khaki	1

	Name	Spec	Finish	QTY
XX	Cable Length	3000±30mm		1
YY	Cable Type	NFC200	Black	1
ZZ	Connector Type	SMA(M) ST	Gold	1

6. INSTALLATION

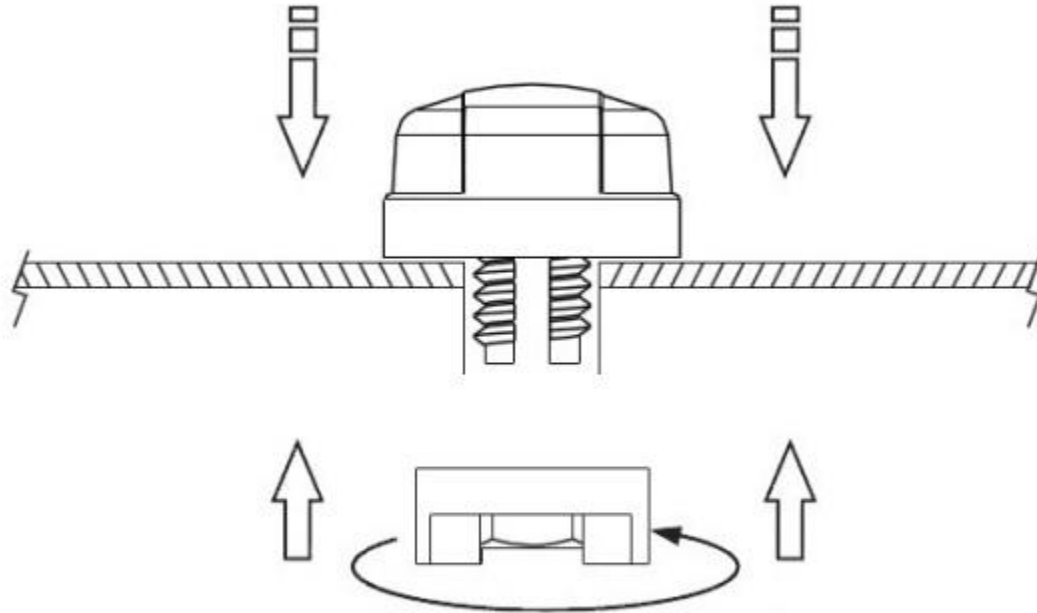

Recommended torque for Mounting is 24.5N·m
Maximum torque for mounting is 29.4N·m

7. PACKAGING

1 pcs IS.01.B.305111 per PE Bag
 Bag Dimensions - 280 x 180 mm
 Weight - 214g

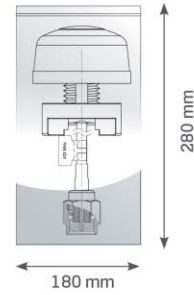

10 pcs IS.01.B.305111 per PE Large Bag
 Bag Dimensions - 520x 360mm
 Weight - 2.2kg

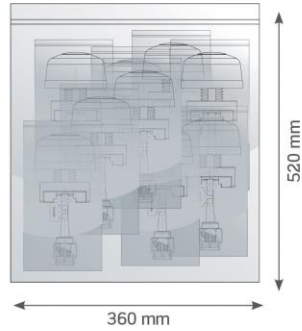

50 pcs IS.01.B.305111 per carton
 Carton - 430 x 380 x 280mm
 Weight - 11.3Kg

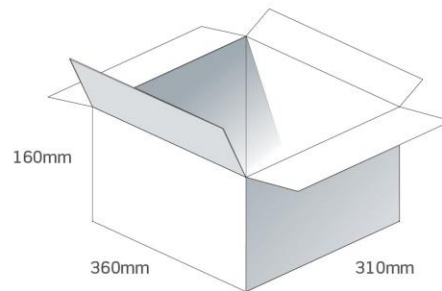

Pallet Dimensions 120x 100 x 132cm
 24 Cartons per Pallet
 6 Cartons per layer
 4 Layers

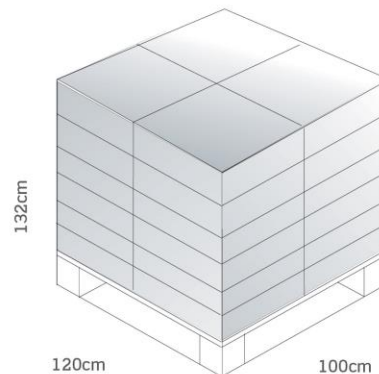

Taoglas makes no warranties based on the accuracy or completeness of the contents of this document and reserves the right to make changes to specifications and product descriptions at any time without notice. Taoglas reserves all rights to this document and the information contained herein.

Reproduction, use or disclosure to third parties without express permission is strictly prohibited.

Copyright © Taoglas Ltd.

