

## SPECIFICATION

- Part No. : **MA104.C.AB.015**
- Product Name : MA104 GPS/GALILEO/Cellular Combination Hercules Screw-mount [Permanent mount]
- Feature : Low profile - Height 29 mm and Diameter 49mm  
Heavy duty screw mount  
UV and vandal resistant PC housing  
Cellular -Penta Band Antenna  
850/900/1800/1900/2100/1575.42 MHz  
GSM/GPRS/CDMA/EVDO/UMTS/HSPA/WCDMA  
GPS/GALILEO - Two Stage 28dB+ LNA  
IP67 & IP69K compliance  
Standard is 3 metres RG174 SMA(M)  
Cables and connectors are fully customizable  
**RoHS Compliant**



## 1. Introduction

The MA.104.C GPS/GALILEO/Cellular Combination Hercules Antenna is a combination high performance GPS/GALILEO and penta-band cellular antenna solution for reliable asset tracking and remote monitoring. Durable UV and robust PC housing is resistant to vandalism and direct attack. At only 29 mm height it complies with the latest EU height restrictions directives for roof-mounted objects, with a diameter of 49 mm.

It is designed to not catch on tree-branches.

The Hercules can be mounted on metal or non-metal structures as it has a metal ground-plane base integrated inside.

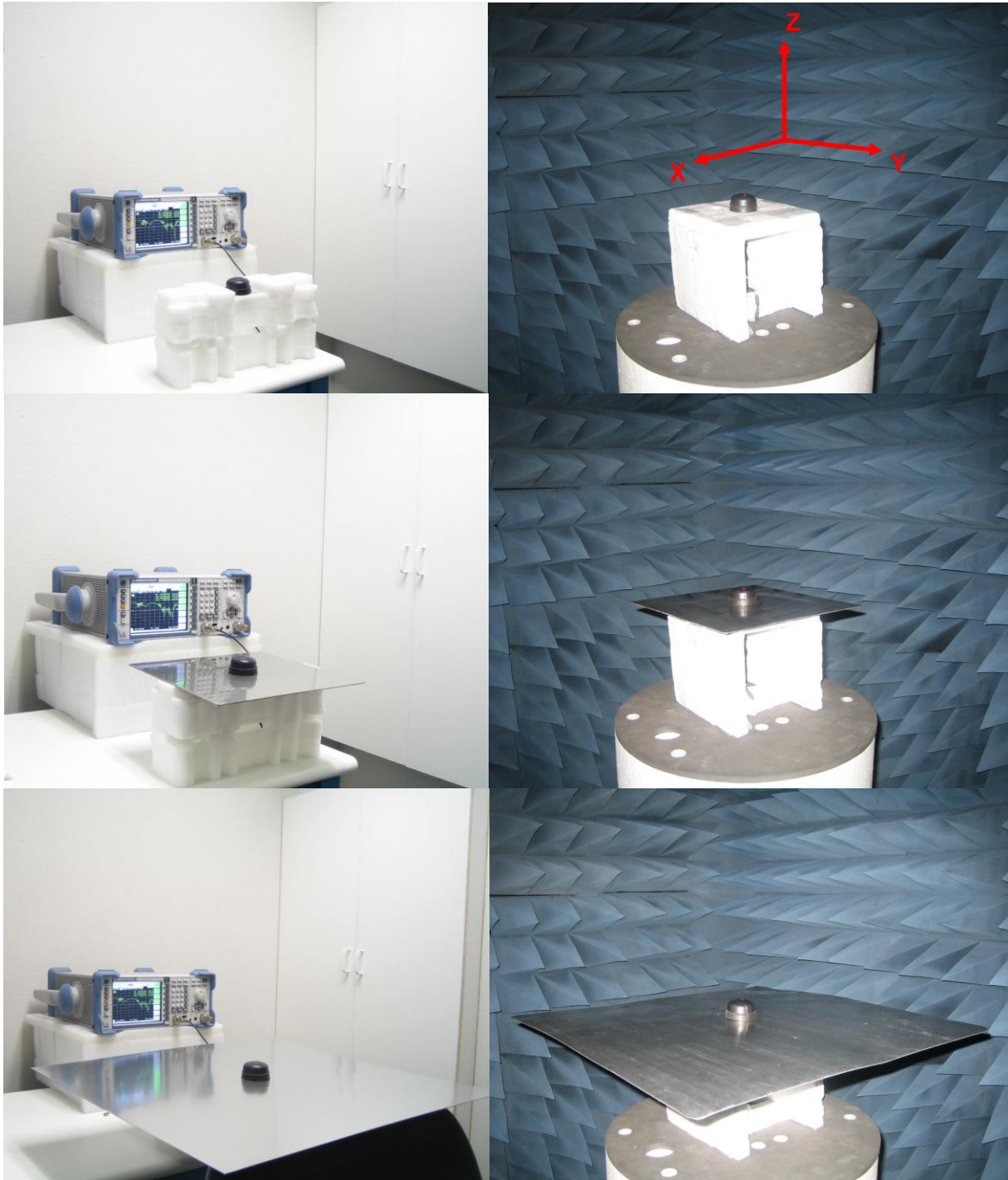
## 2. Specification

ELECTRICAL CELLULAR						
Standard		AMPS	GSM	PCS	DCS	3G
Band (MHz)		850	900	1900	1800	2100
Frequency (MHz)		824-896	880-960	1850-1990	1710-1880	1920 – 2170
Return Loss (dB)						
Cable length (meter)	0.3	-6.5	-6.0	-7	-8	-5
	1.0	-9.5	-8	-17	-16	-15
	2.0	-10	-9	-20	-21	-18
	3.0	-13	-11	-21	-21	-19
	5.0	-14	-14	-25	-25	-23
Efficiency (%)						
Cable length (meter)	0.3	38	54	58	54	50
	1.0	31	35	36	42	31
	2.0	23	20	23	32	21
	3.0	25	29	23	22	18
	5.0	11	11.5	12	11	11
Peak Gain (dBi)						
Cable length (meter)	0.3	2.0	3.3	4.0	3.6	3.0
	1.0	1.2	1.3	2	1.8	1.2
	2.0	0.5	-0.35	0	1.5	-0.1
	3.0	0.1	1.6	0.6	0.1	-0.9
	5.0	-2.5	-2.4	-2.3	-3.0	-2.0
Polarization		Linear				
Impedance		50 Ohms				
Input Power		10 Watts max.				
VSWR		<3.5.0:1				

ELECTRICAL GPS/GALILEO			
Frequency	1575.42MHz $\pm$ 1.023MHz		
Impedance	50 ohm		
VSWR	2.0 Max		
GPS/GALILEO Patch Gain	2.0dB Passive Gain @ Zenith -1.0dBi Gain @ 10 degrees elevation		
Axial ratio	3.0 dB max		
Polarization	RHCP		
Out Band Rejection	fo = 1575.42MHz fo $\pm$ 30 MHz 5dB Min. fo $\pm$ 50 MHz 20dB Min. fo $\pm$ 100 MHz 25dB Min.		
Input Voltage	Min:1.8V	Typ. 3.0V	Max: 5.5V
Total Gain @ Zenith	25dBic	30dBic	32dBic
Current Consumption	6mA	12mA	30mA
Noise Figure	2.7dB	3.0dB	3.7dB
MECHANICAL			
Dimensions	Height 29mm x Diameter 49mm		
Casing	UV resistant PC		
Base and thread	Nickel plated steel		
Thread diameter	18mm		
Weather proof gasket	CR4305 foam with 3M9448B double-side adhesive		
Cable pull	8 Kgf		
Recommended Mounting Torque	24.5N·m		
Max Mounting Torque	29.4N·m		
Weight	200g		
ENVIRONMENTAL			
Waterproof	IP-67 & IP-69K		
Corrosion	5% NaCl for 48hrs - Nickel plated steel base and thread		
Temperature Range	-40°C to +85°C		
Thermal Shock	100 cycles -40°C to +80°C		
Humidity	Non-condensing 65°C 95% RH		
Shock (drop test)	1m drop on concrete 6 axes		

\*Note: The return loss, efficiency and gain measurements in the above table, were taken for the antenna mounted on a 30x30 cm metal plate. For a specific case performance refers to the below plots.

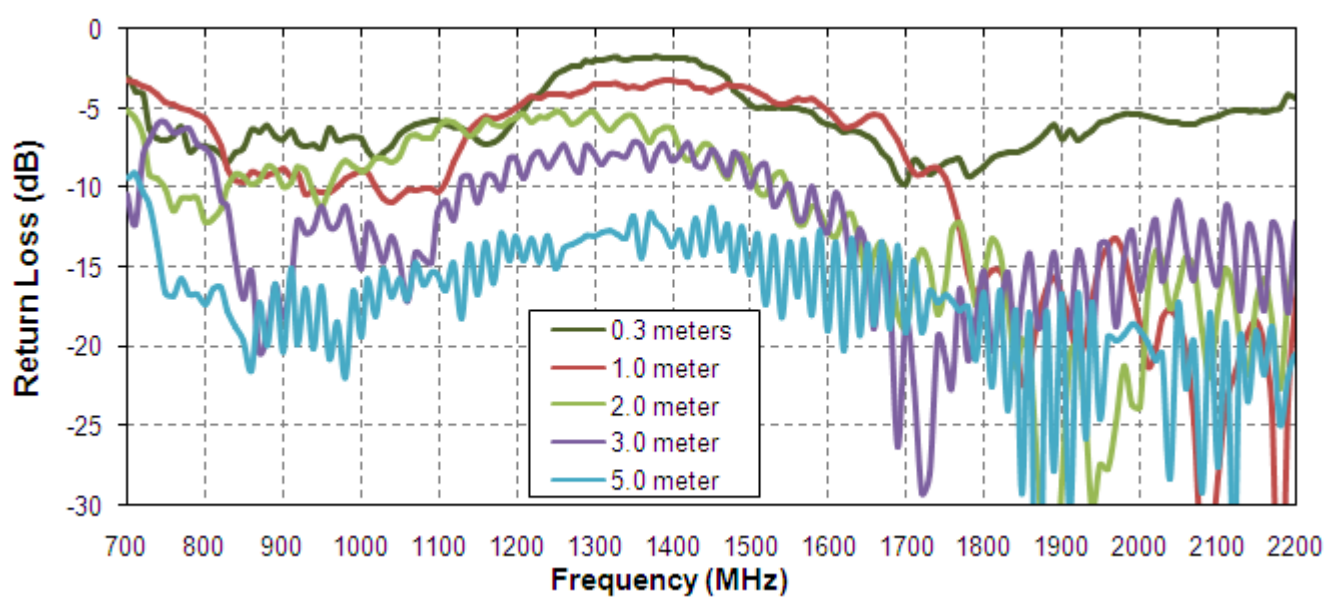
### 3. Test Setup



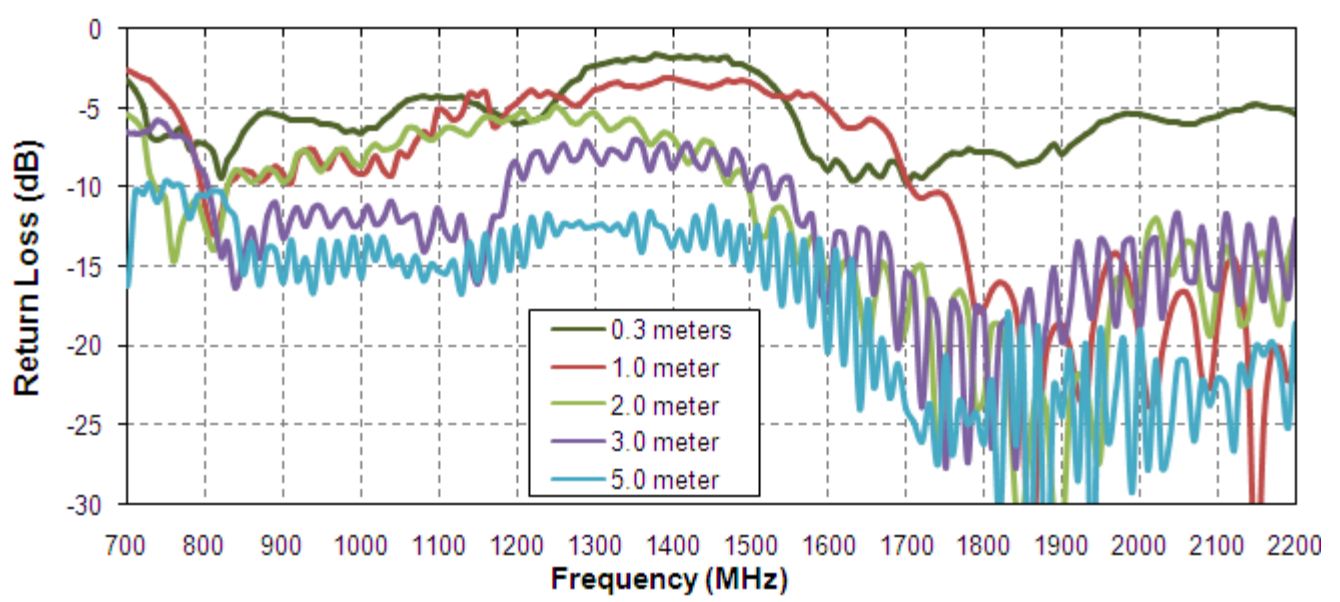
**Figure 1.** MA104 Antenna test set up in free space, 30x30 cm metal plate and 60x60 cm metal plate, R&SZVL6 VNA (left) and R&S4100 CTIA 3D Chamber (Right).

## 4. Antenna Parameters

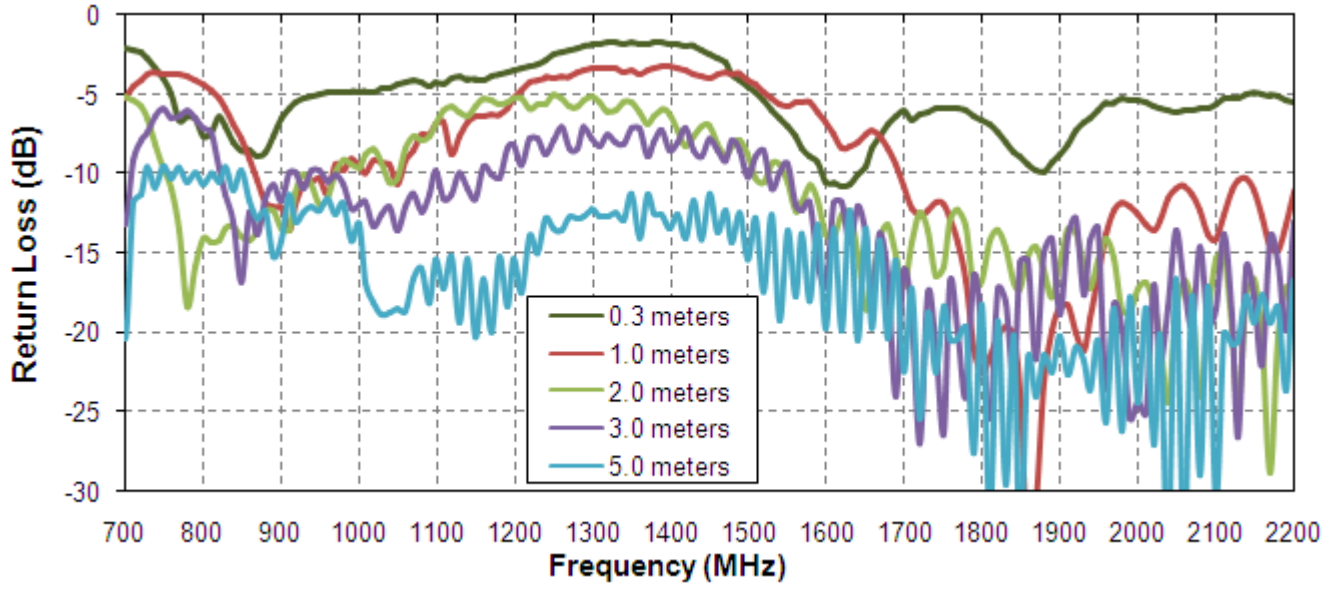
### 4.1 Return Loss



**Figure 2.** Return Loss of the MA104 antenna in free space



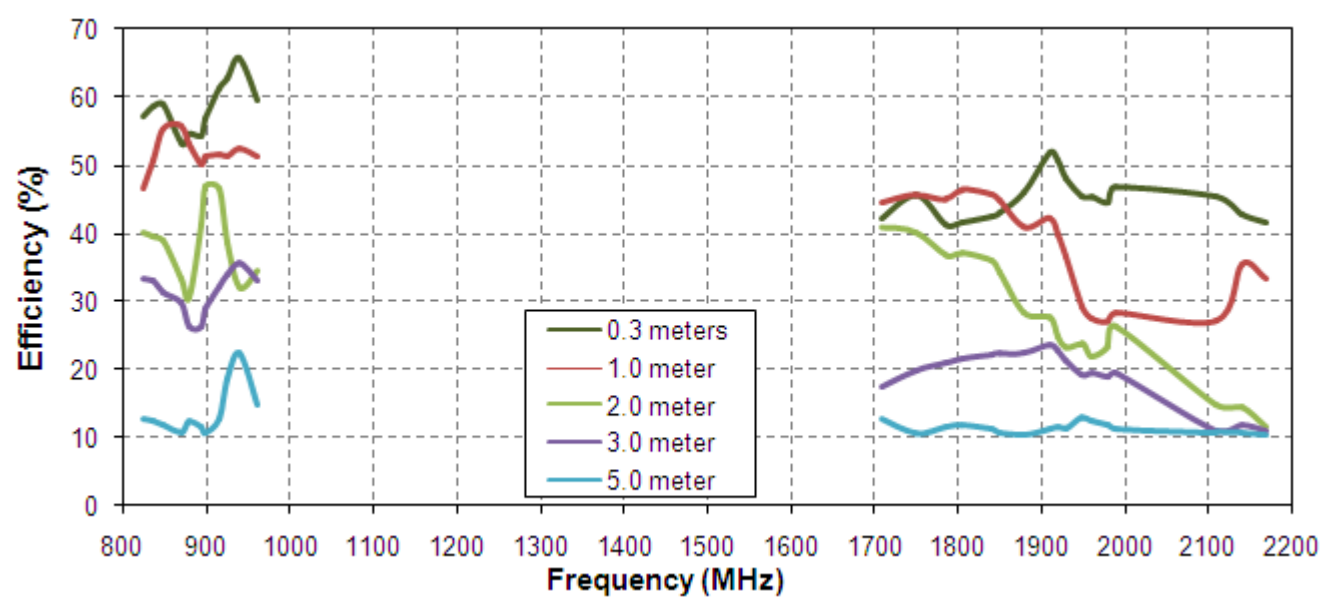
**Figure 3.** Return Loss of the MA104 antenna on 30\*30cm metal plate



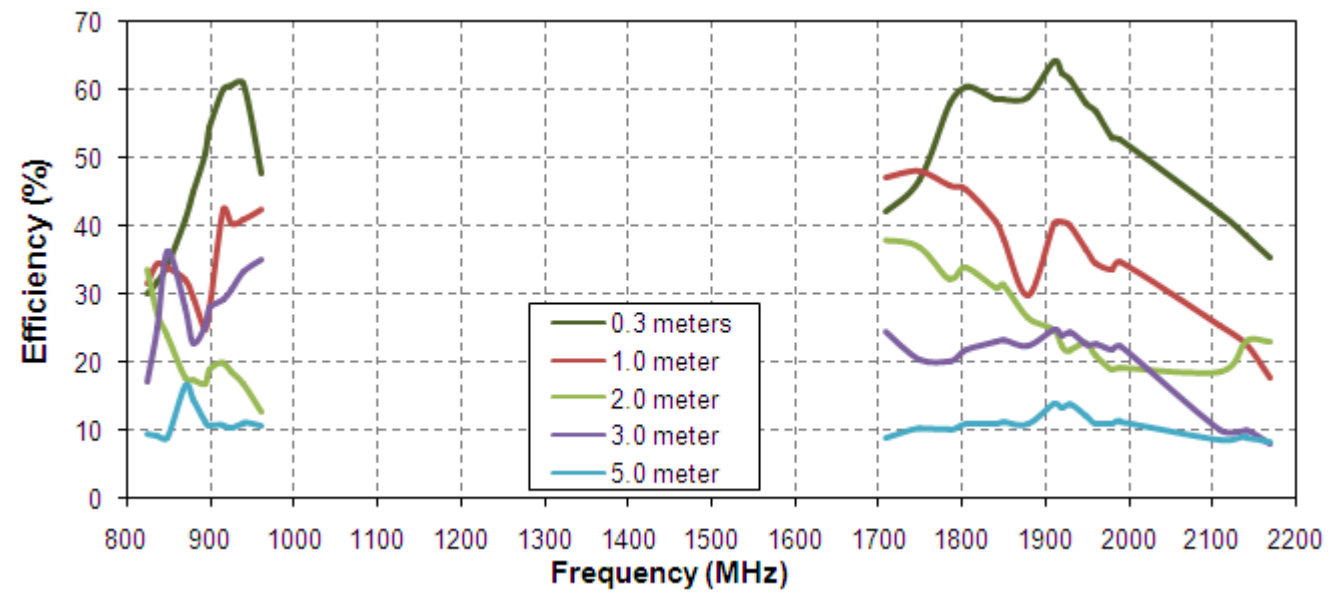
**Figure 4.** Return Loss of the MA104 antenna on 60\*60cm metal plate



## 4.2 Efficiency

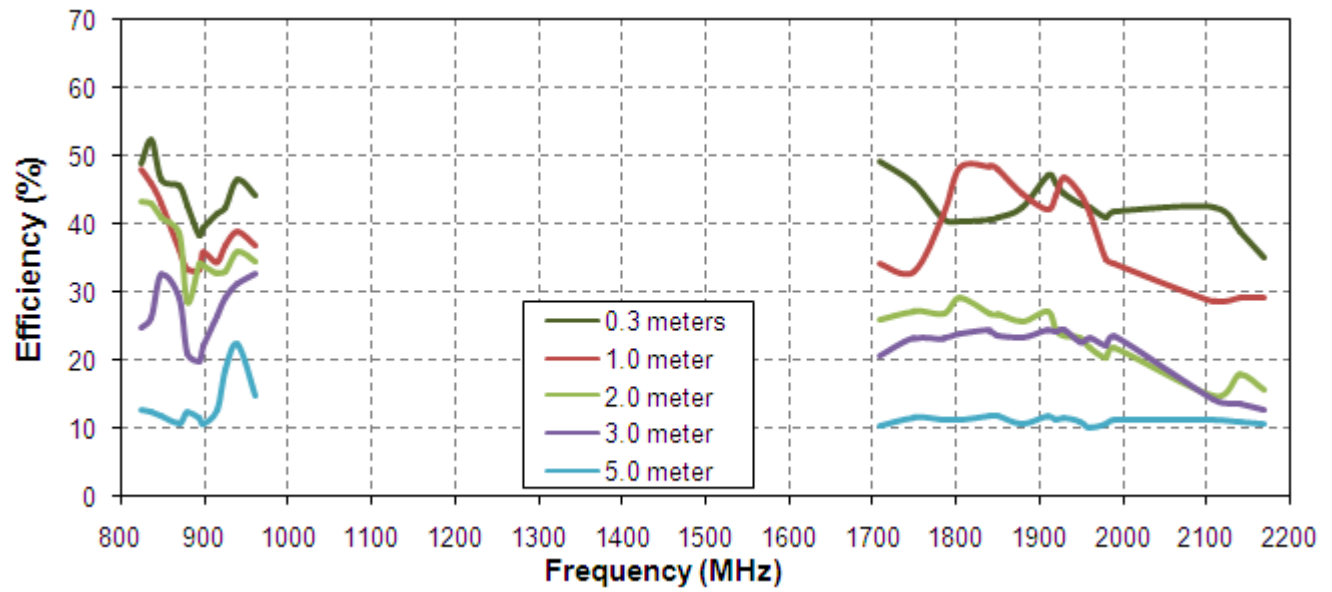


**Figure 5.** Efficiency of the MA104 antenna in free space

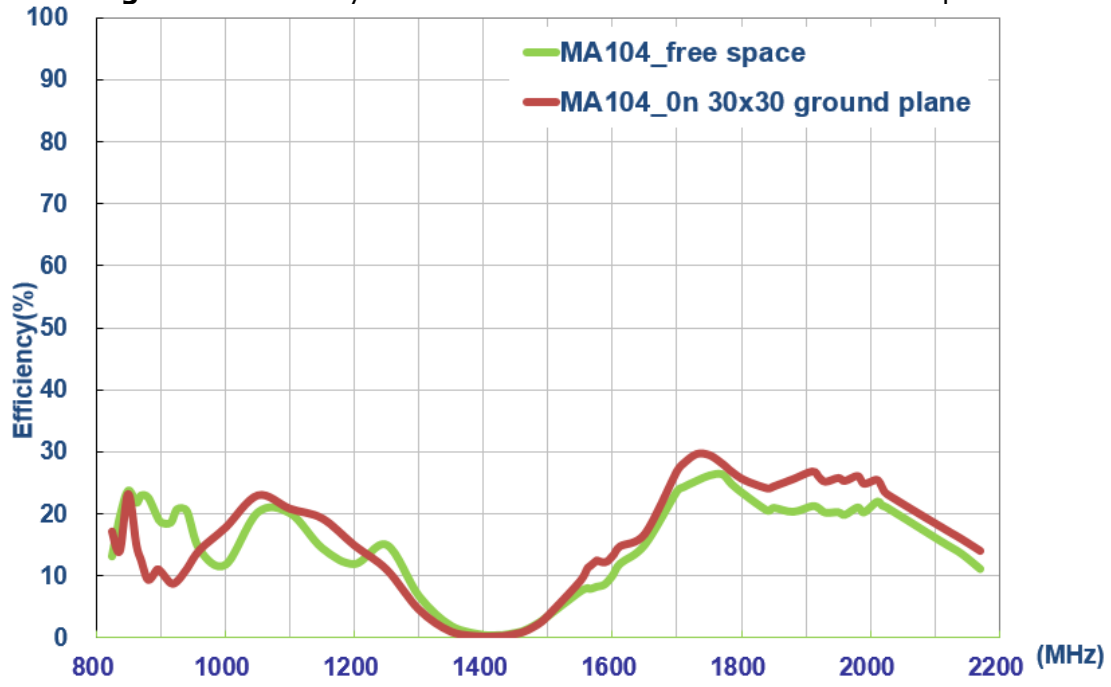


**Figure 6.** Efficiency of the MA104 antenna on 30\*30cm metal plate





**Figure 7.** Efficiency of the MA104 antenna on 60\*60cm metal plate.



**Figure 8.** Efficiency of the MA104 antenna with 960~1700MHz

### 4.3 Peak Gain

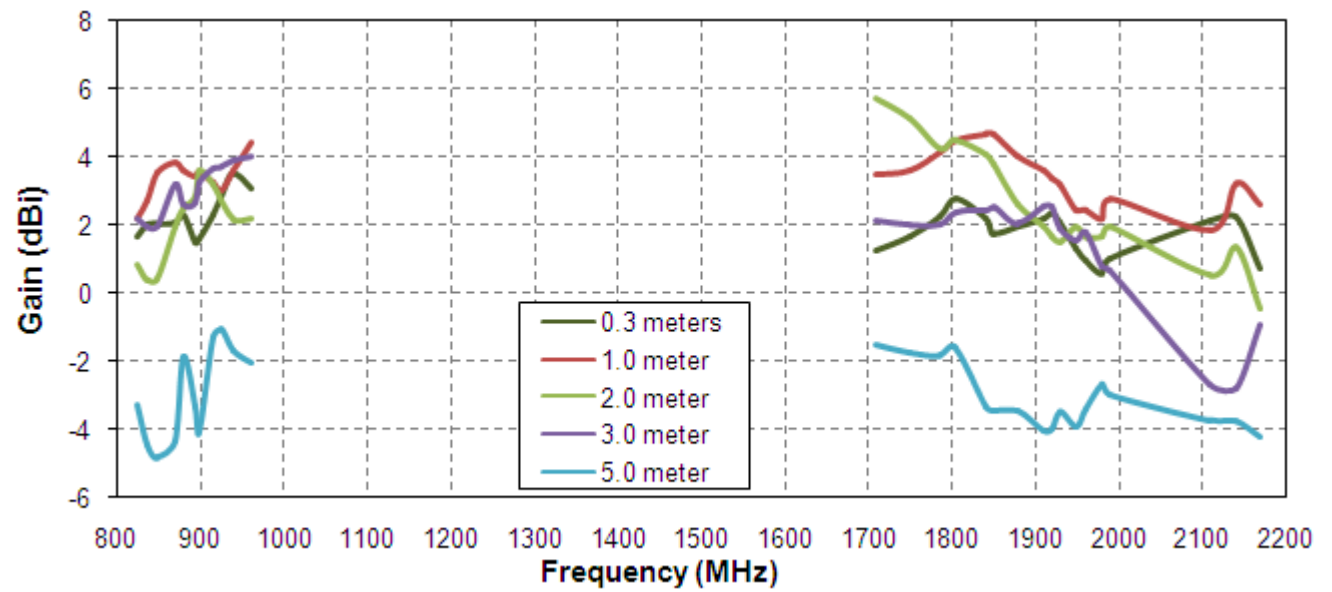


Figure 9. Gain of the MA104 antenna in free space

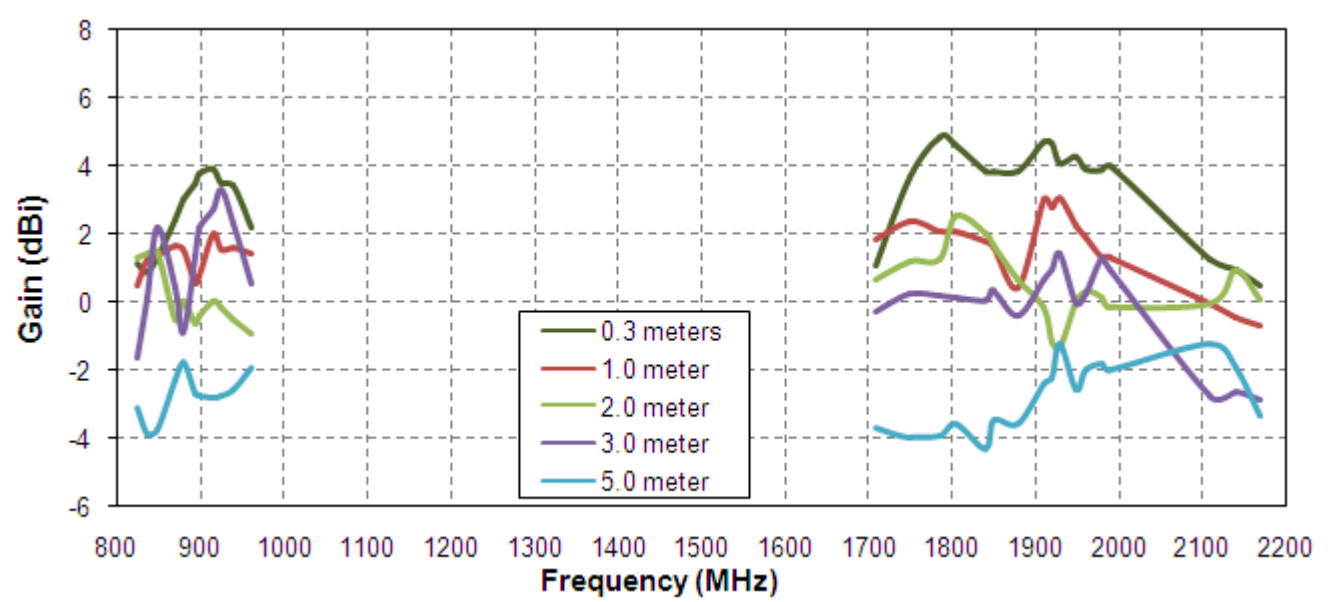
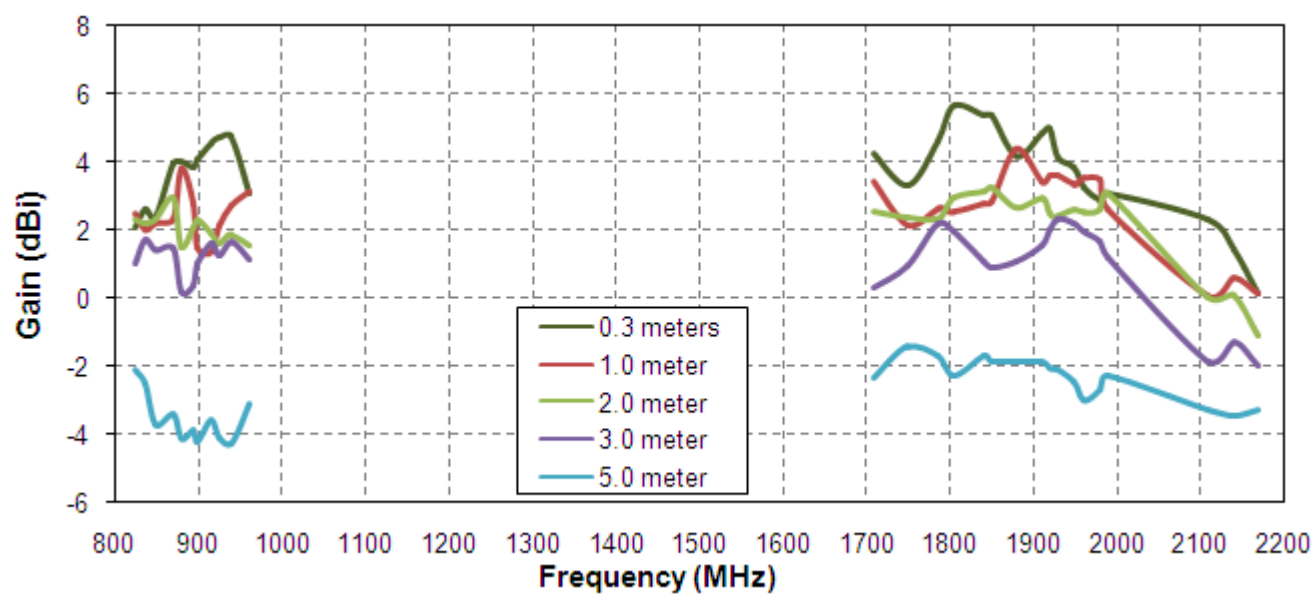
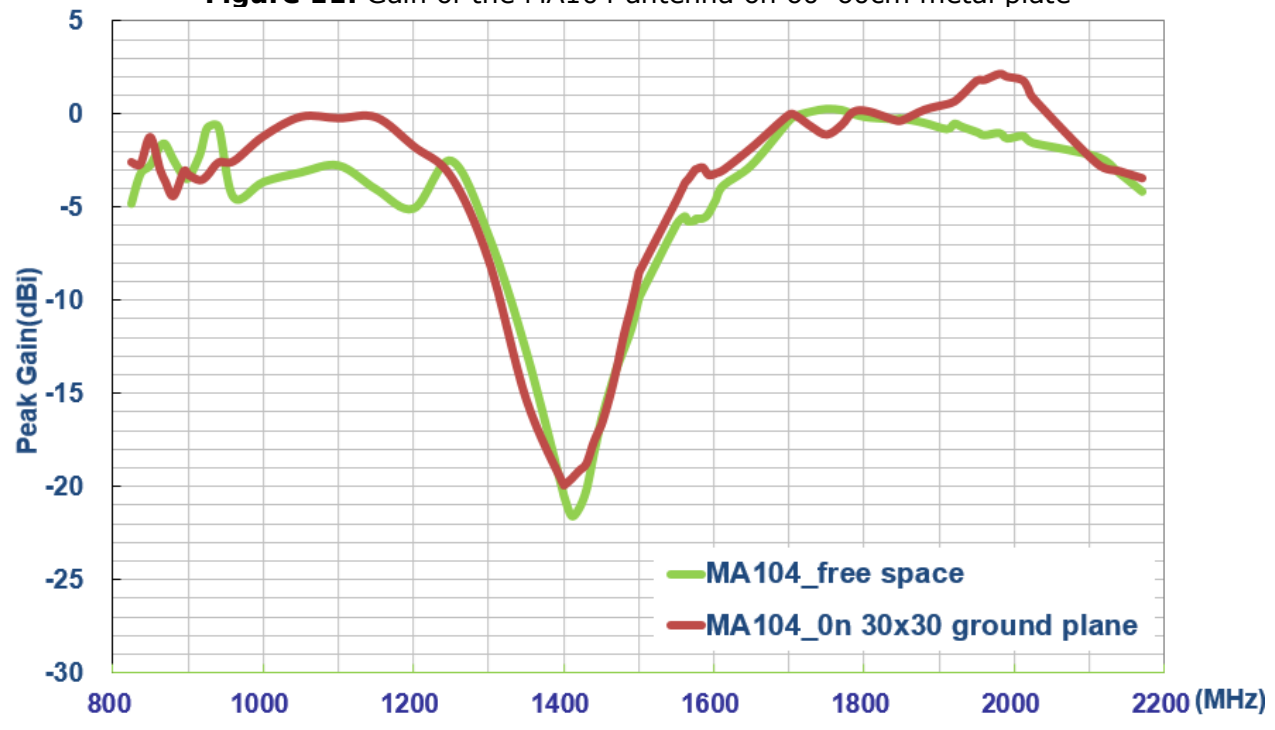


Figure 10. Gain of the MA104 antenna on 30\*30cm metal plate

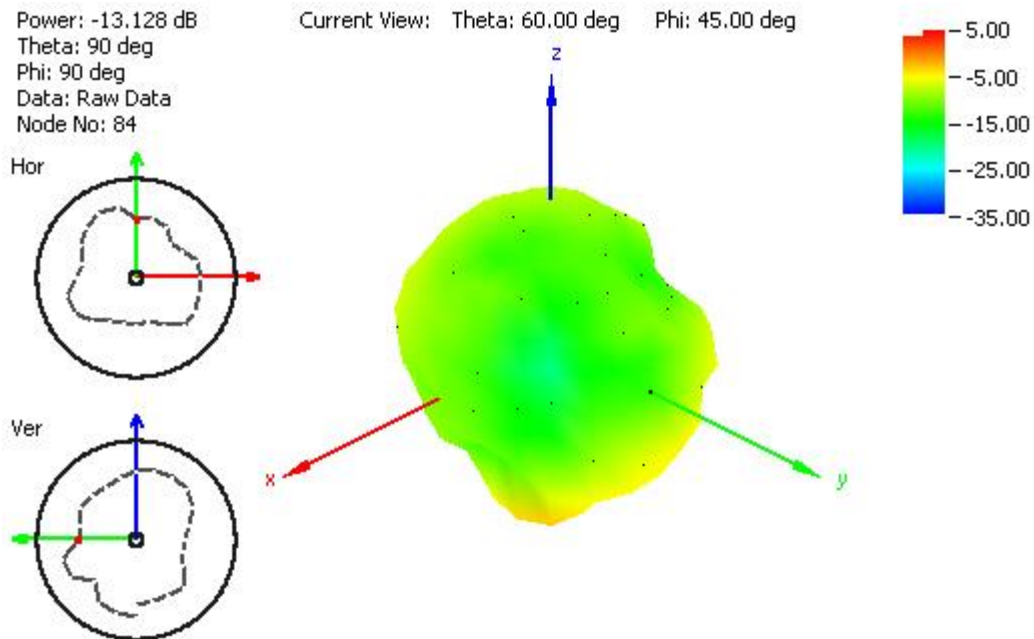


**Figure 11.** Gain of the MA104 antenna on 60\*60cm metal plate

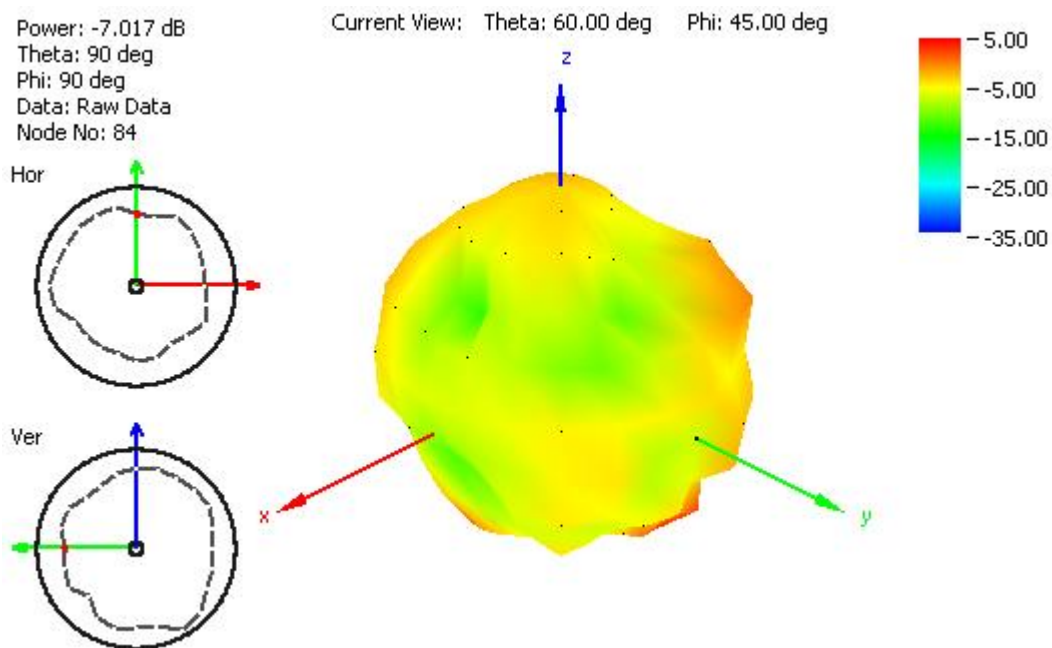


**Figure 12.** Gain of the MA104 antenna from 960~1700MHz

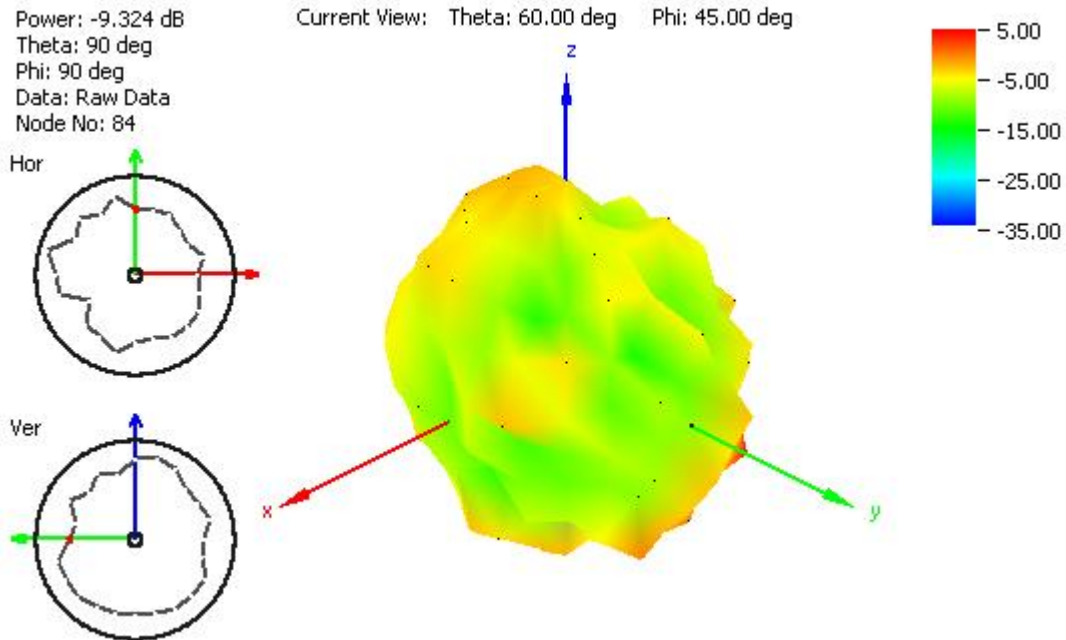
## 4.4 Radiation pattern



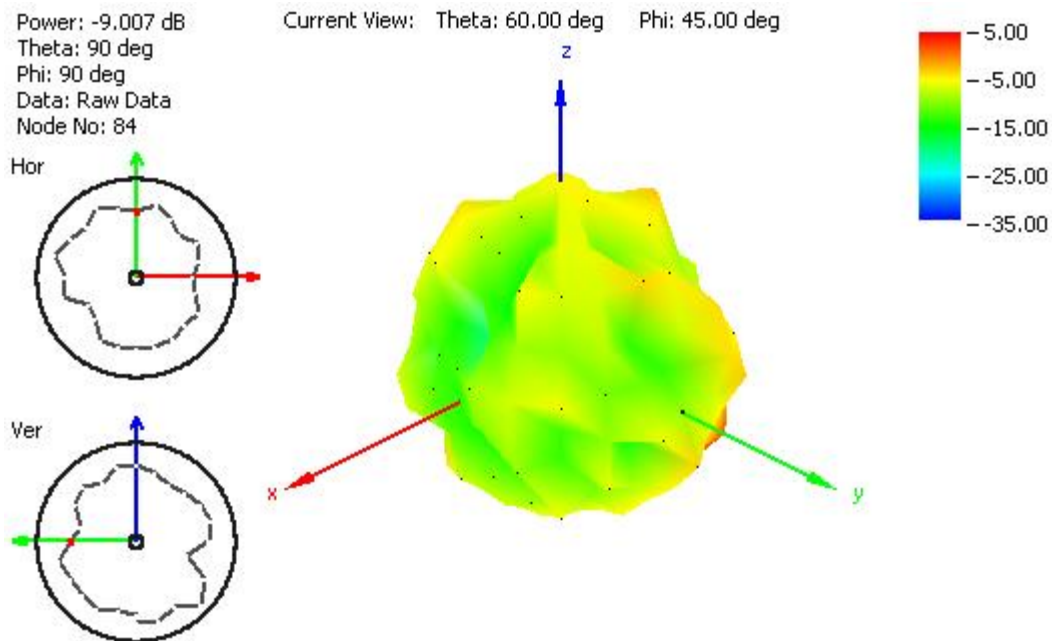
**Figure 13.** Radiation pattern at 849 MHz, Figure 1 as reference (dB), with 2 m RG174 cable and free space



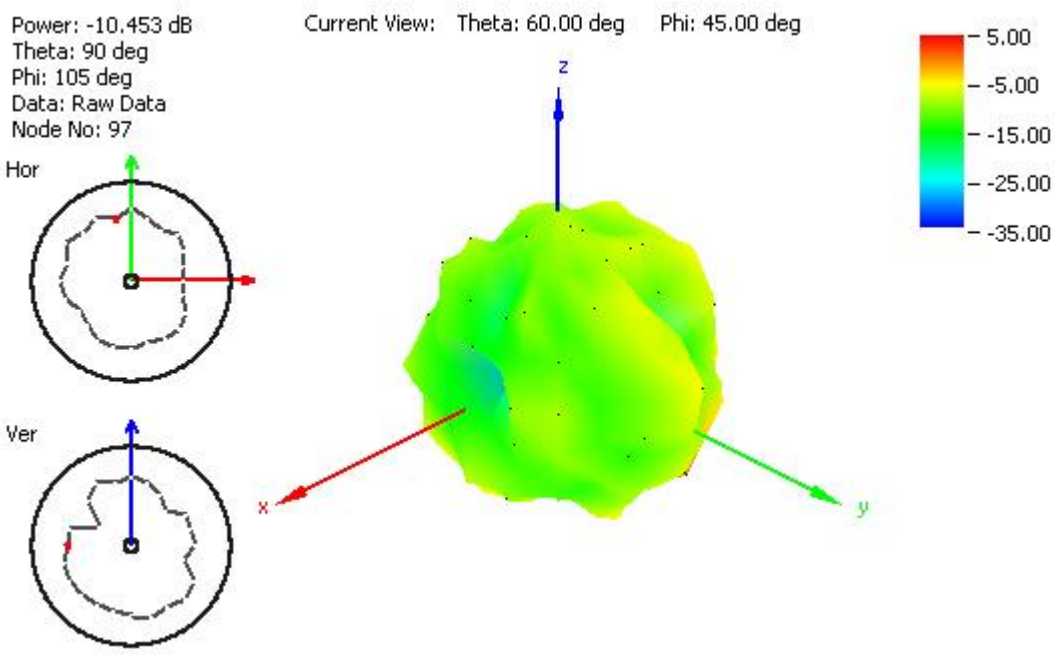
**Figure 14.** Radiation pattern at 915 MHz, Figure 1 as reference (dB), with 2 m RG174 cable and free space



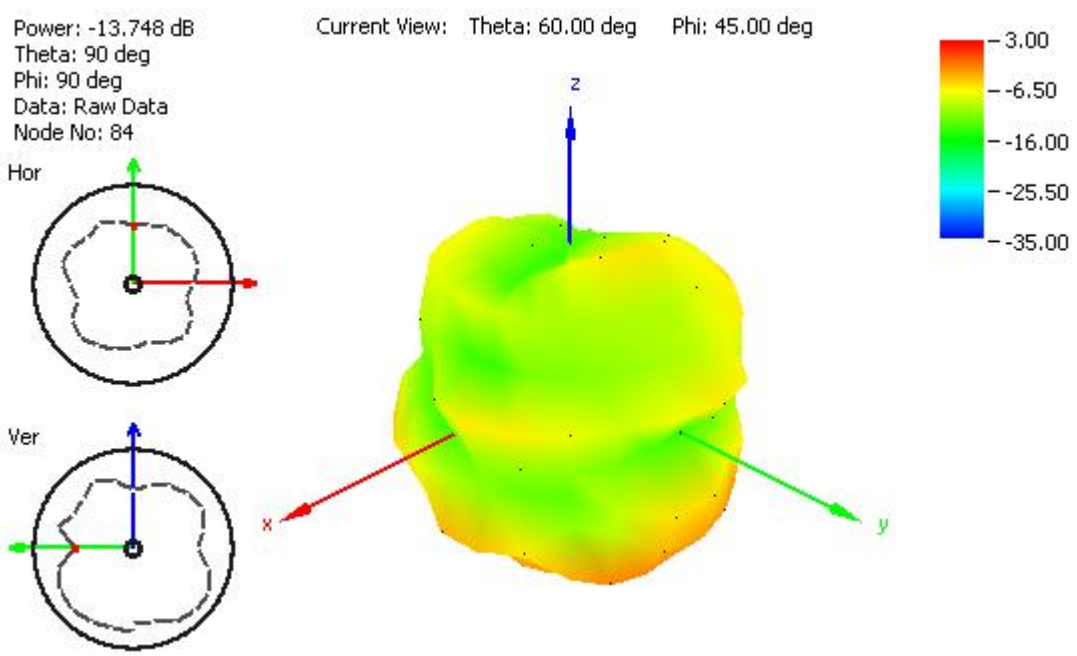
**Figure 15.** Radiation pattern at 1805 MHz, Figure 1 as reference (dB), with 2 m RG174 cable and free space



**Figure 16.** Radiation pattern at 1910 MHz, Figure 1 as reference (dB), with 2 m RG174 cable and free space

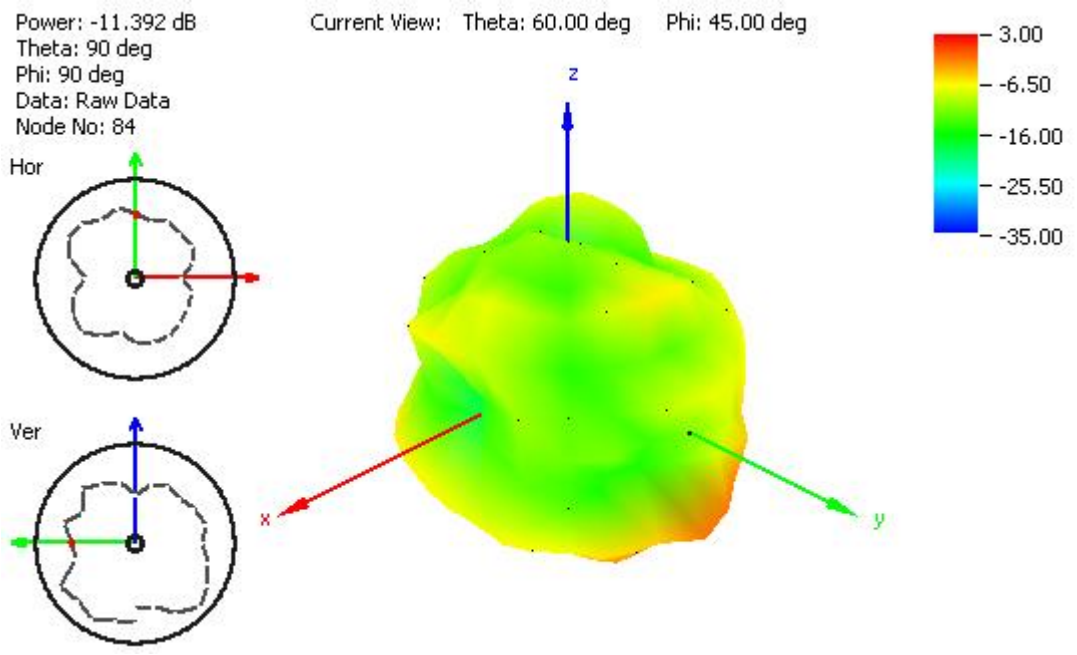


**Figure 17.** Radiation pattern at 2110 MHz, Figure 1 as reference (dB), with 2 m RG174 cable and free space.

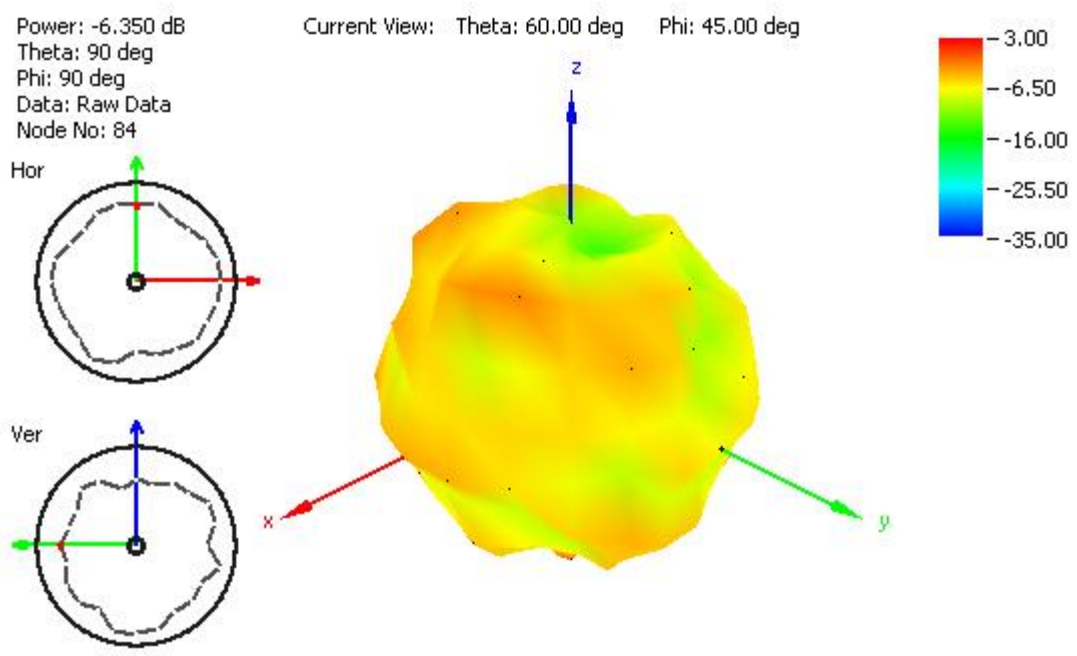


**Figure 18.** Radiation pattern at 849 MHz, Figure 1 as reference (dB), with 2 m RG174 cable and 30x30 cm metal plate



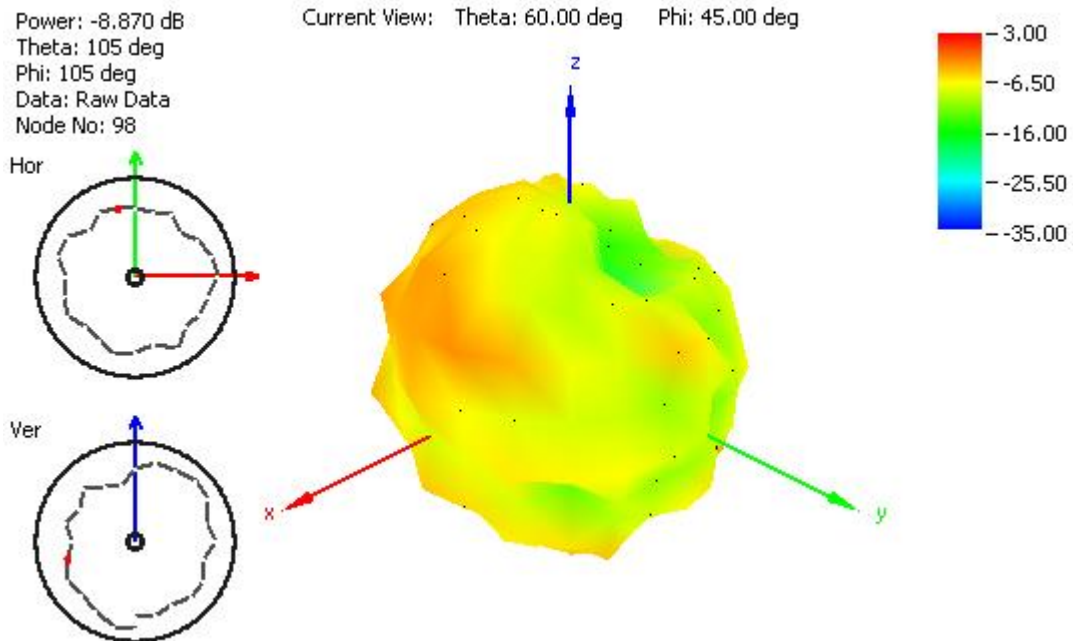


**Figure 19.** Radiation pattern at 915 MHz, Figure 1 as reference (dB), with 2 m RG174 cable and 30x30 cm metal plate

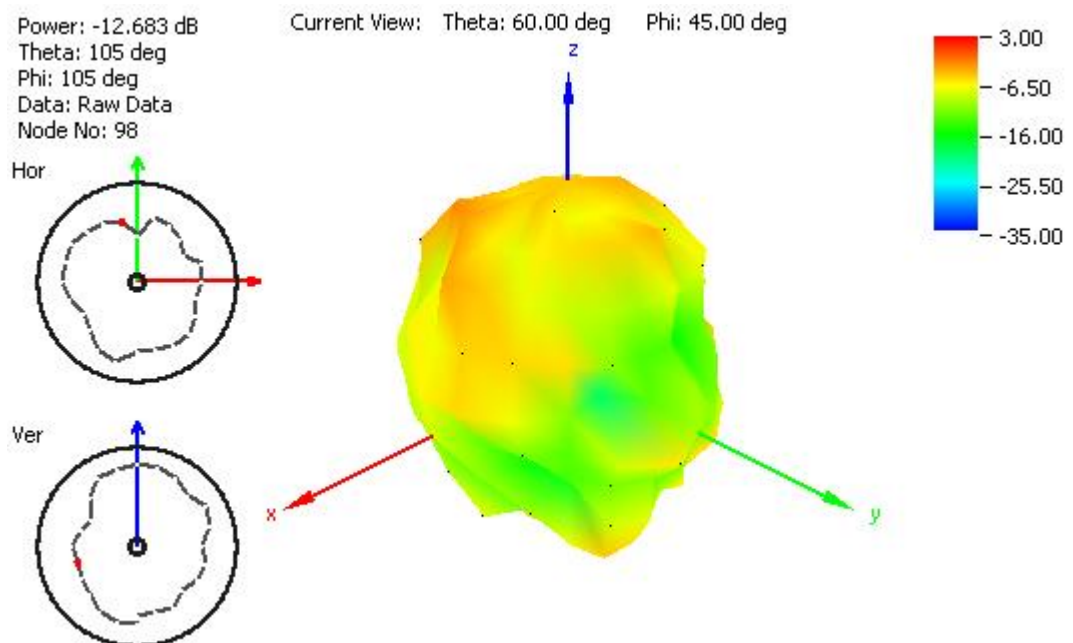


**Figure 20.** Radiation pattern at 1805 MHz, Figure 1 as reference (dB), with 2 m RG174 cable and 30x30 cm metal plate

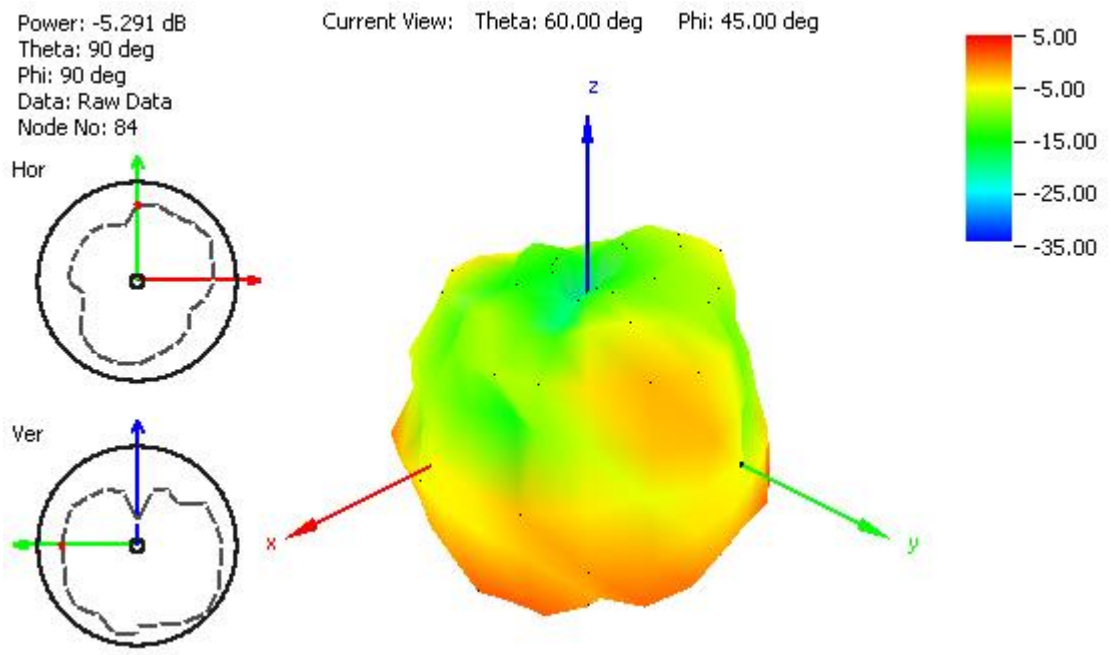




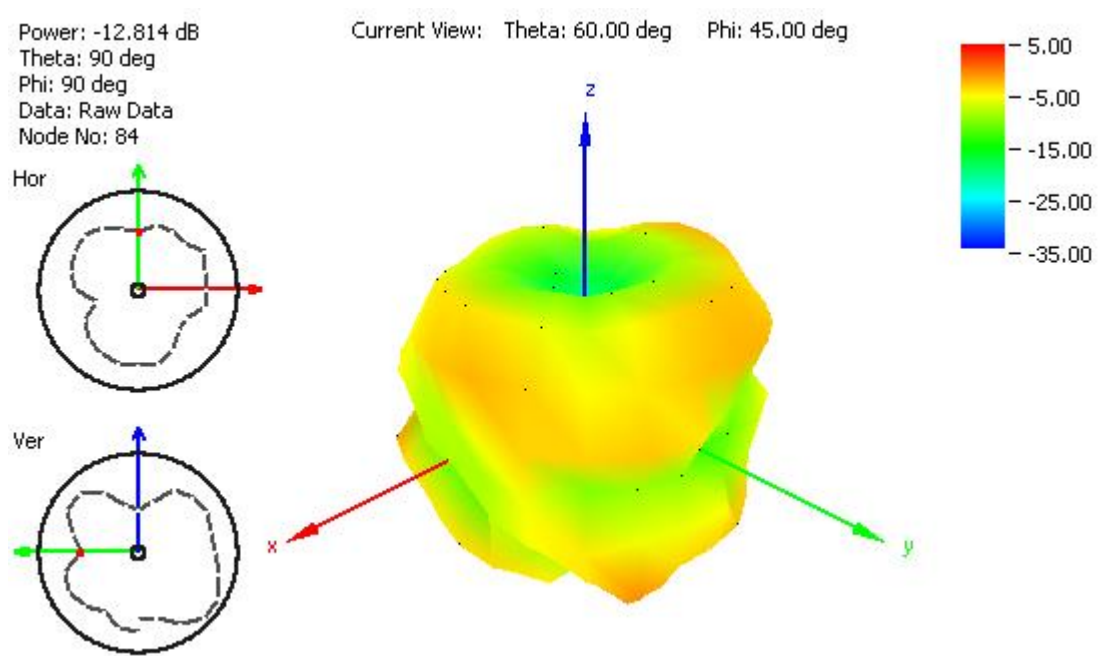
**Figure 21.** Radiation pattern at 1910 MHz, Figure 1 as reference (dB), with 2 m RG174 cable and 30x30 cm metal plate



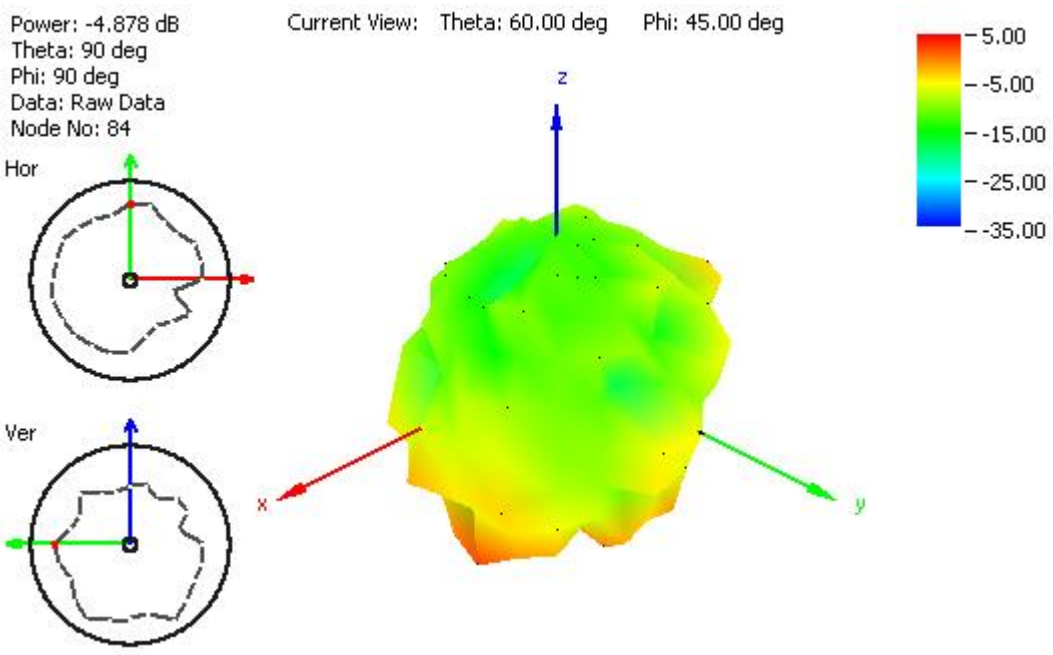
**Figure 22.** Radiation pattern at 2110 MHz, Figure 1 as reference (dB), with 2 m RG174 cable and 30x30 cm metal plate



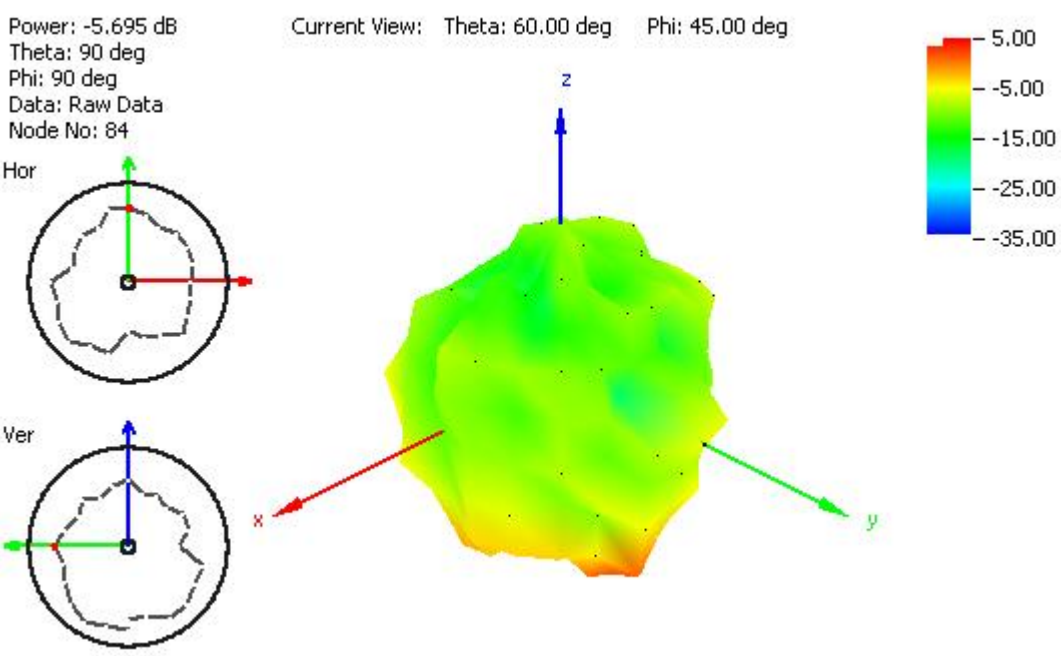
**Figure 23.** Radiation pattern at 849 MHz, Figure 1 as reference (dB), with 2 m RG174 cable and 60x60 cm metal plate



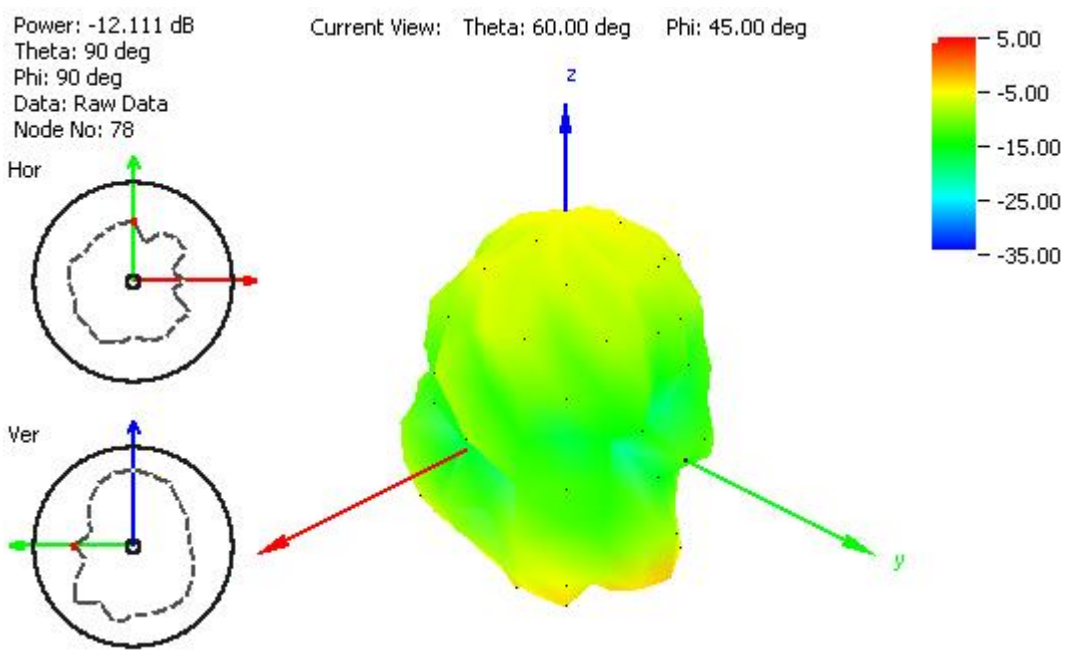
**Figure 24.** Radiation pattern at 915 MHz, Figure 1 as reference (dB), with 2 m RG174 cable and 60x60 cm metal plate



**Figure 25.** Radiation pattern at 1805 MHz, Figure 1 as reference (dB), with 2 m RG174 cable and 60x60 cm metal plate

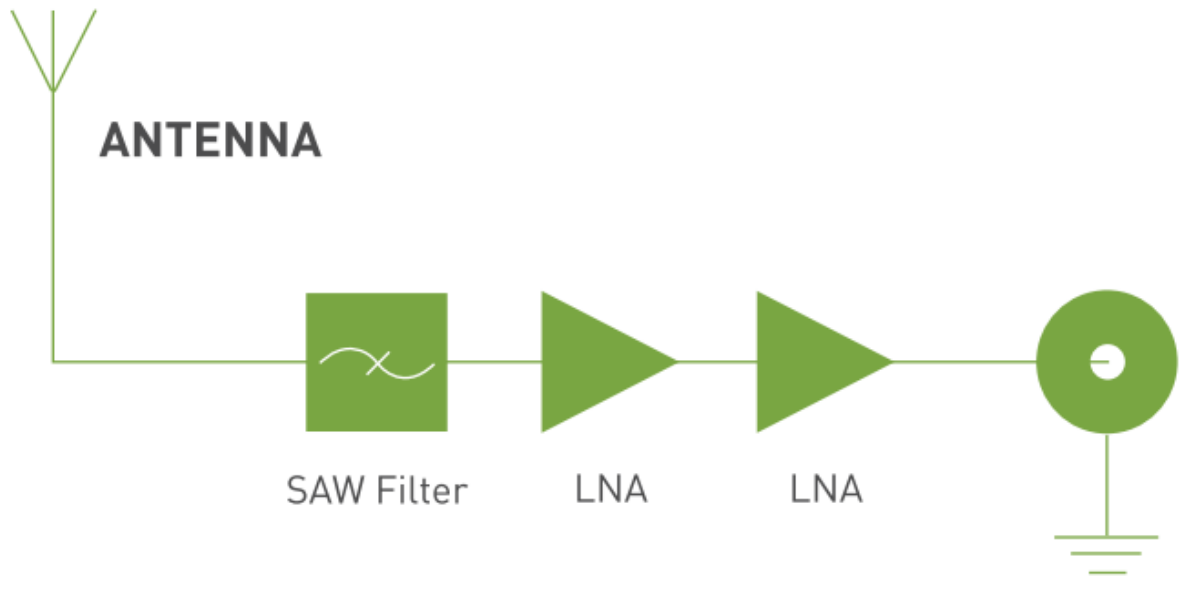


**Figure 26.** Radiation pattern at 1910 MHz, Figure 1 as reference (dB), with 2 m RG174 cable and 60x60 cm metal plate

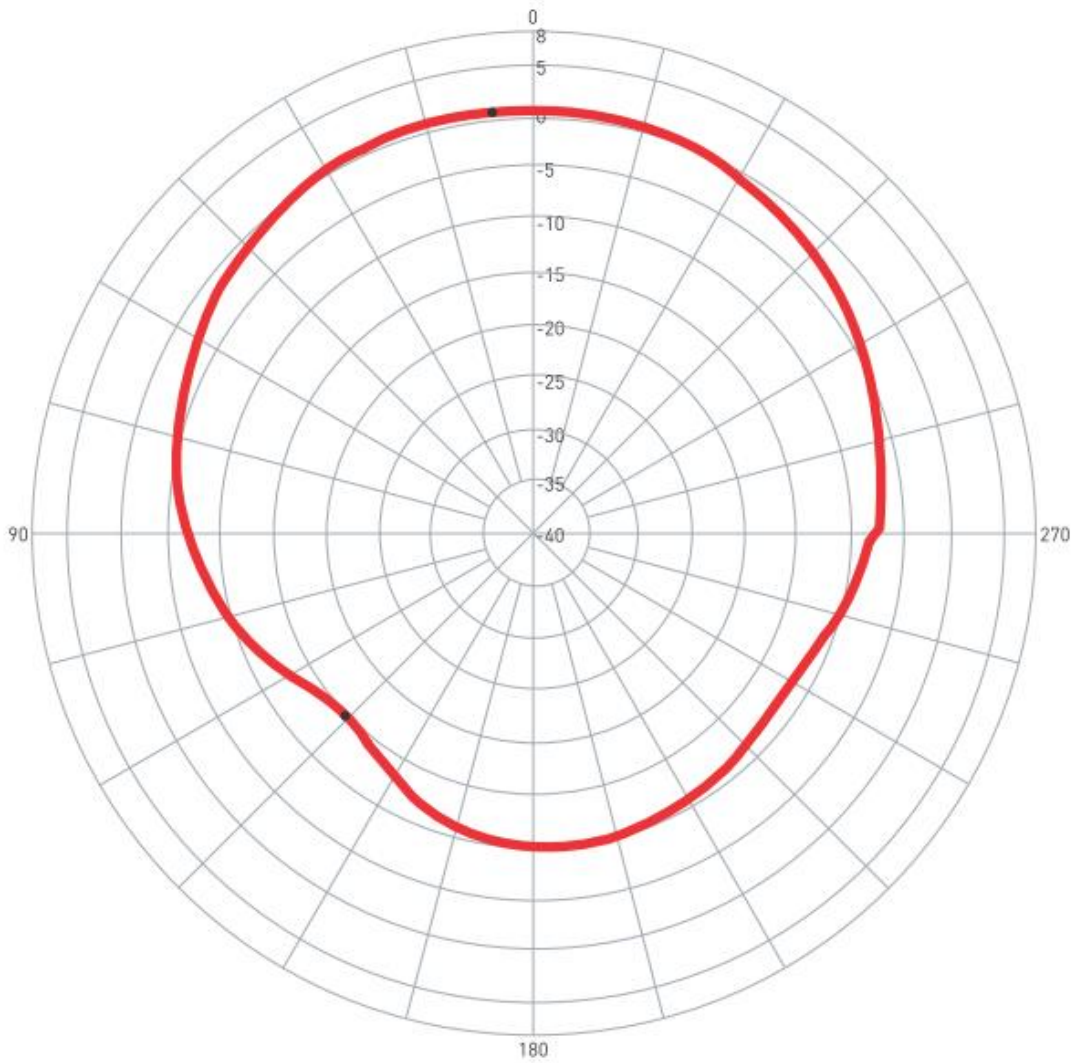


**Figure 27.** Radiation pattern at 2110 MHz, Figure 1 as reference (dB), with 2 m RG174 cable and 60x60 cm metal plate

## 5. System Block Diagram



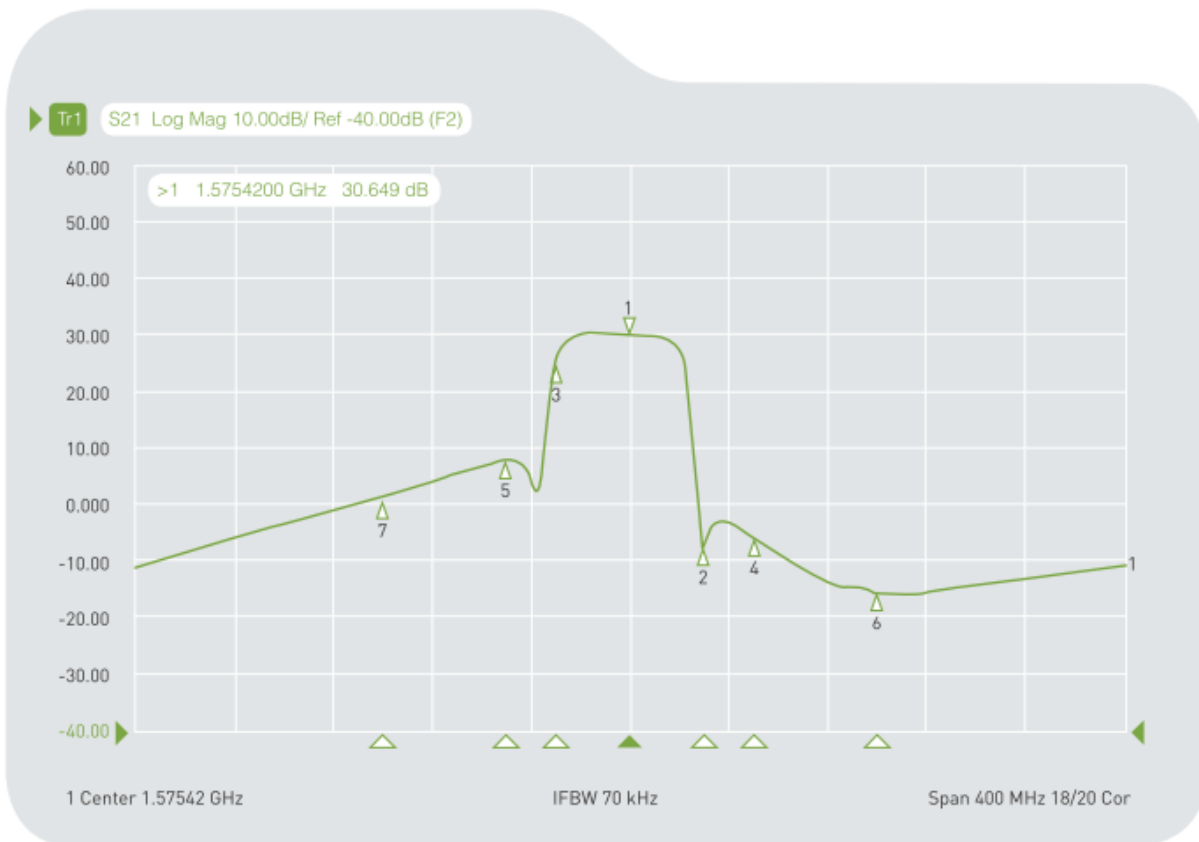
## 6. GPS/GALILEO Patch Radiation Pattern



0 degree is the top of Hercules.

## 7. LNA Properties

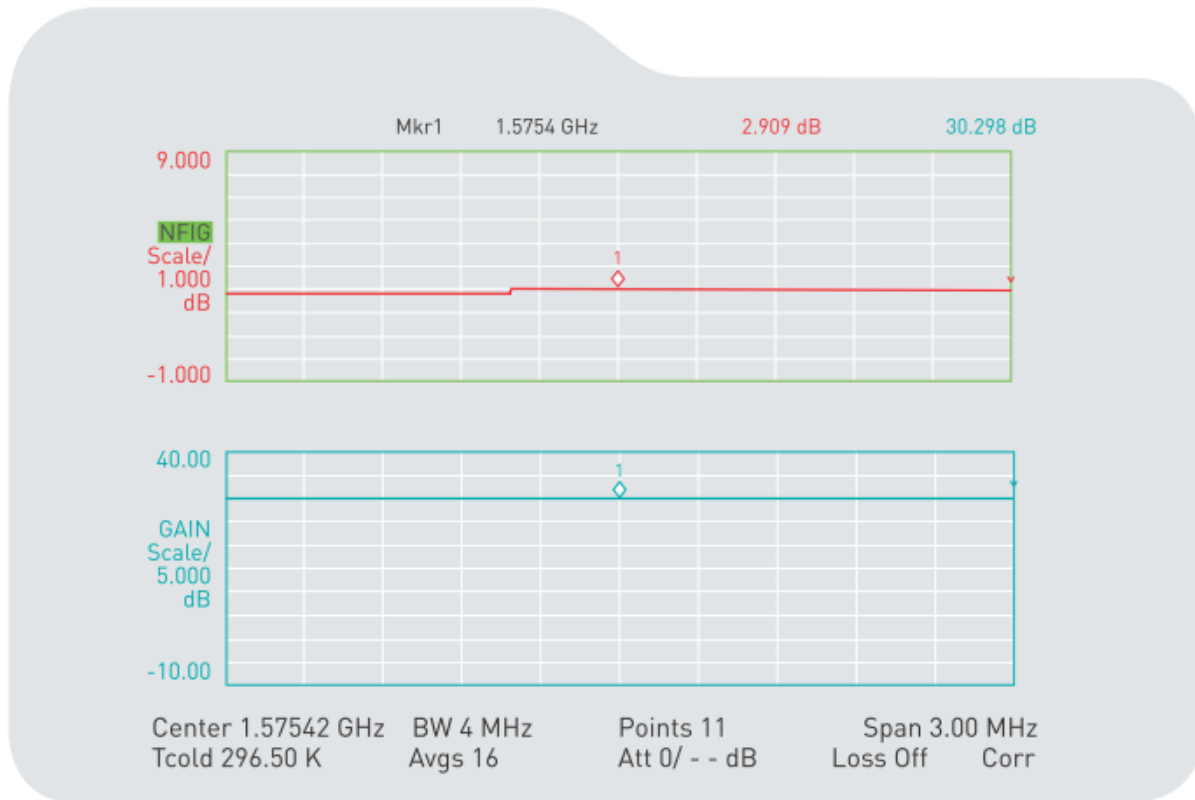
### 7.1 LNA Gain and Out-band Rejection @ 3.0V



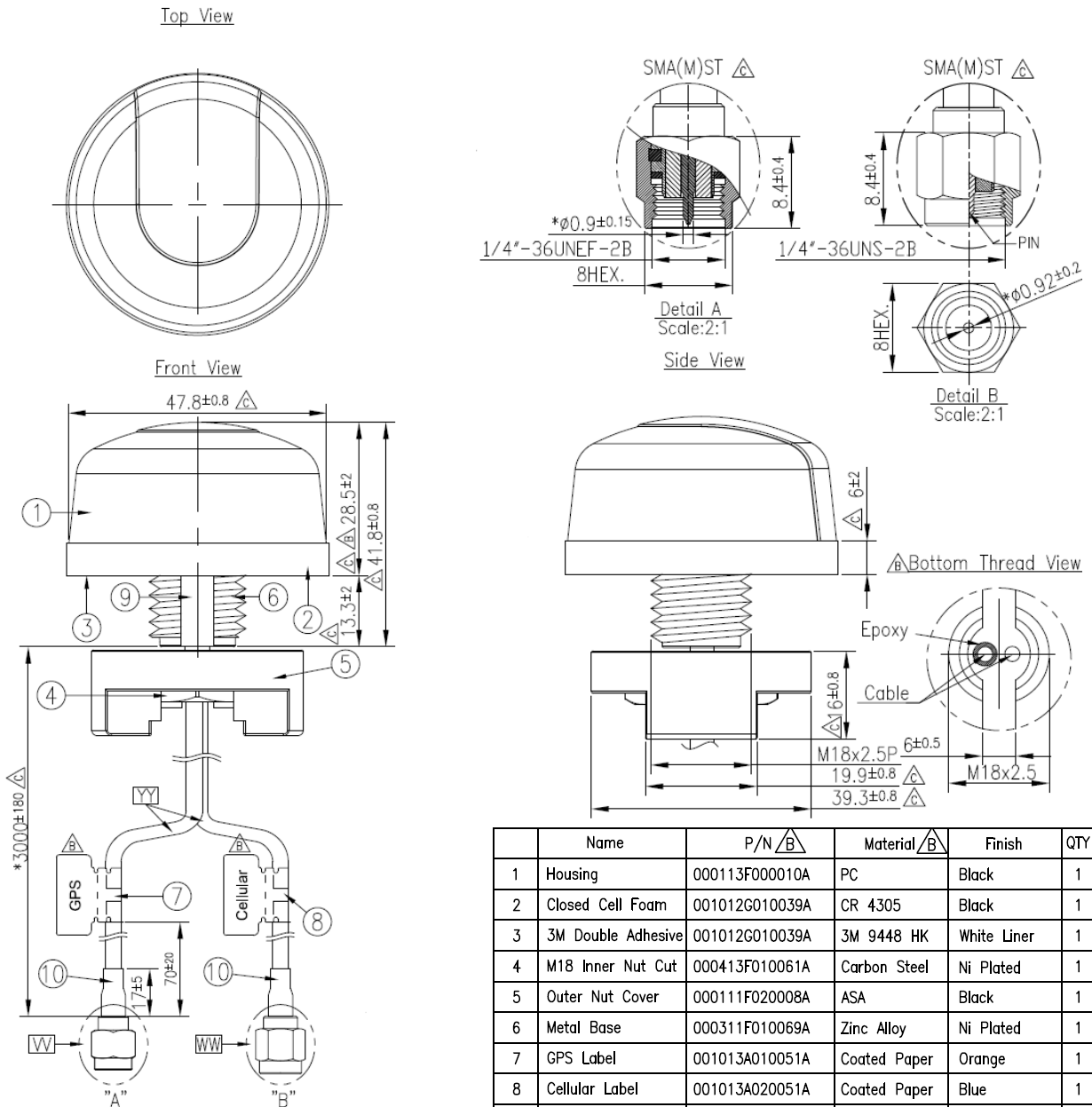
Cg1	Tr1	S21	>1	1.5754200 GHz	30.649 dB
Cg1	Tr1	S21	2	1.6054200 GHz	-6.7098 dB
Cg1	Tr1	S21	3	1.5454200 GHz	24.584 dB
Cg1	Tr1	S21	4	1.6254200 GHz	-5.6354 dB
Cg1	Tr1	S21	5	1.5254200 GHz	8.0734 dB
Cg1	Tr1	S21	6	1.6754200 GHz	-15.436 dB
Cg1	Tr1	S21	7	1.4754200 GHz	-1.5714 dB



## 7.2 Noise Figure



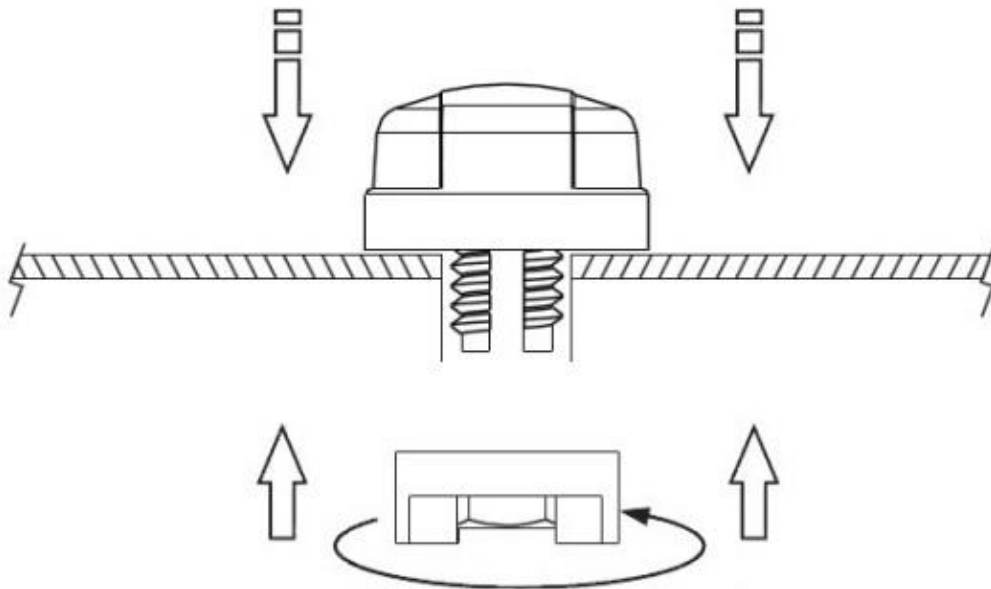
## 8. Drawing(Unit: mm)



	Name	P/N	Material	Finish	QTY
1	Housing	000113F000010A	PC	Black	1
2	Closed Cell Foam	001012G010039A	CR 4305	Black	1
3	3M Double Adhesive	001012G010039A	3M 9448 HK	White Liner	1
4	M18 Inner Nut Cut	000413F010061A	Carbon Steel	Ni Plated	1
5	Outer Nut Cover	000111F020008A	ASA	Black	1
6	Metal Base	000311F010069A	Zinc Alloy	Ni Plated	1
7	GPS Label	001013A010051A	Coated Paper	Orange	1
8	Cellular Label	001013A020051A	Coated Paper	Blue	1
9	Rubber Stopper	000711F040064A	Silicone Rubber	Black	1
10	Heat Shrink Tube	001315C020000A	PE	Black	2

	Name	P/N	Material	Finish	QTY
W	Connector Type	200212G000007C	SMA(M)St	Au Plated	1
WW	Connector Type	200212G000013A	SMA(M)St	Au Plated	1
YY	Cable Type	301315C000000A	RG174	Black	2

## 9. Installation

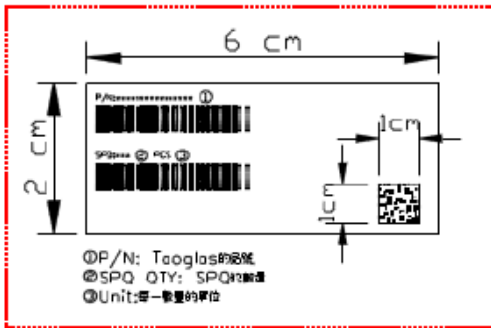


Recommended torque for Mounting is 24.5N·m  
Maximum torque for mounting is 29.4N·m

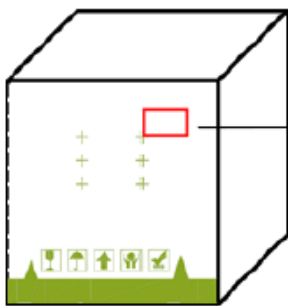
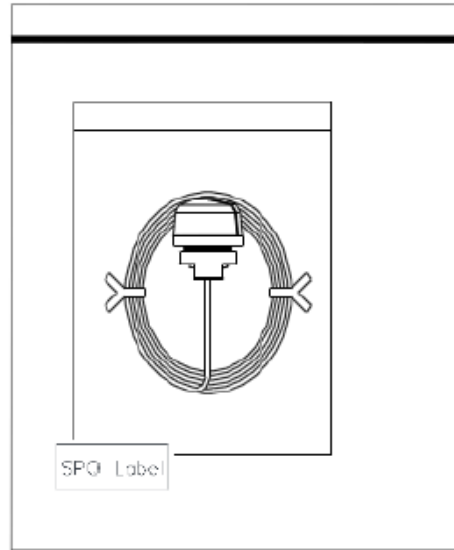


# 10. Packaging

1pcs/PE Bag(160\*300)  
 SPQ-10pcs/PE Bag(280\*450mm)



Label 1



60pcs/Carton  
 (390\*260\*330mm)



Taoglas makes no warranties based on the accuracy or completeness of the contents of this document and reserves the right to make changes to specifications and product descriptions at any time without notice. Taoglas reserves all rights to this document and the information contained herein.

Reproduction, use or disclosure to third parties without express permission is strictly prohibited.

Copyright © Taoglas Ltd.