

SIPMOS® Small-Signal Transistor

BSP 149

- V_{DS} 200 V
- I_D 0.48 A
- $R_{DS(on)}$ 3.5 Ω
- N channel
- Depletion mode
- High dynamic resistance

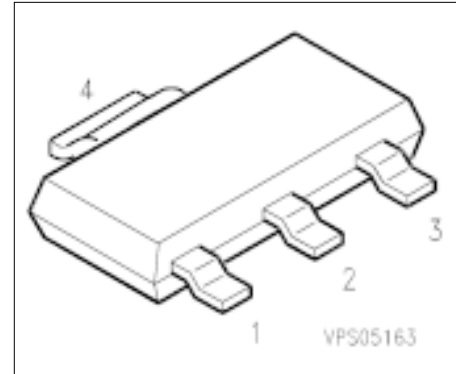

Type	Ordering Code	Tape and Reel Information	Pin Configuration				Marking	Package
			1	2	3	4		
BSP 149	Q67000-S071	E6327: 1000 pcs/reel	G	D	S	D	BSP 149	SOT-223

Maximum Ratings

Parameter	Symbol	Values	Unit	
Drain-source voltage	V_{DS}	200	V	
Drain-gate voltage, $R_{GS} = 20 \text{ k}\Omega$	V_{DGR}	200		
Gate-source voltage	V_{GS}	± 20		
ESD Sensitivity (HBM) as per MIL-STD 883	–	Class 1		
Continuous drain current, $T_A = 28 \text{ }^\circ\text{C}$	I_D	0.48	A	
Pulsed drain current, $T_A = 25 \text{ }^\circ\text{C}$	$I_{D \text{ puls}}$	1.44		
Max. power dissipation, $T_A = 25 \text{ }^\circ\text{C}$	P_{tot}	1.8	W	
Operating and storage temperature range	T_j, T_{stg}	$-55 \dots +150$	$^\circ\text{C}$	
Thermal resistance ¹⁾	chip-ambient	R_{thJA}	70	K/W
	chip-soldering point	R_{thJS}	10	
DIN humidity category, DIN 40 040	–	E	–	
IEC climatic category, DIN IEC 68-1	–	55/150/56	–	

¹⁾ Transistor on epoxy pcb 40 mm \times 40 mm \times 1.5 mm with 6 cm² copper area for drain connection.

Electrical Characteristics

 at $T_j = 25\text{ }^\circ\text{C}$, unless otherwise specified.

Parameter	Symbol	Values			Unit
		min.	typ.	max.	

Static Characteristics

Drain-source breakdown voltage $V_{GS} = -3\text{ V}$, $I_D = 0.25\text{ mA}$	$V_{(BR)DSS}$	200	–	–	V
Gate threshold voltage $V_{DS} = 3\text{ V}$, $I_D = 1\text{ mA}$	$V_{GS(th)}$	– 1.8	– 1.2	– 0.7	
Drain-source cutoff current $V_{DS} = 200\text{ V}$, $V_{GS} = -3\text{ V}$ $T_j = 25\text{ }^\circ\text{C}$ $T_j = 125\text{ }^\circ\text{C}$	I_{DSS}	– –	– –	0.2 200	μA
Gate-source leakage current $V_{GS} = 20\text{ V}$, $V_{DS} = 0$	I_{GSS}	–	10	100	nA
Drain-source on-resistance $V_{GS} = 0\text{ V}$, $I_D = 0.03\text{ A}$	$R_{DS(on)}$	–	2.5	3.5	Ω

Dynamic Characteristics

Forward transconductance $V_{DS} \geq 2 \times I_D \times R_{DS(on)max}$, $I_D = 0.48\text{ A}$	g_{fs}	0.4	0.75	–	S
Input capacitance $V_{GS} = 0$, $V_{DS} = 25\text{ V}$, $f = 1\text{ MHz}$	C_{iss}	–	500	670	μF
Output capacitance $V_{GS} = 0$, $V_{DS} = 25\text{ V}$, $f = 1\text{ MHz}$	C_{oss}	–	40	60	
Reverse transfer capacitance $V_{GS} = 0$, $V_{DS} = 25\text{ V}$, $f = 1\text{ MHz}$	C_{rss}	–	12	20	
Turn-on time t_{on} , ($t_{on} = t_{d(on)} + t_r$) $V_{DD} = 30\text{ V}$, $V_{GS} = -2 \dots + 5\text{ V}$, $R_{GS} = 50\text{ }\Omega$, $I_D = 0.29\text{ A}$	$t_{d(on)}$	–	7	10	ns
	t_r	–	20	30	
Turn-off time t_{off} , ($t_{off} = t_{d(off)} + t_f$) $V_{DD} = 30\text{ V}$, $V_{GS} = -2 \dots + 5\text{ V}$, $R_{GS} = 50\text{ }\Omega$, $I_D = 0.29\text{ A}$	$t_{d(off)}$	–	60	80	
	t_f	–	50	65	

Electrical Characteristics (cont'd)
 at $T_j = 25\text{ }^\circ\text{C}$, unless otherwise specified.

Parameter	Symbol	Values			Unit
		min.	typ.	max.	
Reverse Diode					
Continuous reverse drain current $T_A = 25\text{ }^\circ\text{C}$	I_S	–	–	0.48	A
Pulsed reverse drain current $T_A = 25\text{ }^\circ\text{C}$	I_{SM}	–	–	1.44	
Diode forward on-voltage $I_F = 0.96\text{ A}$, $V_{GS} = 0$	V_{SD}	–	0.9	1.2	V

Characteristics

at $T_j = 25\text{ }^\circ\text{C}$, unless otherwise specified.

Total power dissipation $P_{\text{tot}} = f(T_A)$

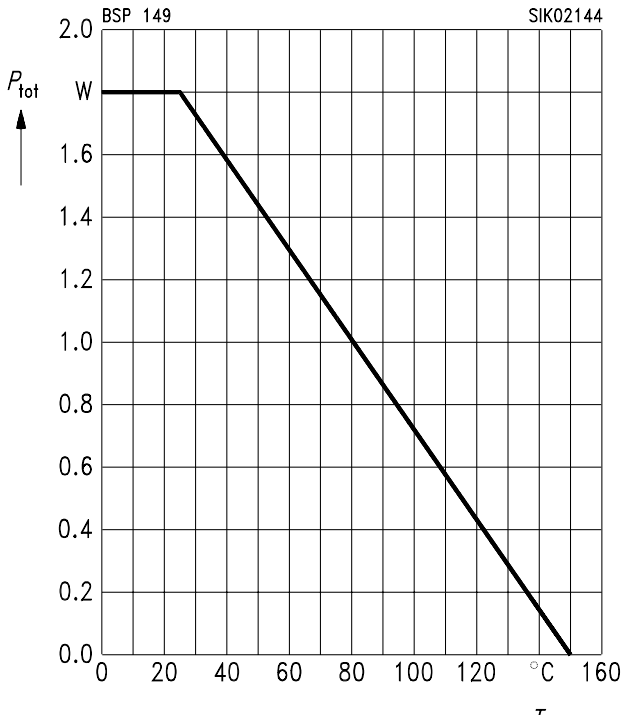

Safe operating area $I_D = f(V_{\text{DS}})$

parameter: $D = 0.01$, $T_C = 25\text{ }^\circ\text{C}$

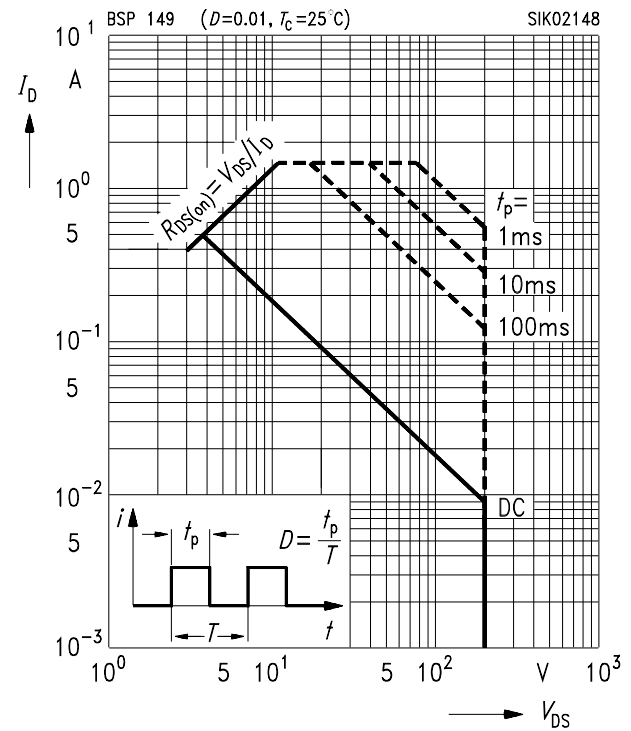

Typ. output characteristics $I_D = f(V_{\text{DS}})$

parameter: $t_p = 80\text{ }\mu\text{s}$

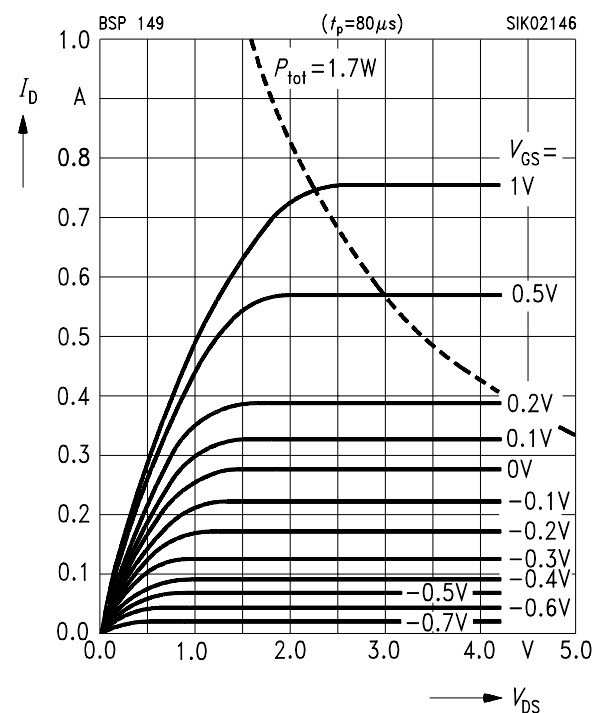

Typ. drain-source on-resistance

$R_{\text{DS(on)}} = f(I_D)$

parameter: V_{GS}

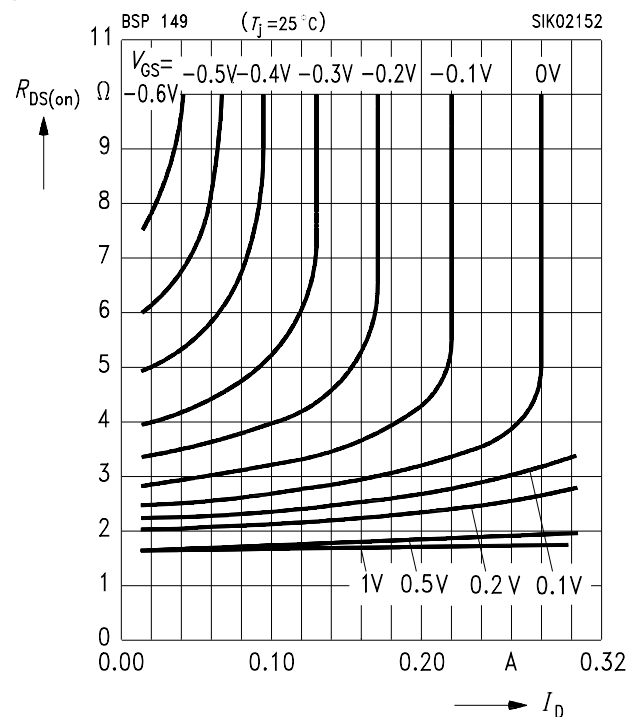

Typ. transfer characteristics $I_D = f(V_{GS})$
 parameter: $t_p = 80 \mu s$, $V_{DS} \geq 2 \times I_D \times R_{DS(on)max}$.

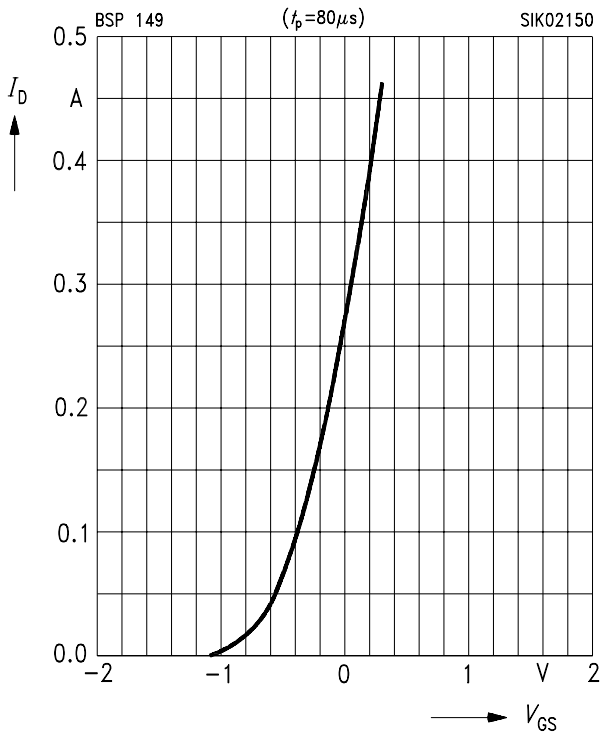

Typ. forward transconductance $g_{fs} = f(I_D)$
 parameter: $V_{DS} \geq 2 \times I_D \times R_{DS(on)max}$, $t_p = 80 \mu s$

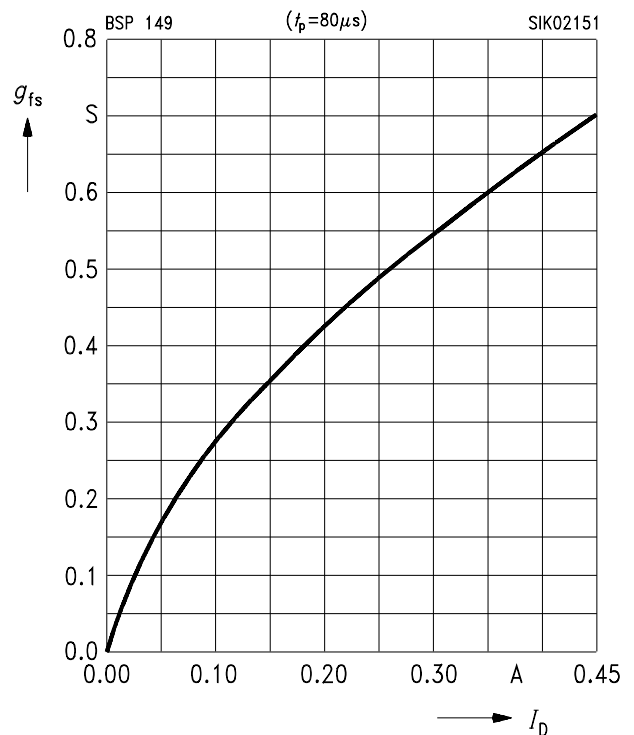

Drain-source on-resistance
 $R_{DS(on)} = f(T_j)$
 parameter: $I_D = 0.03 A$, $V_{GS} = 0 V$, (spread)

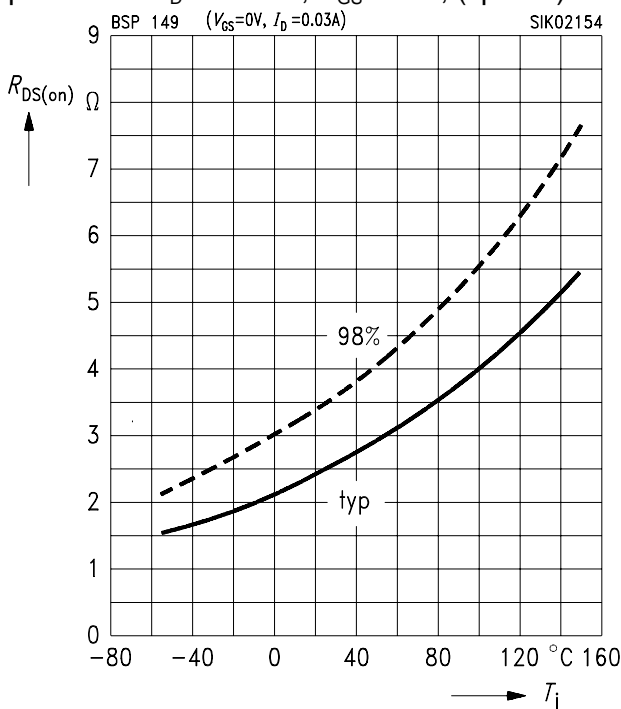

Typ. capacitances $C = f(V_{DS})$
 parameter: $V_{GS} = 0$, $f = 1 MHz$

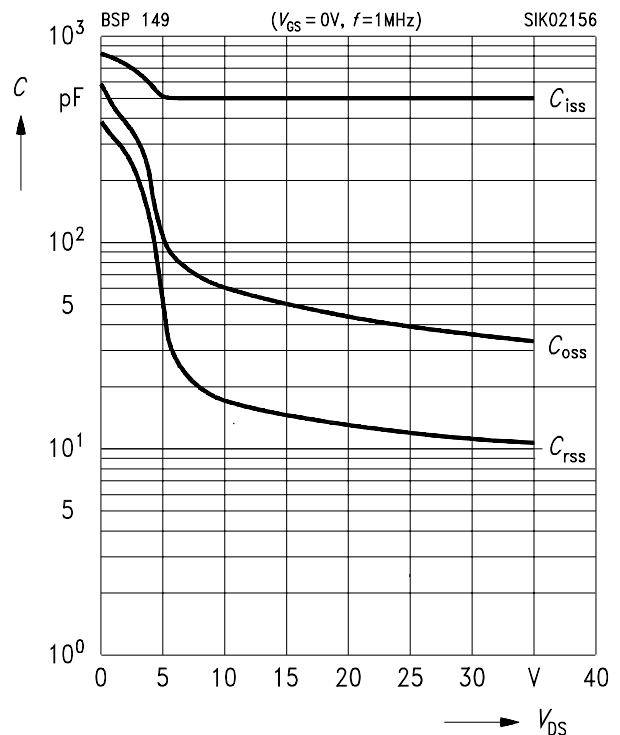

Gate threshold voltage $V_{GS(th)} = f(T_j)$
 parameter: $V_{DS} = 3\text{ V}$, $I_D = 1\text{ mA}$, (spread)

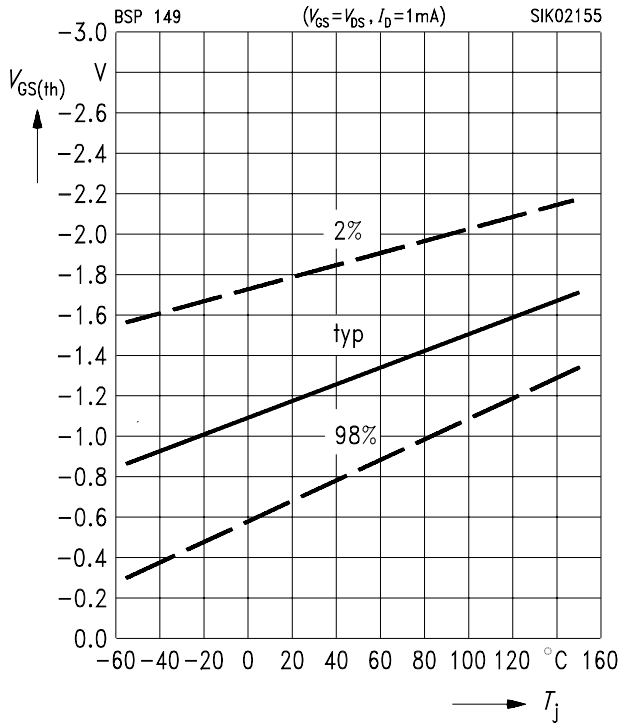

Forward characteristics of reverse diode

$I_F = f(V_{SD})$
 parameter: $t_p = 80\ \mu\text{s}$, T_j , (spread)

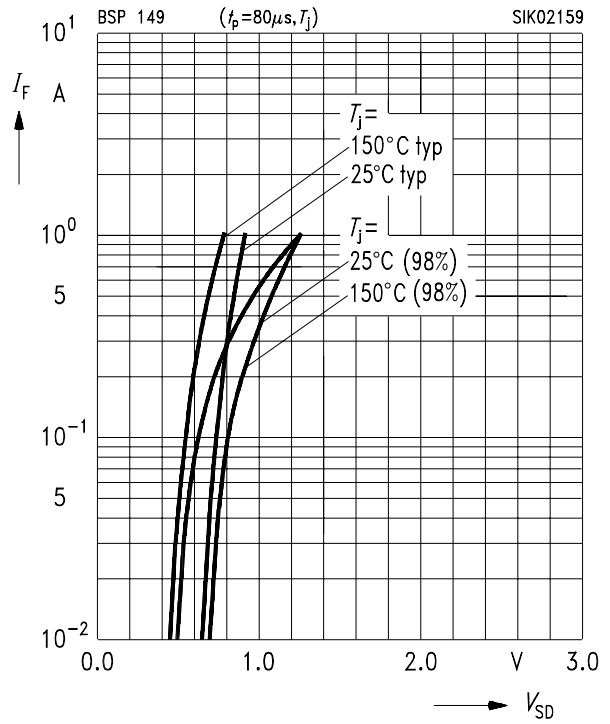

Drain current $I_D = f(T_A)$
 parameter: $V_{GS} \geq 3\text{ V}$

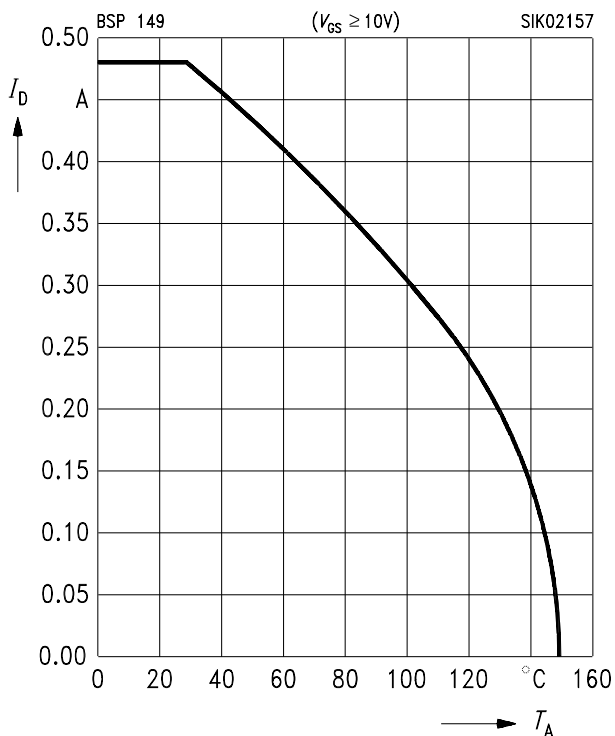

Safe operating area $I_D = f(V_{DS})$
 parameter: $D = 0$, $T_C = 25\text{ °C}$

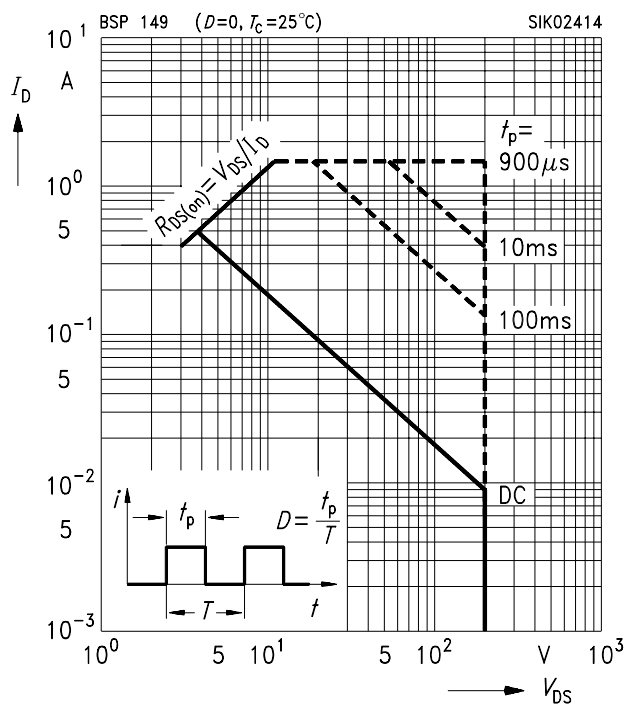

Drain-source breakdown voltage

$$V_{(BR)DSS} = b \times V_{(BR)DSS} (25\text{ }^{\circ}\text{C})$$

