



NOTE

All numerical values are in metric units [with U.S. customary units in brackets]. Dimensions are in millimeters. Unless otherwise specified, dimensions have a tolerance of $\pm 0.1\text{mm}$ and angles have a tolerance of $\pm 2^\circ$. Figures and illustrations are for identification only and are not drawn to scale.

1. INTRODUCTION

This specification covers the requirements for application of CoolSplice connectors used for an electrical power connection. This connector is available in unsealed and sealed for multiple wire gauges. The connector consists of a housing with a wire entry hole at each end, an internal contact, and two buttons. The wire entry holes, which are designated as A and B. The housing features a stop that ensures proper wire insertion depth. When pressed, the buttons force the wires into the contact for left or right side independent termination. The housing design provides strain relief for the wire.



NOTE

It is strongly recommended to locate the sealed connector inside an enclosure if it is used outside or underground.

When corresponding with personnel, use the terminology provided in this specification to facilitate inquiries for information. Basic terms and features of this product are provided in Figure 1.

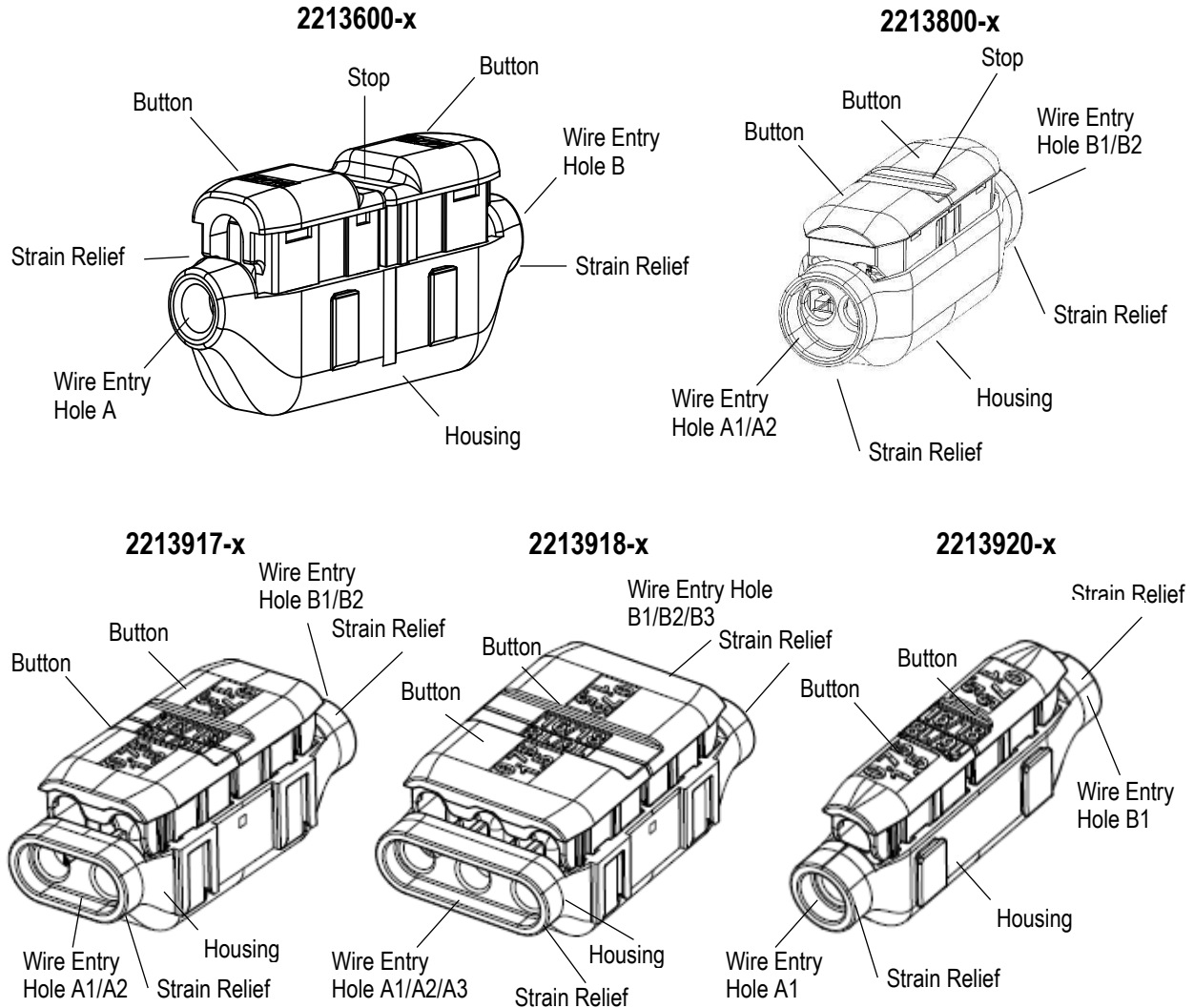

Figure 1

Part number	WIRE SIZE (AWG) FOR CONNECTOR				CONNECTOR	
	WIRE ENTRY HOLE A	BUTTON COLOR	WIRE ENTRY HOLE B	BUTTON COLOR	TYPE	HOUSING COLOR
2213600-1	12-14 (4 mm ² – 2.5 mm ²)	Yellow	14-16 (2.5 mm ² – 1.5 mm ²)	Blue	IPx5, IPx7 & IPx8	Clear
2213600-2	12-14 (4 mm ² – 2.5 mm ²)	Yellow	16-18 (1.5 mm ² – 0.75 mm ²)	Red		
2213600-3	14-16 (2.5 mm ² – 1.5 mm ²)	Blue	16-18 (1.5 mm ² – 0.75 mm ²)	Red		
2213600-4	12-14 (4 mm ² – 2.5 mm ²)	Yellow	14-16 (2.5 mm ² – 1.5 mm ²)	Blue	IP20	
2213600-5	12-14 (4 mm ² – 2.5 mm ²)	Yellow	16-18 (1.5 mm ² – 0.75 mm ²)	Red		
2213600-6	14-16 (2.5 mm ² – 1.5 mm ²)	Blue	16-18 (1.5 mm ² – 0.75 mm ²)	Red		
2213800-1	18 (0.75 mm ²)	Green	18 (0.75 mm ²)	Green	IP20	
2213800-2	18 (0.75 mm ²)	Blue	18 (0.75 mm ²)	Blue	IPx5, IPx7 & IPx8	
2213800-3	20-22 (0.5 mm ² – 0.34 mm ²)	Green	20-22 (0.5 mm ² – 0.34 mm ²)	Green	IP20	
2213800-4	20-22 (0.5 mm ² – 0.34 mm ²)	Blue	20-22 (0.5 mm ² – 0.34 mm ²)	Blue	IPx5, IPx7 & IPx8	
2213917-1	16-18 (1.5 mm ² – 0.75 mm ²)	Red	16-18 (1.5 mm ² – 0.75 mm ²)	Red	IP20	
2213917-2	16-18 (1.5 mm ² – 0.75 mm ²)	Red	16-18 (1.5 mm ² – 0.75 mm ²)	Red	IPx5, IPx7 & IPx8	
2213917-3	16-18 (1.5 mm ² – 0.75 mm ²)	Red	20-22 (0.5 mm ² – 0.34 mm ²)	Green	IP20	
2213917-4	16-18 (1.5 mm ² – 0.75 mm ²)	Red	20-22 (0.5 mm ² – 0.34 mm ²)	Green	IPx5, IPx7 & IPx8	
2213917-5	20-22 (0.5 mm ² – 0.34 mm ²)	Green	20-22 (0.5 mm ² – 0.34 mm ²)	Green	IP20	
2213917-6	20-22 (0.5 mm ² – 0.34 mm ²)	Green	20-22 (0.5 mm ² – 0.34 mm ²)	Green	IPx5, IPx7 & IPx8	

Part number	WIRE SIZE (AWG) FOR CONNECTOR				CONNECTOR	
	WIRE ENTRY HOLE A	BUTTON COLOR	WIRE ENTRY HOLE B	BUTTON COLOR	TYPE	HOUSING COLOR
2213918-1	16-18 (1.5 mm ² – 0.75 mm ²)	Red	16-18 (1.5 mm ² – 0.75 mm ²)	Red	IP20	Clear
2213918-2	16-18 (1.5 mm ² – 0.75 mm ²)	Red	16-18 (1.5 mm ² – 0.75 mm ²)	Red	IPx5, IPx7 & IPx8	
2213918-3	16-18 (1.5 mm ² – 0.75 mm ²)	Red	20-22 (0.5 mm ² – 0.34 mm ²)	Green	IP20	
2213918-4	16-18 (1.5 mm ² – 0.75 mm ²)	Red	20-22 (0.5 mm ² – 0.34 mm ²)	Green	IPx5, IPx7 & IPx8	
2213918-5	20-22 (0.5 mm ² – 0.34 mm ²)	Green	20-22 (0.5 mm ² – 0.34 mm ²)	Green	IP20	
2213918-6	20-22 (0.5 mm ² – 0.34 mm ²)	Green	20-22 (0.5 mm ² – 0.34 mm ²)	Green	IPx5, IPx7 & IPx8	
2213920-1	16-18 (1.5 mm ² – 0.75 mm ²)	Red	16-18 (1.5 mm ² – 0.75 mm ²)	Red	IP20	
2213920-2	16-18 (1.5 mm ² – 0.75 mm ²)	Red	16-18 (1.5 mm ² – 0.75 mm ²)	Red	IPx5, IPx7 & IPx8	
2213920-3	16-18 (1.5 mm ² – 0.75 mm ²)	Red	20-22 (0.5 mm ² – 0.34 mm ²)	Green	IP20	
2213920-4	16-18 (1.5 mm ² – 0.75 mm ²)	Red	20-22 (0.5 mm ² – 0.34 mm ²)	Green	IPx5, IPx7 & IPx8	
2213920-5	20-22 (0.5 mm ² – 0.34 mm ²)	Green	20-22 (0.5 mm ² – 0.34 mm ²)	Green	IP20	
2213920-6	20-22 (0.5 mm ² – 0.34 mm ²)	Green	20-22 (0.5 mm ² – 0.34 mm ²)	Green	IPx5, IPx7 & IPx8	

Figure 2

2. REFERENCE MATERIAL

2.1. Revision Summary

Initial release of application specification

2.2. Customer Assistance

Reference Product Base Part Number 2213600 and 2213800 and Product Code L938 are representative of CoolSplice connector. Use of these numbers will identify the product line and help you to obtain product and tooling information when visiting www.te.com or calling the number at the bottom of page 1.

2.3. Drawings

Customer drawings for product part numbers are available from www.te.com. Information contained in the customer drawing takes priority.

2.4. Specifications

- 108-133061 Product Specification, provides product performance and test results.
- 107-133061 Product packaging specification
- 501-19232 Qualification Test Report: 2213600-x CoolSplice Large Gauge
- 501-19234 Qualification Test Report: 2213800-x CoolSplice New Standard

3. REQUIREMENTS

3.1. Storage

A. Ultraviolet Light

Prolonged exposure to ultraviolet light may deteriorate the chemical composition used in the product material.

B. Shelf Life

The product should remain in the shipping containers until ready for use to prevent deformation to components. The product should be used on a first in, first out basis to avoid storage contamination that could adversely affect performance.

C. Chemical Exposure

Do not store product near any chemical listed below as they may cause stress corrosion cracking in the material.

Alkalies	Ammonia	Citrates	Phosphates	Citrates	Sulfur Compounds
Amines	Carbonates	Nitrites	Sulfur Nitrites		Tartrates

3.2. Wire Selection and Preparation

The connector accepts copper solid and/or stranded wire having the sizes and types given in Figure 3. Non-concentric wire is not acceptable.



NOTE

For suitability of other wire types, call the number at the bottom of page 1.

The wire must be clean and free of contaminates, such as dust or other substances that can compromise the insulation diameter. The wire insulation must not be damaged or cut. The wire must have no spacing deformation or burrs. The wire must not be stripped.

The jacket end must have a clean straight cut or cut with maximum angle of 10°.

Connector	Wire size AWG (mm ²)	Maximum jacket diameter	Max. current ¹	Max. strands	Must meet standard
2213600-x	18 (0.75 mm ²)	3.5 mm	10 A	19	UL 1015 or equivalent
	16 (1.5 mm ²)	4.0 mm	15 A	19	
	14 & 12 (2.5 mm ² & 4 mm ²)	4.5 mm	15 A	19	
2213800-x	22 (0.34 mm ²)	2.85 mm	5 A	7	UL1007, UL 1015 or equivalent
	20 (0.5 mm ²)	2.85 mm	6.5 A	18	
	18 (0.75 mm ²)	2.85 mm	6.5 A	19	
2213917	22 (0.34 mm ²)	2.85 mm	6 A	7	
	20 (0.5 mm ²)	2.85 mm	8 A	18	
	18 (0.75 mm ²)	3.5 mm	8 A	19	
2213918	16 (1.5 mm ²)	3.5 mm	12 A	19	
	22 (0.34 mm ²)	2.85 mm	5 A	7	
	20 (0.5 mm ²)	2.85 mm	6.5 A	18	
2213920	18 (0.75 mm ²)	3.5 mm	6.5 A	19	
	16 (1.5 mm ²)	3.5 mm	10 A	19	
	22 (0.34 mm ²)	2.85 mm	7 A	7	
	20 (0.5 mm ²)	2.85 mm	10 A	18	
	18 (0.75 mm ²)	3.5 mm	10 A	19	
	16 (1.5 mm ²)	3.5 mm	14 A	19	



Jacket End Cut Straight or with 10° Maximum Angle

¹ For maximum current rating by UL and KEMA see 108-133061

Figure 3

3.3. Wire Insertion

A wire must be inserted into one or both wire entry holes of the connector until it bottoms on the stop or at least 1 mm past the end of the associated button. The wires can be visually inspected for proper depth through the transparent housing. See Figure 4.



NOTE

This connector is not designed to be used as a wire end cap.

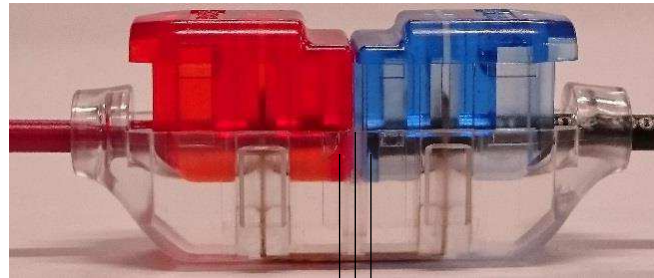

Wire Bottomed on Stop or
1 mm Min Past End of Associated Button

Wire Bottomed on Stop or
1 mm Min Past End of Associated Button

Figure 4

3.4. Termination

Wires must be held in place during termination to prevent them from moving out of position. The anvil of the tool must be placed on the top center of the button to prevent uneven seating. Each button must be closed (one at a time) using a maximum force of 500 N [112 lb-force], hold for 1 - 2 seconds.

A. Wire Placement

Each wire must be bottomed on the stop or at least 1 mm past the end of the associated button. There must be no exposed copper wire chips or broken wire strands. Refer to **Error! Reference source not found.**

B. Housing and Contact

There must be no apparent damage or cracks in the housing and no sign of a bent or misaligned contact.

C. Buttons

The top of each button must be flush with the top of the housing. There must be no apparent damage or cracks in the buttons. See **Error! Reference source not found.**

D. Connector Height

The connector must be within the connector height dimension given in **Error! Reference source not found.**

Note: Not to Scale

2213600-x

11.5±0.2
Connector Height
Top of Button to
Bottom of Housing

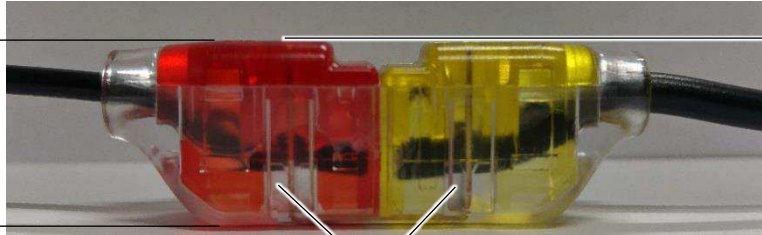

Top of Buttons Flush
with Top of Housing

No Damage or Cracks in
Buttons or Housing

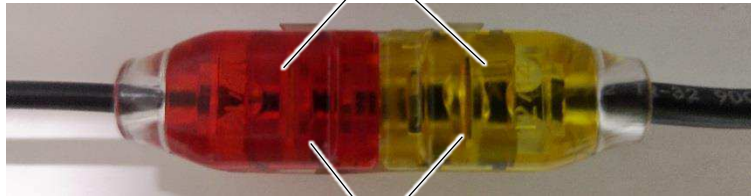

No Sign of Bent or
Misaligned Contact

2213800-x

11.4±0.2 Connector
Height Top of Button to
Bottom of Housing

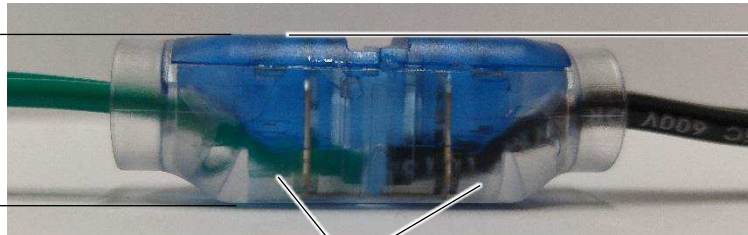

Top of Buttons Flush
with Top of Housing

No Damage or Cracks in
Buttons or Housing

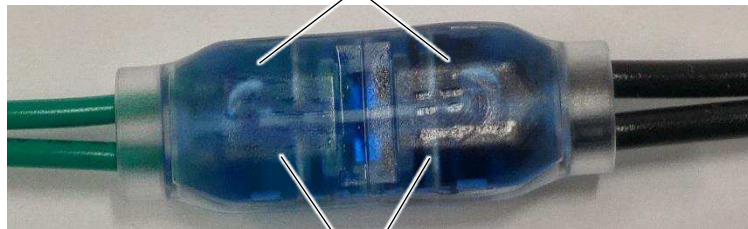

No Sign of Bent or
Misaligned Contact

Note: Not to Scale

Figure 5

3.5. Replacement and Repair

A damaged or defective connector must not be used. The connector cannot be repaired. The connector must not be re-used by removing or lifting the buttons before or after termination.

4. QUALIFICATION

The 2213600-x CoolSplice Large Wire is Listed by Underwriters Laboratories Inc. (UL 486C), file E13288.

The 2213600-x CoolSplice Large Wire is certified against IEC 60998-2-3, certificate number NL-43716.

The 2213800-x CoolSplice New Standard is Listed by Underwriters Laboratories Inc. (UL 2459), file E308110.

The 2213800-x CoolSplice New Standard is Recognized by Underwriters Laboratories Inc. (UL 1977), file E28476.

The 2213800-1 & -2 CoolSplice New Standard is certified against IEC 60998-2-3, certificate number NL-43429.

The 2213800-3 & -4 CoolSplice New Standard is certified against IEC 60998-2-3, certificate number NL-43430.

The 2213917-x CoolSplice Large Wire is Listed by Underwriters Laboratories Inc. (UL 486C), file EXXXX.

The 2213917-x CoolSplice Large Wire is certified against IEC 60998-2-3, certificate number NL-XXXX.

The 2213918-x CoolSplice Large Wire is Listed by Underwriters Laboratories Inc. (UL 486C), file EXXXX.

The 2213918-x CoolSplice Large Wire is certified against IEC 60998-2-3, certificate number NL-XXXX.

The 2213920-x CoolSplice Large Wire is Listed by Underwriters Laboratories Inc. (UL 486C), file EXXXX.

The 2213920-x CoolSplice Large Wire is certified against IEC 60998-2-3, certificate number NL-43716.

5. TOOLING

A standard pliers as shown in Figure 6 can be used for termination of the connector.

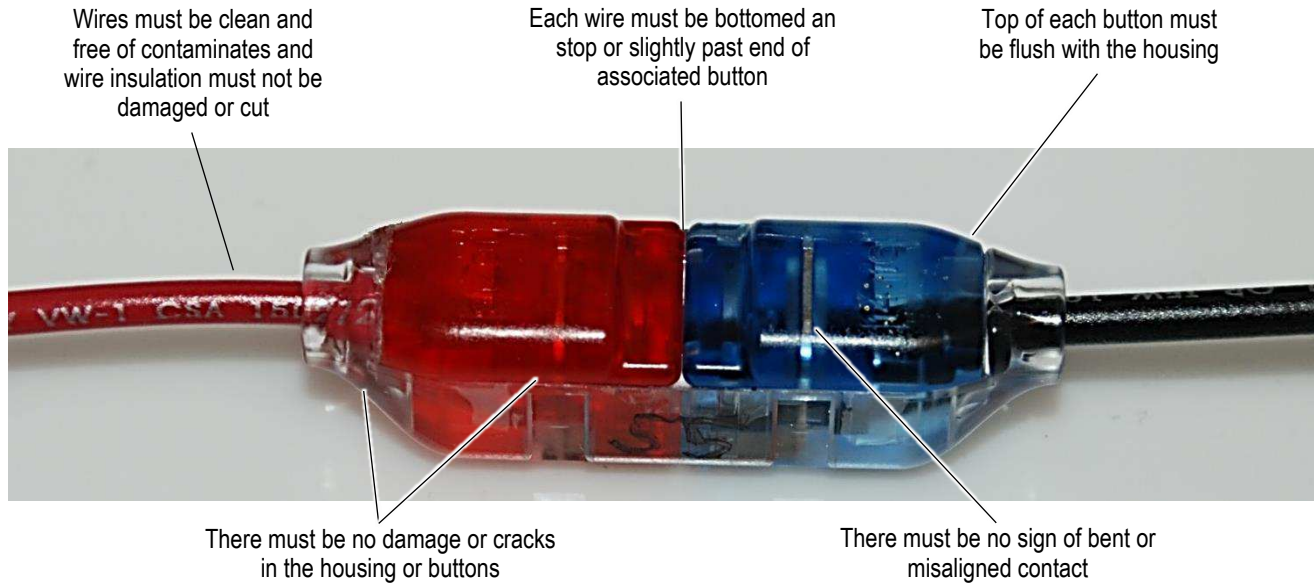

Figure 6

6. VISUAL AID

The illustration below shows a typical application of single position large wire-to-wire IDC CoolSplice connector. This illustration should be used by production personnel to ensure a correctly applied product. Applications which do not appear correct should be inspected using the information in the preceding pages of this specification and in the instructional material shipped with the product or tooling.

2213600-x



2213800-x

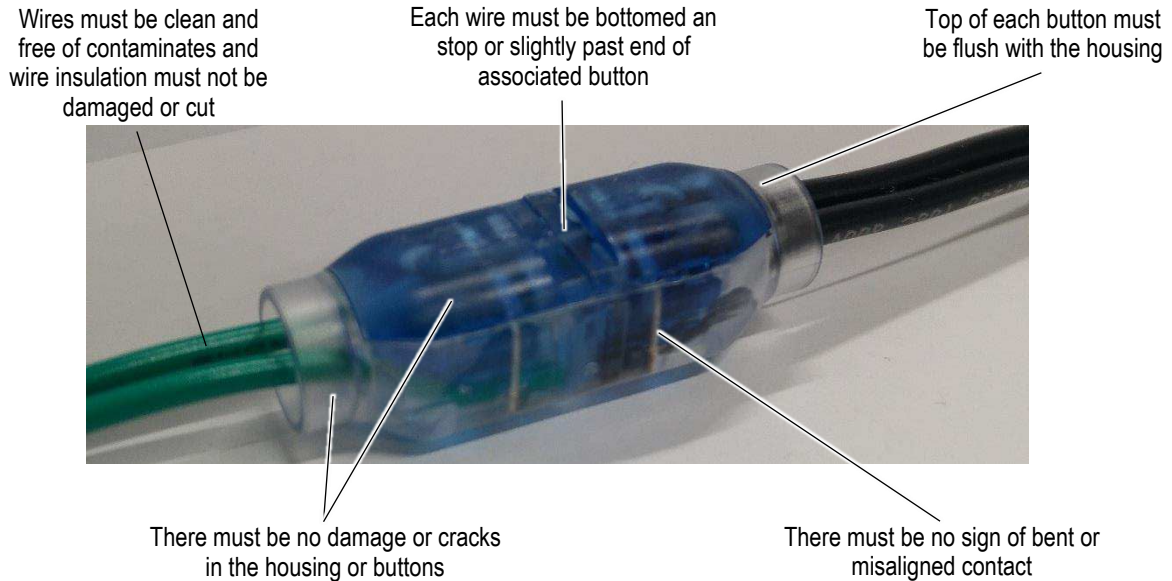

Figure 7.