

# SPDM



## Single Phase Power Supply



### Benefits

- **Power in compact dimensions.** The SPDM provide up to +30% space saving when compared to SPD
- **Reliable and cost saving.** The SPDM provide high reliability power at an attractive price level
- **Low power loss, high efficiency.** The compact design results in low energy losses and high efficiency
- **Intuitive indication.** A clear LED indicate the status of the power supply
- **Universal AC, DC input range.** SPDM Series can be powered with AC Voltage (85VAC to 264VAC) or with DC Voltage (130VDC to 350VDC).
- **Reliable critical protection.** The operation safety is guaranteed by the various output protections: Over Voltage (OVP), Over Load (OLP), Short Circuit (SCP) and Over Temperature (OTP).
- **High efficiency and wide operating ambient temperature.** These power supplies have an efficiency up to 88%.
- **Ease of installation.** The SPDM can be installed in 5 different orientations, enabling the unit to fit easily into installations with limited space.

### Description

The SPDM is designed to be used in all automation applications, where it can be easily installed on the Din Rail and save installation time by up to 50% with the option of the spring terminal. The SPDM is a premium quality product at a attractive price level. Reliability is guaranteed through the multiple integrated protections.

### Applications

This product is extremely suitable for all applications which require single-phase power supply with universal voltage input and high efficiency.

### Main functions

- Compact dimension of up to 45mm width
- High efficiency up to 88%
- Universal input voltage range: 85VAC to 264VAC; 130VDC to 350VDC
- 30W, 50W, 75W, 120W, 240W
- Screw or Spring terminals

## References

### Order code

 SPDM   1

Enter the code entering the corresponding option instead of

Code	Option	Description	Notes
S	-	Switching	Device typology
P	-	Power	
D	-	DIN rail	
M	-	Medium	
<input type="checkbox"/>	12	12VDC	Rated output voltage
	24	24VDC	
	48	48VDC	
<input type="checkbox"/>	30	30W	Rated output power
	50	50W	
	75	75W	
	120	120W	
	240	240W	
1	-	Single phase input	Input type
	B	Spring terminal	Terminal type

### Selection guide

Output Voltage	30W	50W	75W	120W	240W
12VDC	SPDM12301/B	SPDM12501/B	SPDM12751/B	SPDM121201	-
24VDC	SPDM24301/B	SPDM24501/B	SPDM24751/B	SPDM241201	SPDM242401
48VDC	-	-	-	SPDM481201	SPDM482401

### Further reading

Information	Where to find it	QR
SPDM DatasheetSheet	<a href="http://www.productselection.net/Pdf/UK/PS_SPDM_DS.pdf">http://www.productselection.net/Pdf/UK/PS_SPDM_DS.pdf</a>	
SPDM Installation Sheet	<a href="http://www.productselection.net/MANUALS/UK/PS_SPDM_IM.pdf">http://www.productselection.net/MANUALS/UK/PS_SPDM_IM.pdf</a>	
SPDM CAD drawings	<a href="http://www.productselection.net/DXF/PS_SPDM.zip">http://www.productselection.net/DXF/PS_SPDM.zip</a>	

# SPDM

## Structure

SPDM 30W



SPDM 50W

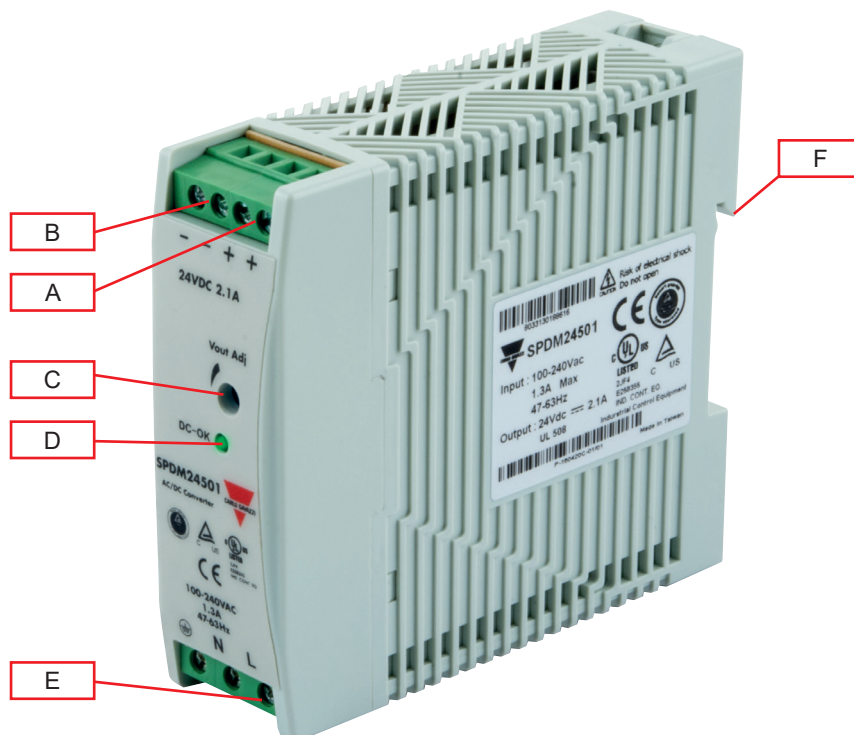

# SPDM



## SPDM 75W

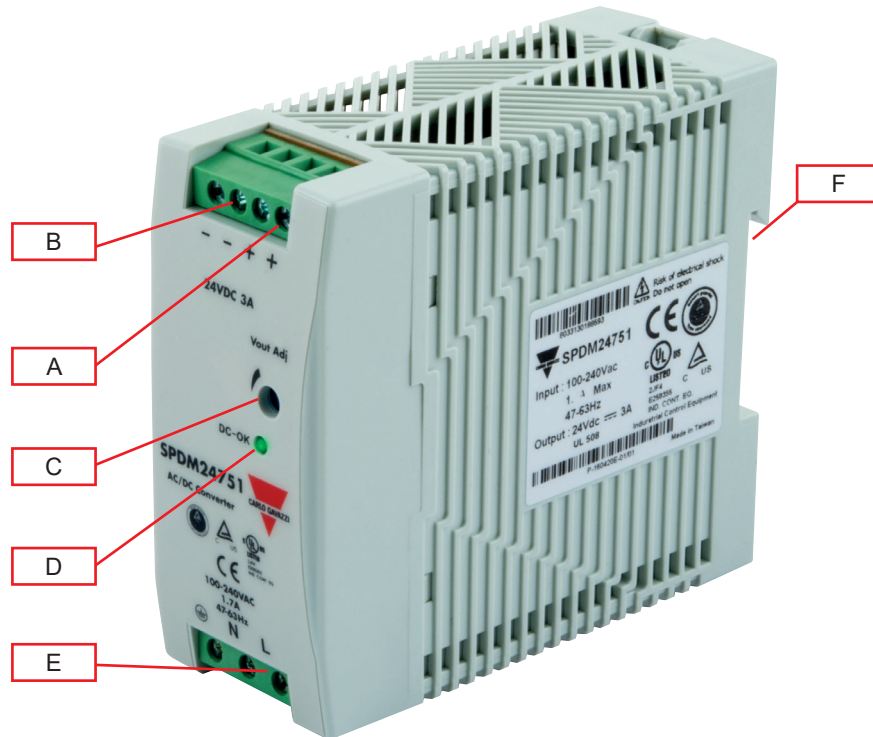

SPDM 30W / SPDM 50W / SPDM 75W		
Element	Component	Function
A	+ V terminals	Positive DC Output terminals
B	- V terminals	Negative DC Output terminals
C	VADJ Trimmer	Output voltage adjustment
D	DC OK LED	Green when output voltage $\geq 90\%$ of rated output voltage Red when output voltage $\leq 80\%$ of rated output voltage, or, Overload
E	Power supply terminals	L, N supply terminals + GND
F	DIN rail mounting clip	Clip present on back side

# SPDM



## SPDM 120W

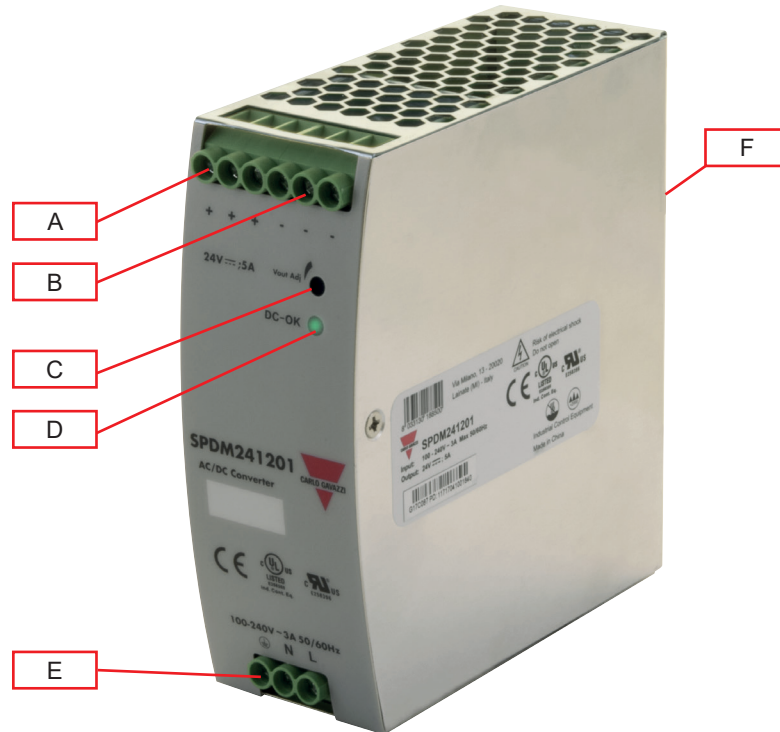

## SPDM 240W

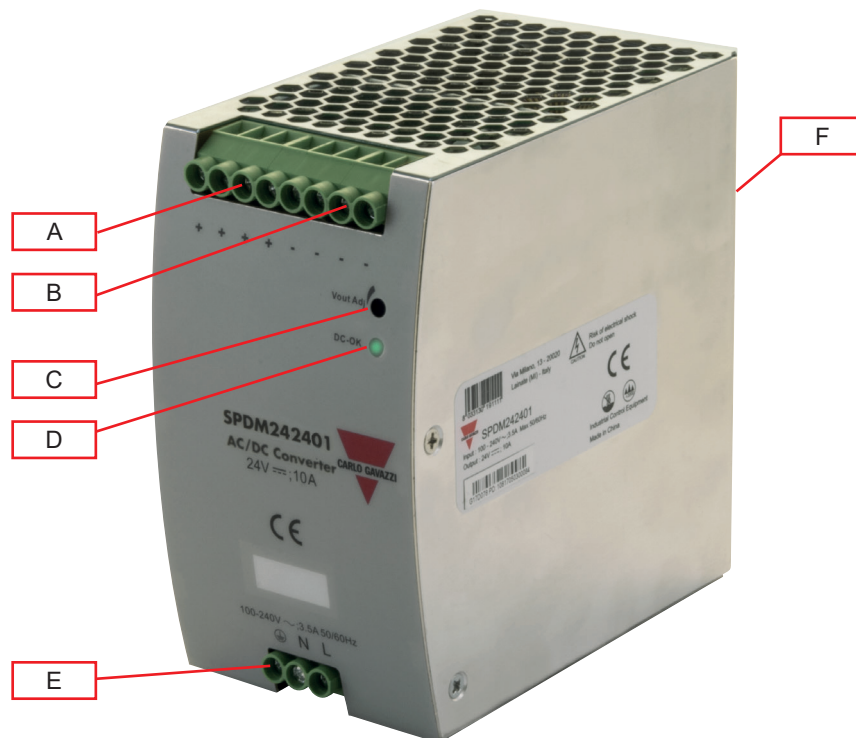

SPDM 120W / SPDM 240W		
Element	Component	Function
A	+ V terminals	Positive DC Output terminals
B	- V terminals	Negative DC Output terminals
C	VADJ Trimmer	Output voltage adjustment
D	DC OK LED	Green when output voltage $\geq 90\%$ of rated output voltage Red when output voltage $\leq 80\%$ of rated output voltage, or, Overload
E	Power supply terminals	L, N supply terminals + GND
F	DIN rail mounting clip	Clip present on back side

## Features

### General data

	SPDM 30W	SPDM 50W	SPDM 75W	SPDM 120W	SPDM 240W
Leakage current	<0.25mA (Input-Output)				
Earth leakage current	<3.5mA (Input-GND)				
Efficiency	86%	87%	87%	85% (12VDC) 88% (24VDC) 89% (48VDC)	87% (24VDC) 88% (48VDC)
Power loss @ nominal load	4.9W (12VDC) 5.7W (24VDC)	8.0W (12VDC) 8.8W (24VDC)	10.5W (12VDC) 10.5W (24VDC)	16W @ 120W	35W @ 240W
Power Factor (Full Load) 110VAC 230VAC	-	-	-	-	0.98 0.94
Ingress Protection	IP20				
MTBF	721,000Hrs (12V) 764,000Hrs (24V) Bellcore Issue 6 @40°C, GB	556,000Hrs (12V) 580,000Hrs (24V) Bellcore Issue 6 @40°C, GB	556,000Hrs (12V) 580,000Hrs (24V) Bellcore Issue 6 @40°C, GB	>500,000Hrs (MIL-HDBK-217F)	>300,000Hrs (MIL-HDBK-217F)
Case material	Plastic			Metal	
Weight	140g	200g	250g	590g	940g
Switching Frequency	65kHz		40 to 100kHz	80KHz	75z
Mounting	DIN rail mounting				
Packing	0.15Kg; 60 pcs / 10Kg / 2.16cuft	0.22Kg; 48 pcs / 12Kg / 2.16cuft	0.27Kg; 40 pcs / 12Kg / 2.16cuft	24pcs/CTN, 15.0Kg, 0.04cbm	10pcs/CTN, 11.5Kg, 0.04cbm

(All specifications are at nominal values, full load, 25°C unless otherwise stated)

# SPDM



## Dimensions

**SPDM 30W**  
Unit: mm

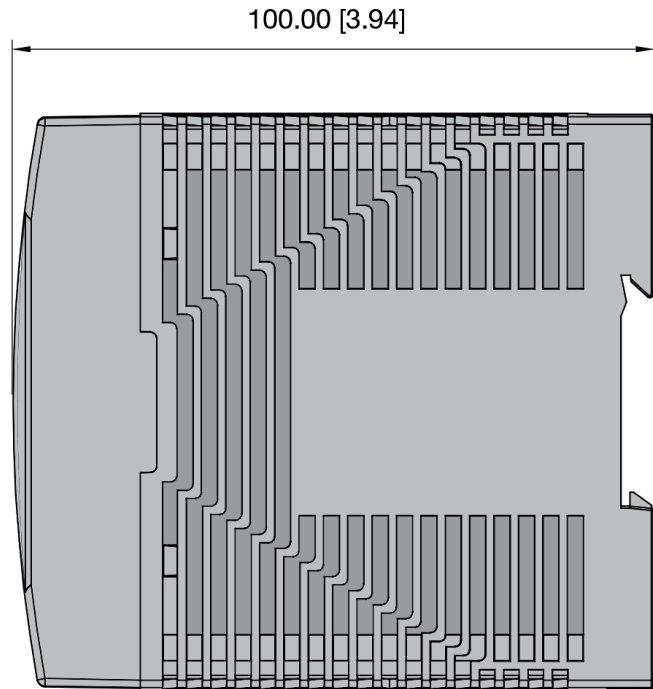
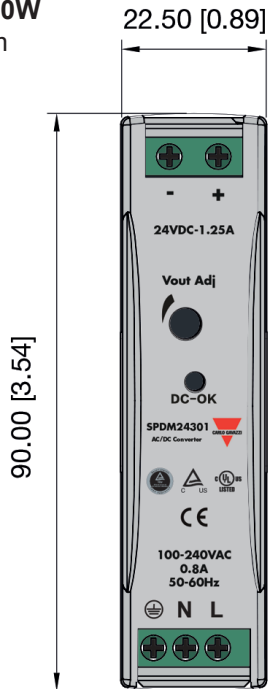

**SPDM 50W**  
Unit: mm

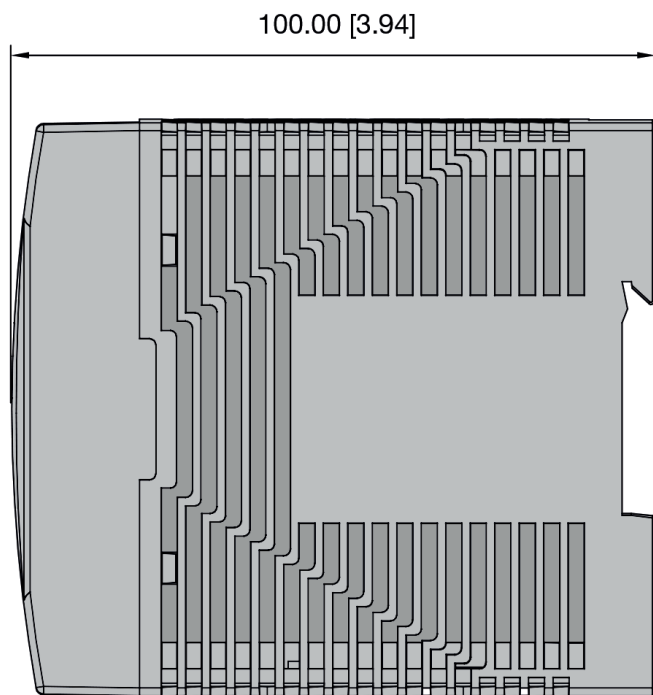
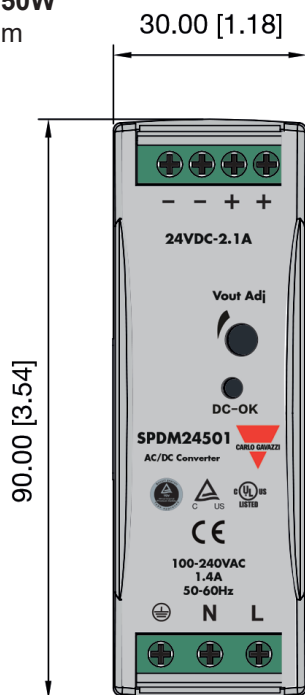

# SPDM



**SPDM 75W**  
Unit: mm

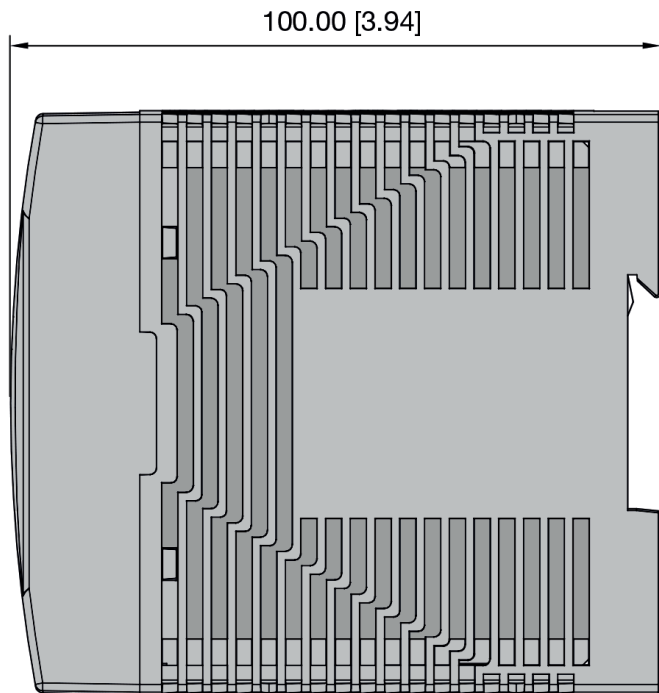
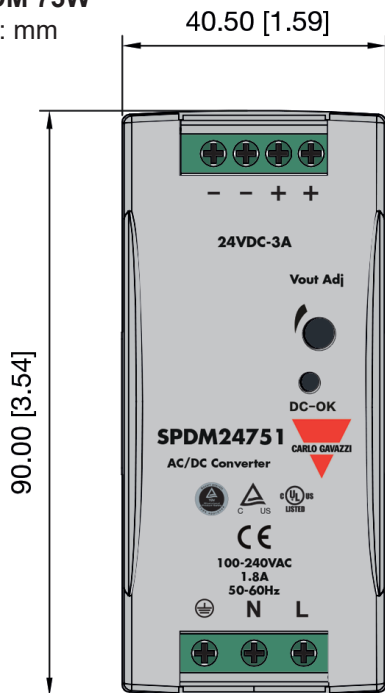

**SPDM 120W**  
Unit: mm

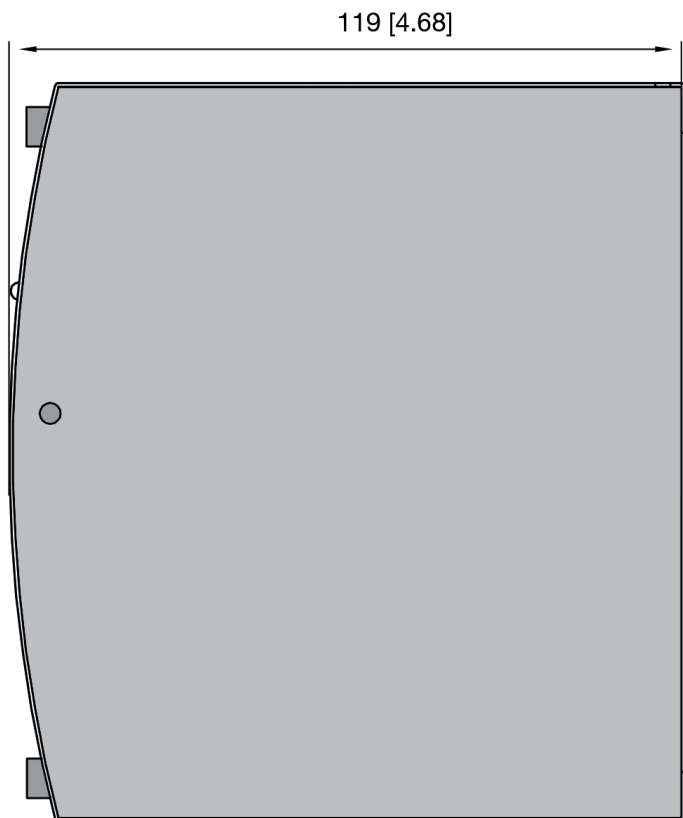
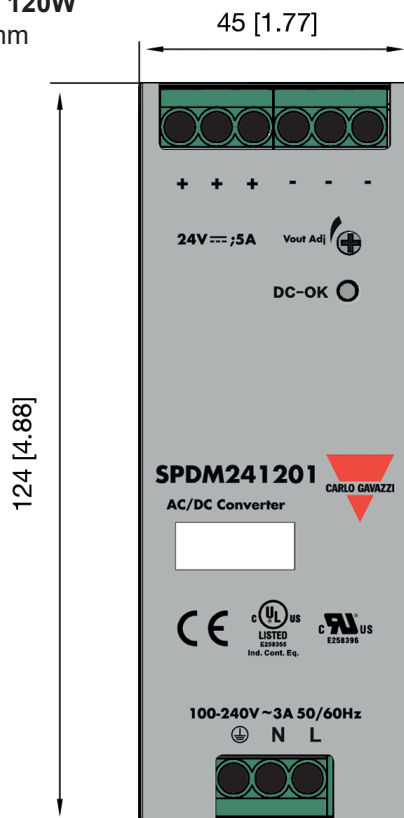



# SPDM



## SPDM 240W

Unit: mm

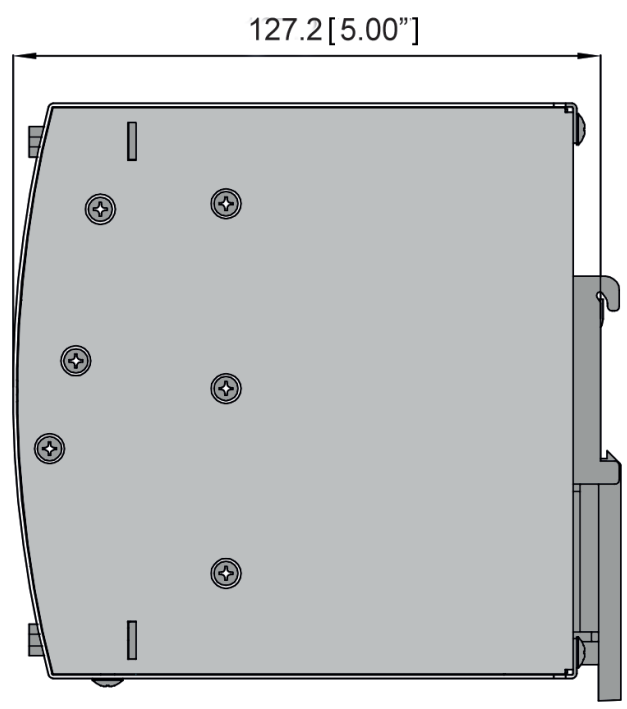
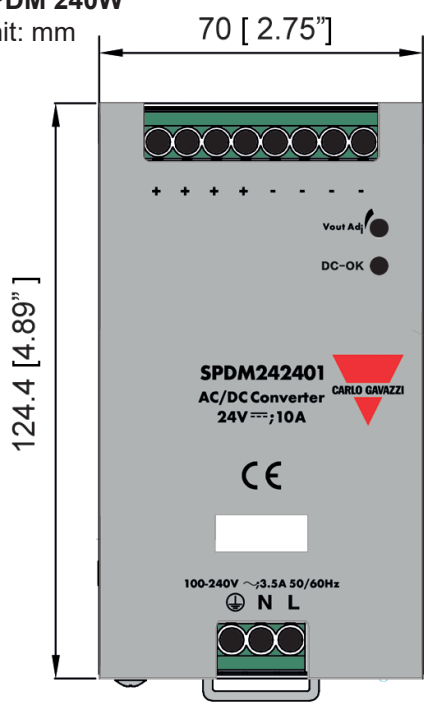

# SPDM



## Connection diagram

### Terminal markings

#### SPDM 30W

Terminal	Designation	Description
1	Ground	Ground this terminal to minimize high frequency emissions
2	N	Input terminals (neutral conductor, no polarity with DC input)
3	L	Input terminals (phase conductor, no polarity with DC input)
4	V+	Positive output terminal
5	V-	Negative output terminal
	Vout ADJ.	Potentiometer for output voltage adjustment
	DC status	LED indication of power supply output status



#### SPDM 50W

Terminal	Designation	Description
1	Ground	Ground this terminal to minimize high frequency emissions
2	N	Input terminals (neutral conductor, no polarity with DC input)
3	L	Input terminals (phase conductor, no polarity with DC input)
4, 5	V+	Positive output terminal
6, 7	V-	Negative output terminal
	Vout ADJ.	Potentiometer for output voltage adjustment
	DC status	LED indication of power supply output status



#### SPDM 75W

Terminal	Designation	Description
1	Ground	Ground this terminal to minimize high frequency emissions
2	N	Input terminals (neutral conductor, no polarity with DC input)
3	L	Input terminals (phase conductor, no polarity with DC input)
4, 5	V+	Positive output terminal
6, 7	V-	Negative output terminal
	Vout ADJ.	Potentiometer for output voltage adjustment
	DC status	LED indication of power supply output status



# SPDM



## SPDM 120W

Terminal	Designation	Description
1	Ground	Ground this terminal to minimize high frequency emissions
2	N	Input terminals (neutral conductor, no polarity with DC input)
3	L	Input terminals (phase conductor, no polarity with DC input)
4, 5, 6	V+	Positive output terminal
7, 8, 9	V-	Negative output terminal
	Vout ADJ.	Potentiometer for output voltage adjustment
	DC status	LED indication of power supply output status

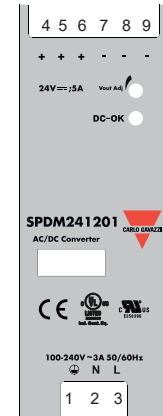

## SPDM 240W

Terminal	Designation	Description
1	Ground	Ground this terminal to minimize high frequency emissions
2	N	Input terminals (neutral conductor, no polarity with DC input)
3	L	Input terminals (phase conductor, no polarity with DC input)
4, 5, 6, 7	V+	Positive output terminal
8, 9, 10, 11	V-	Negative output terminal
	Vout ADJ.	Potentiometer for output voltage adjustment
	DC status	LED indication of power supply output status

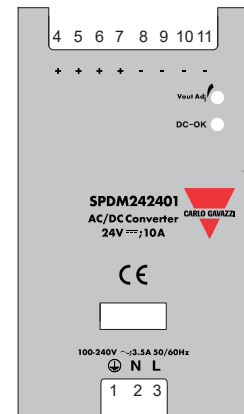

## Environmental

	SPDM 30W	SPDM 50W	SPDM 75W	SPDM 120W	SPDM 240W
Temperature operating range	-25°C to 71°C -13°F to 159.8°F			-20°C to 70°C -4°F to 158°F	
Temperature storage	-40°C to 85°C -40°F to 185°F				
Humidity	20% to 95% RH No condensing			20% to 90% RH No condensing	
Temperature derating	Refer to derating diagrams				
Temperature regulation	+/- 0.03%/°C				

## Compatibility and conformity

	SPDM 30W	SPDM 50W	SPDM 75W	SPDM 120W	SPDM 240W
Safety Standards	EN60950-1				
EMC Emission	EN61000-6-3:2007+A1:2011+AC:2012 EN61204-3:2000			EN55022, EN55024, FCC PART 15 Class B	EN55022, EN55024, Class B
Harmonic current	EN 61000-3-2			EN61000-3-2, Class A	
EMC immunity	EN 61000-6-2: 2005+AC: 2005 EN 61204-3: 2000 EN55024:2010+A1: 2015			EN61000-4-2, EN61000-4-3, EN61000-4-4, EN61000-4-5, EN61000-4-6, EN61000-4-11, Heavy Industrial Level	
CE	EN61000-6-3, EN55032 Class B, EN61000-3-2, EN61000-3-3 EN61000-6-2, EN55024, EN61000-4-2 Level 4, EN61000-4-3 Level 3 EN61000-4-4 Level 4, EN61000-4-5 L-N Level 3, L / N-FG Level 4 EN61000-4-6 Level 3, EN61000-4-8 Level 4, EN691000-4-11 ENV 50204 Level 2, EN61204-3			EN55022, EN55024, FCC PART 15 CLASS B	EN55022, EN55024, FCC PART 15 CLASS B
UL Certification cULus cURus UL1310	UL508 Listed UL60950-1 (2nd Edition) Class 2		UL508 Listed UL60950-1 (2nd Edition) Class 2 only for 24VDC models (SPDM24751 and SPDM24751B)	UL508 Listed UL60950-1 (2nd Edition)	-
Vibration resistance	IEC 60068-2-6			IEC 60068-2-6	IEC 60068-2-6
Shock resistance	IEC 60068-2-27			IEC 60068-2-27	IEC 60068-2-27

## Insulation

	SPDM 30W	SPDM 50W	SPDM 75W	SPDM 120W	SPDM 240W
Insulation/Withstand Voltage (I/PE)	3000VAC / 4242VDC			3kVAC , ≤10mA	
Insulation/Withstand Voltage (I/O)	1500VAC / 2121VDC			1.5kVAC , ≤10mA	
Insulation/Withstand Voltage (O/PE)	500VAC / 710VDC			0.5kVAC , ≤10mA	
Insulation resistance	100MΩ Input-Output @ 500VDC			10MΩ	
Overvoltage Category	Level OVC II			II	
Pollution Degree	2				

## Input Data

	SPDM 30W	SPDM 50W	SPDM 75W	SPDM 120W	SPDM 240W
Rated Input Voltage	100VAC to 240VAC				
Input voltage range	85VAC to 264VAC 120VDC to 375VDC			90VAC to 264VAC 127VDC to 370VDC	
AC Current (max) 115VAC 230VAC	335mA 210mA	1000mA 500mA	1450mA 750mA	<2.7A <1.35A	<3A (24VDC), <3.5A (48VDC) <2.5A (24VDC), <2.5A (48VDC)
Frequency Range	47Hz to 63Hz				
Inrush current 115VAC 230VAC	<20A <40A	<30A <60A	<30A <60A	<20A <35A	<30A <60A
Inrush current (DC)	50A @ 375Vdc	70A @ 375Vdc	/		
Internal input fuse	T2A/250VAC	T2A/250VAC	T3.15A/250VAC	4A/250Vac	T6.3A/250V
Standby Power Consumption	0.3W		0.5W	<5W	

(All specifications are at nominal values, full load, 25°C unless otherwise stated)

## Output Data

	SPDM 30W	SPDM 50W	SPDM 75W	SPDM 120W	SPDM 240W
<b>Output Power</b>	30W	50W	75W	120W	240W
<b>Voltage accuracy</b>	±1%				
<b>Line Regulation</b>	±1%			±0.5%	
<b>Load Regulation</b>	±1%				
<b>Voltage regulation span</b>	11.4VDC to 15.6VDC (12VDC) 22.5VDC to 28.5VDC (24VDC)			12VDC to 14VDC (12VDC) 24VDC to 28VDC (24VDC) 48VDC to 56VDC (48VDC)	24VDC to 28VDC (24VDC) 48VDC to 56VDC (48VDC)
<b>Rated output current</b>	2A (12VDC) 1.25A (24VDC)	4A (12VDC) 2.1A (24VDC)	5.5A (12VDC) 3A (24VDC)	10A (12V) 5A (24V) 2.5A (48VDC)	10A (24V) 5A (48VDC)
<b>Ripple and Noise</b>	100mV			0 to 70°C (32 to 158°F) ≤120mV (12-24VDC) ≤240mV (48VDC) -20 to 0°C (-13 to 32°F) ≤240mV (12-24VDC) ≤480mV (48VDC)	0-70°C (32 to 158°F) ≤120mV (24VDC) ≤240mV (48VDC) (-20) -0°C (-13 to 32°F) ≤240mV (24VDC) ≤480mV (48VDC)
<b>Hold up Time</b> 115VAC 230VAC	20ms 50ms		15ms 50ms	≥10ms ≥20ms	≥10ms ≥20ms
<b>Set-up Time</b> 115VAC 230VAC	≤1s ≤1s		≤2s ≤2s	≤3ms ≤1.2s	≤2s
<b>Rise Time</b>	150ms			<60mS	<100mS
<b>Turn-on overshoot</b>	< +5%, lo nom, 25°C			<5.0%	
<b>Overshoot and Undershoot</b>	< +5%, lo nom, 25°C / < -5%, lo nom, 25°C			≤5.0%	
<b>Series Operation</b>	Yes				
<b>Parallel Operation</b>	No				
<b>Power Boost</b>	No				

(All specifications are at nominal values, full load, 25°C unless otherwise stated)

## Performance

### Current derating

#### SPDM 30W - 50W - 75W 12VDC / 24VDC

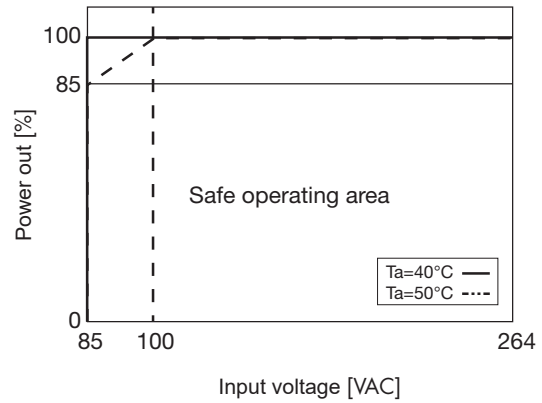
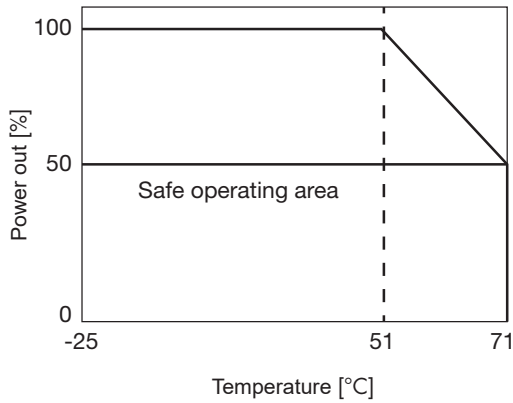

#### SPDM 120W 12VDC / 24VDC / 48VDC

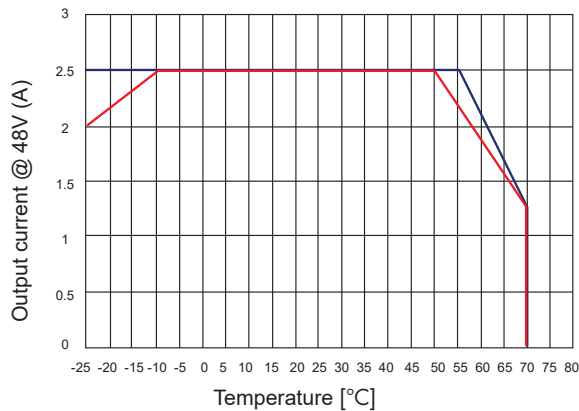
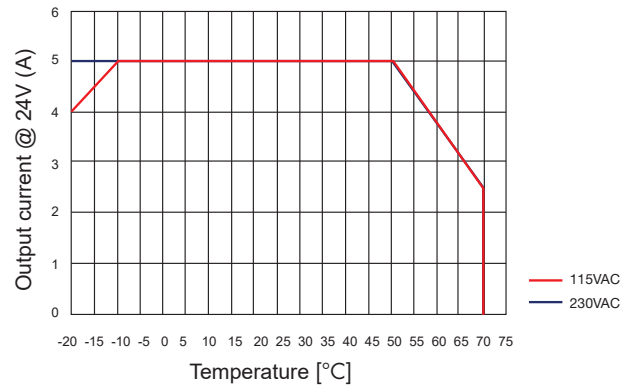
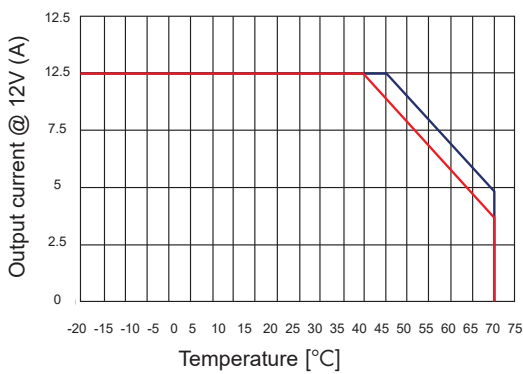

# SPDM



## SPDM 240W 24VDC / 48VDC

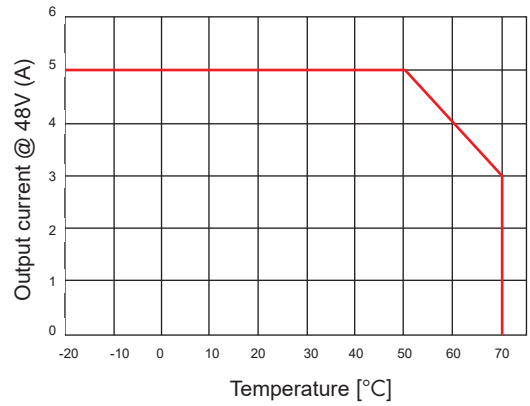
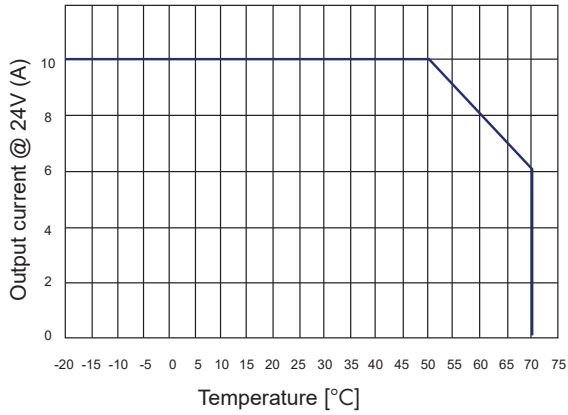

**Typ. current limited curve**

## SPDM 30W / 50W / 75W 12VDC / 24VDC

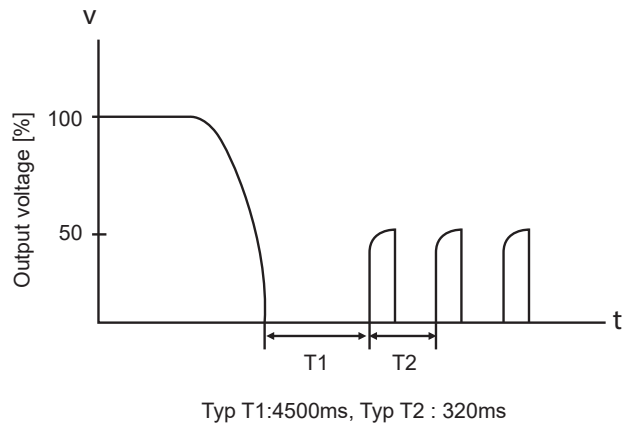
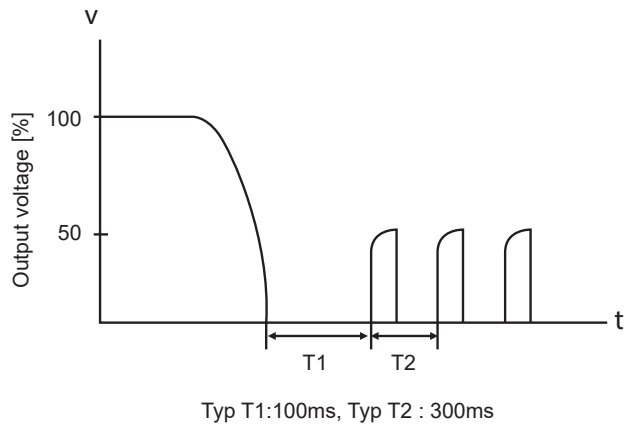

## SPDM 120W 12VDC / 24VDC / 48VDC

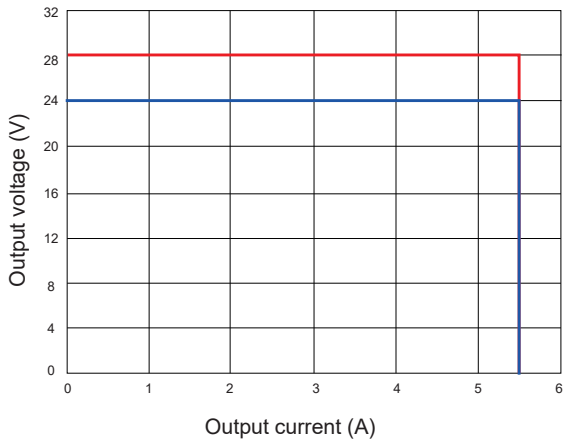

## SPDM 240W 24VDC / 48VDC

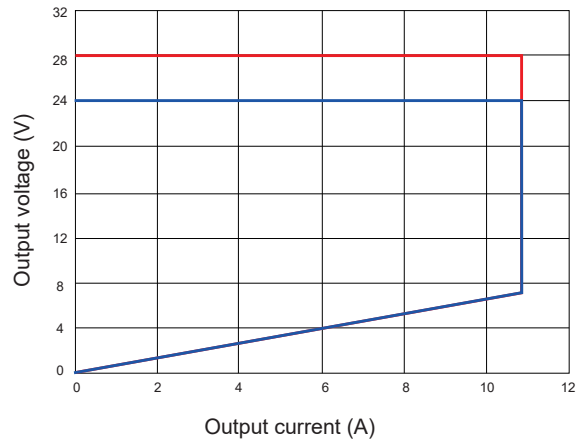



## Typ. efficiency curve

### SPDM 30W 12VDC / 24VDC

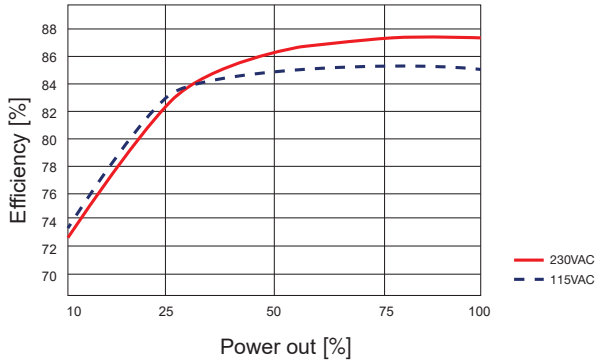

### SPDM 50W 12VDC / 24VDC

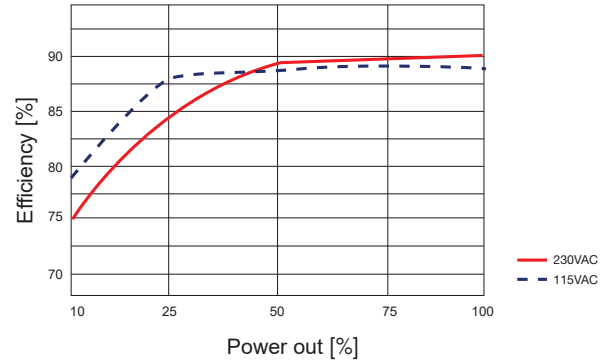

### SPDM 75W 12VDC / 24VDC

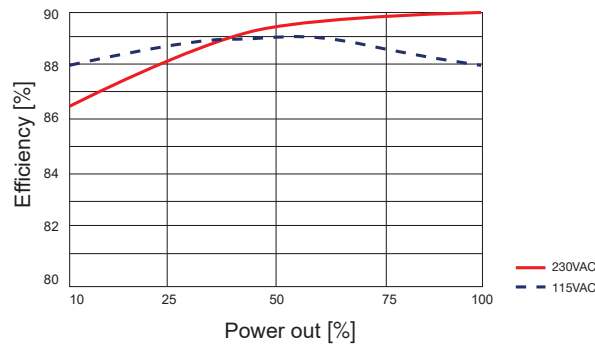

### SPDM 120W 12VDC / 24VDC / 48VDC

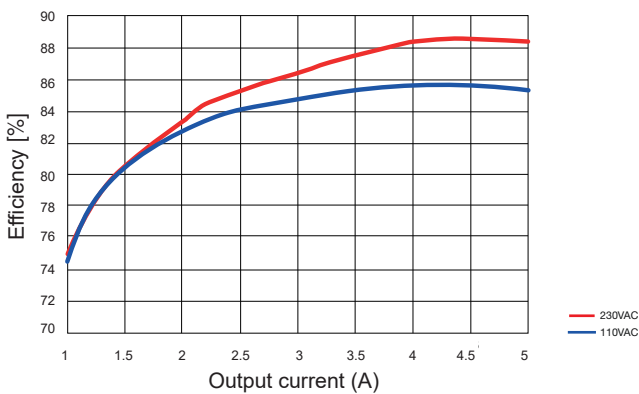

### SPDM 240W 24VDC / 48VDC

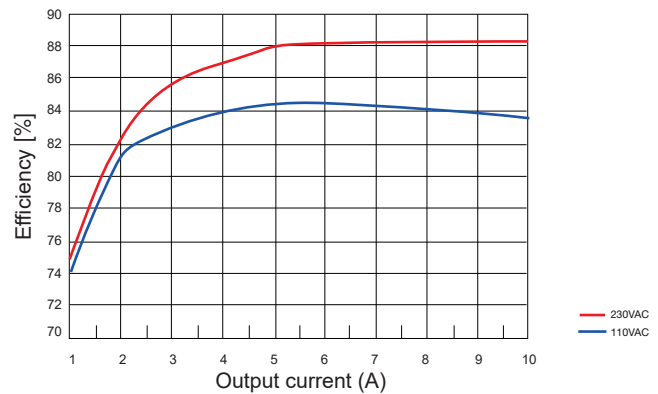

## Installation

	SPDM 30W	SPDM 50W	SPDM 75W	SPDM 120W	SPDM 240W
Ventilation and Cooling	Normal air convection; 25mm of free space on each side is recommended				

### SPDM 30W / 12VDC

Mounting A

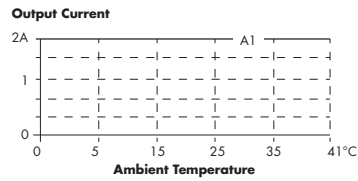
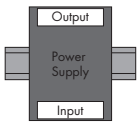

### SPDM 30W / 24VDC

Mounting A

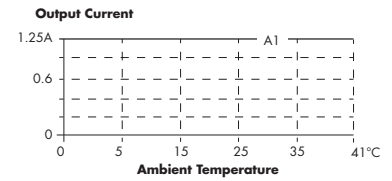
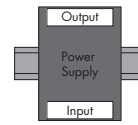

### SPDM 50W / 12VDC

Mounting A

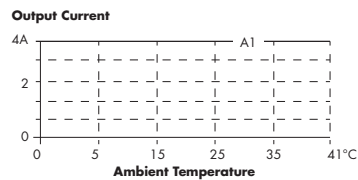
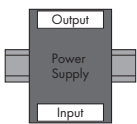

### SPDM 50W / 24VDC

Mounting A

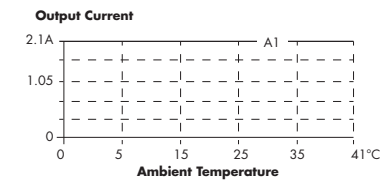
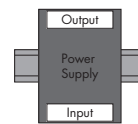

### SPDM 75W / 12VDC

Mounting A

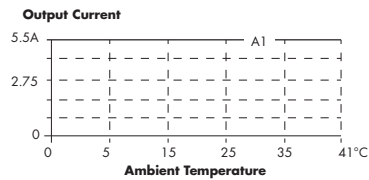
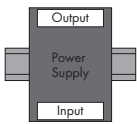

### SPDM 75W / 24VDC

Mounting A

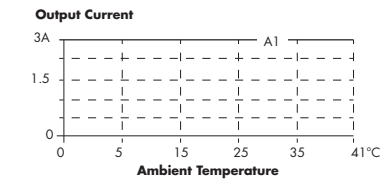
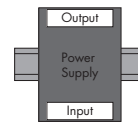

## SPDM 120W / 12VDC

## SPDM 120W / 24VDC

Mounting A

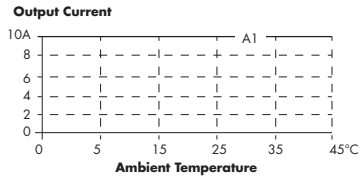
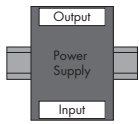

Mounting B

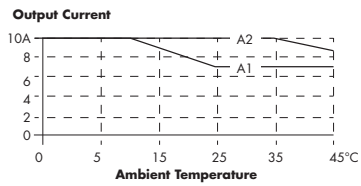
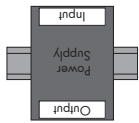

Mounting C

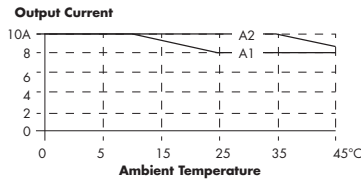
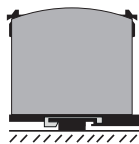

Mounting D

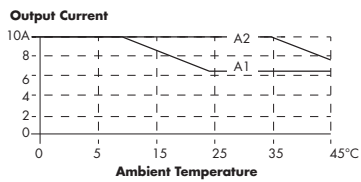
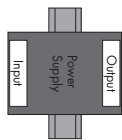

Mounting E

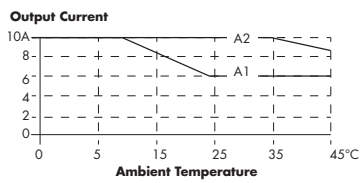
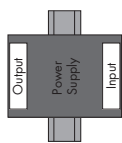

Mounting A

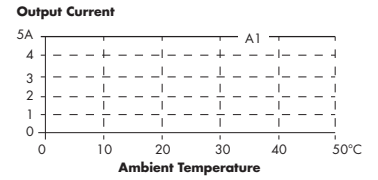
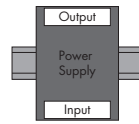

Mounting B

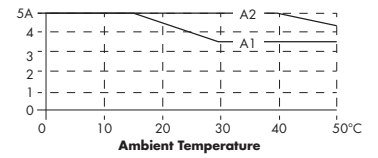
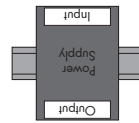

Mounting C

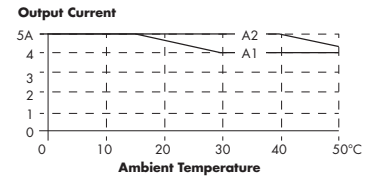
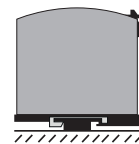

Mounting D

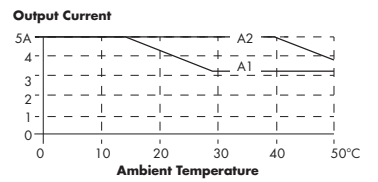
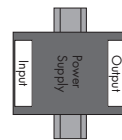

Mounting E

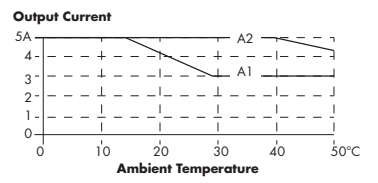
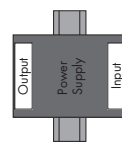

# SPDM



## SPDM 120W / 48VDC

**Mounting A**

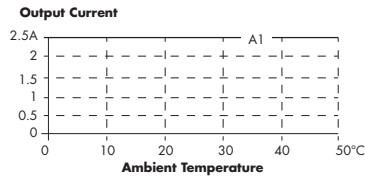
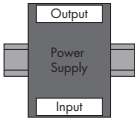

**Mounting B**

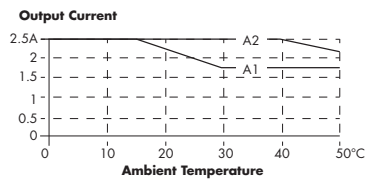
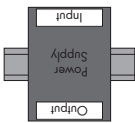

**Mounting C**

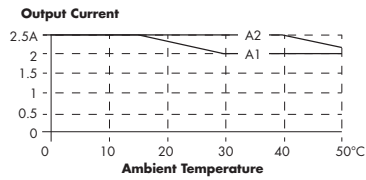
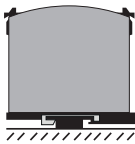

**Mounting D**

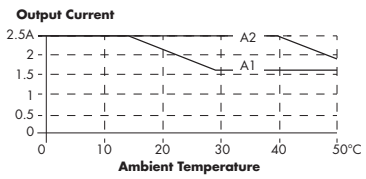
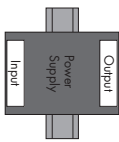

**Mounting E**

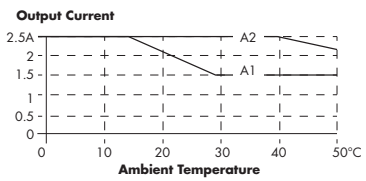
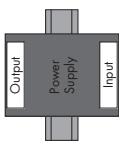

## SPDM 240W / 24VDC

## SPDM 240W / 48VDC

Mounting A

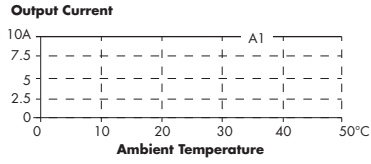
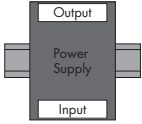

Mounting B

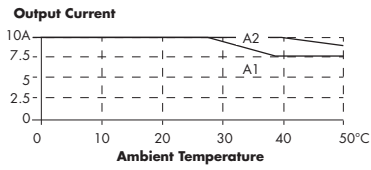
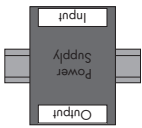

Mounting C

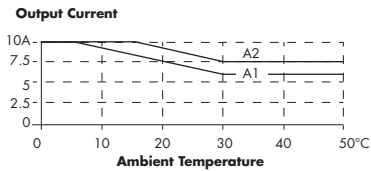
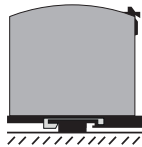

Mounting D

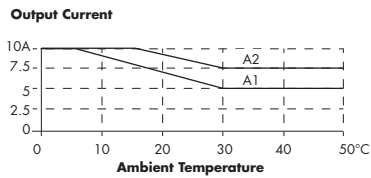
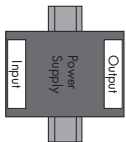

Mounting E

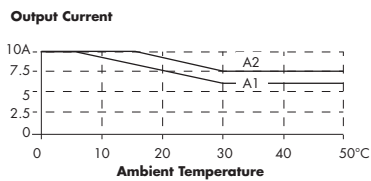
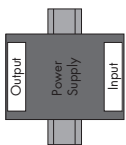

Mounting A

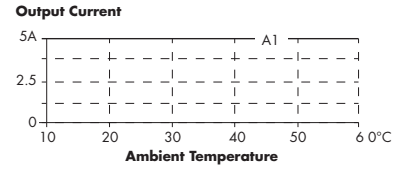
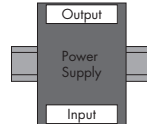

Mounting B

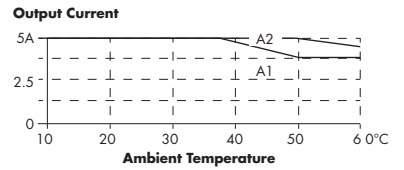
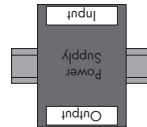

Mounting C

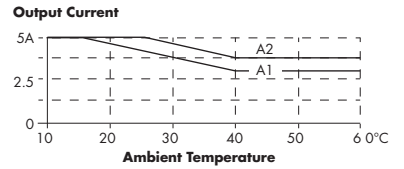
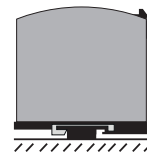

Mounting D

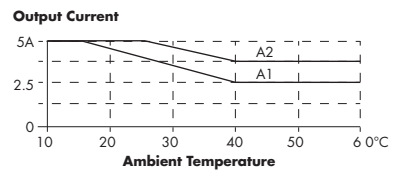
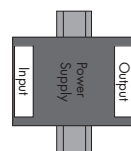

Mounting E

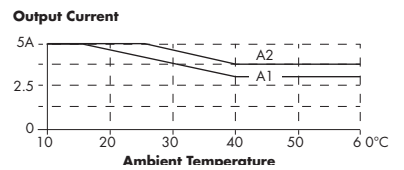
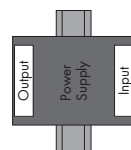

## ▶ Wiring diagram

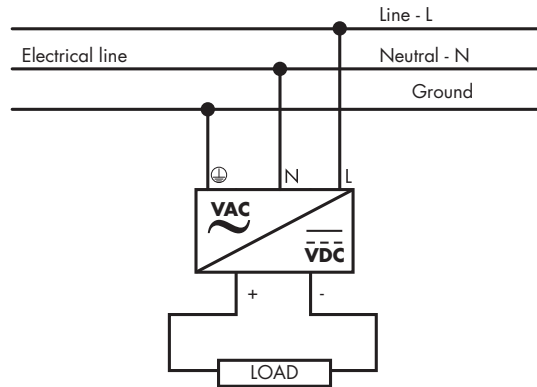

## ▶ Connection specification

	SPDM 30W	SPDM 50W	SPDM 75W	SPDM 120W	SPDM 240W
<b>Terminal type</b>	SCREW or SPRING Terminal Type			Input 6.35mm, 3pin screw terminals	
<b>Screw driver blade</b>	Philips 1 ( PH 1 )			3.5mm slotted or cross screwdriver	
<b>Tightening torque (Recommended)</b>	5Nm			5Nm	
<b>Flexible conductor Cross section Max</b>	2.5mm <sup>2</sup> (screw) 2.0mm <sup>2</sup> (spring)			4mm <sup>2</sup>	
<b>Flexible conductor Cross section Min</b>	0.2mm <sup>2</sup>			0.5mm <sup>2</sup>	
<b>Conductor Cross section AWG Max</b>	AWG26 (Screw) AWG 24 (Spring)			AWG20 (PG wire >18AWG)	
<b>Conductor Cross section AWG Min</b>	AWG12 (Screw) AWG 14 (Spring)			AWG10 (PG wire >18AWG)	
<b>Rigid conductor Cross-section Min</b>	2.5mm <sup>2</sup> (screw) 2.0mm <sup>2</sup> (spring)			6mm <sup>2</sup>	
<b>Rigid conductor Cross-section Max</b>	0.2mm <sup>2</sup>			0.5mm <sup>2</sup>	
<b>Max Wire Diameter</b>	Spring terminal: AWG24-14 (0.2~ 2mm <sup>2</sup> ) Screw terminal: AWG26-12 (0.2~2.5mm <sup>2</sup> )			2.8mm <sup>2</sup>	

## Block diagram

### SPDM 30W / 50W / 75W

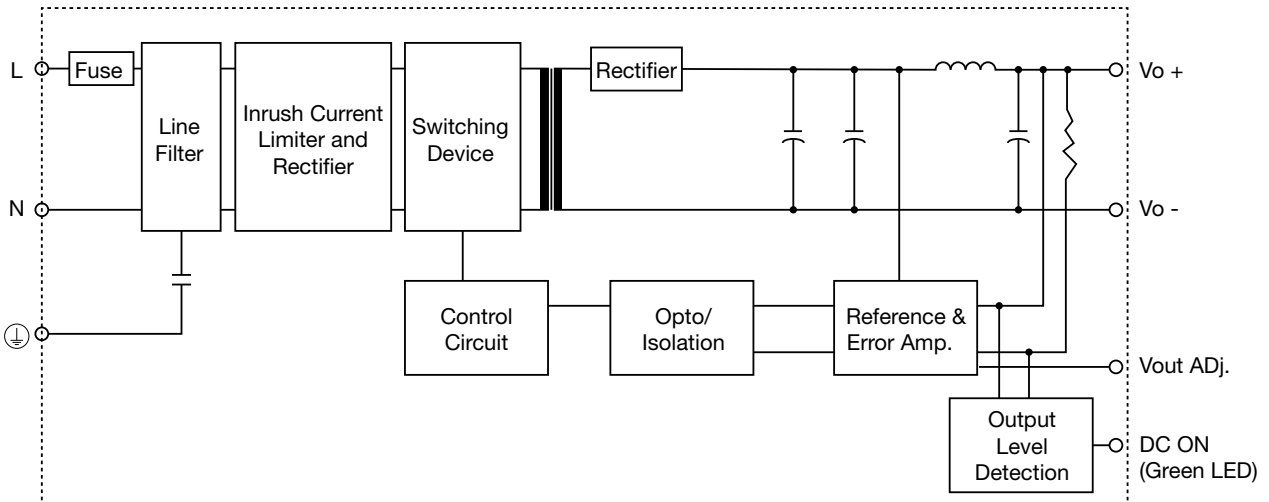

### SPDM 120W / 240W

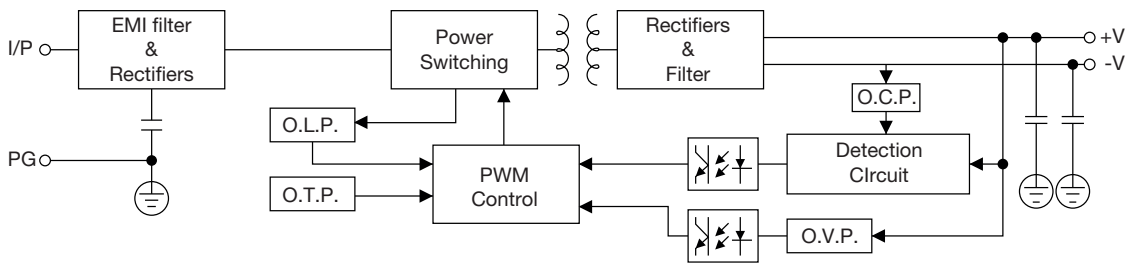

## Troubleshooting

### ▶ Signaling and controls

	SPDM 30W	SPDM 50W	SPDM 75W	SPDM 120W	SPDM 240W
DC OK LED	Green				
DC OK output type	No				
OK threshold	9.6VDC to 10.8VDC (12VDC) 19.2 VDCto 21.6VDC (24VDC)			/	/

## Operating description

### ▶ Control and protection

	SPDM 30W	SPDM 50W	SPDM 75W	SPDM 120W	SPDM 240W
Overvoltage protection	16-18VDC (12VDC) 28.8-32.4VDC (24VDC)			15-18VDC (12VDC) 29-33VDC (24VDC) 58-63VDC (48VDC)	28-35VDC (24VDC) 58-63VDC (48VDC)
Overload protection	140%			10.5-13A (12VDC) 5.25-13A (24VDC) 2.75-3.25A (48VDC)	10.3-11.5A (24VDC) 5.55-6.5A (48VDC)
Current Limiting	/			/	/
Short Circuit protection	Hiccup mode			Long-term mode, auto recovery	
Over temperature protection	-			100±5°C, detect on heat sink of power transistor; shut down O/P, re-power on	
Internal voltage surge protection	Varistor			NTC	
Reverse voltage protection	No				



## Glossary



**CE:** "Conformité Européene" or "European Conformity" ; Indicates the manufacturer declaration of conformity that the product meets the relevant health, safety and environmental protection requirements of the applicable EC directives.



**cULus:** This certification mark is based on the UL508 ; Standard for Industrial Control Equipment. The UL508 covers industrial control devices and devices accessory for starting, stopping, regulating, controlling, or protecting electric motors. In addition, UL508 also covers devices rated 1500 volts or less. Industrial control equipment covered by these requirements is intended for use in an ambient temperature of 0 – 40°C (32 – 104°F).



**UL1310:** The UL1310 Class 2 units utilize an isolating transformer and may incorporate components to provide an alternating- or direct-current output. Each output provides Class 2 power levels in accordance with the National Electrical Code, ANSI/NFPA 70. Maximum output voltage does not exceed 42.4 V peak for alternating current, 60 V for continuous direct current. These products are intended primarily to provide power to low voltage, electrically operated devices.



**cRUus:** This certification mark is based on the UL60950-1 ; Information Technology Equipment - Safety - Part 1. The UL60950-1 is applicable to mains-powered or battery-powered information technology equipment, including electrical business equipment and associated equipment, with a RATED VOLTAGE not exceeding 600 V.



**Economical:** The SPDM is the most economical power supply, offering features and space saving while lowering the cost.



**Spring Terminals:** The SPDM 30W, 50W and 75W provide the option of spring terminals, saving installation time by up to 50%.



**Reduced dimension:** The footprint is reduced with the SPDM, saving up to 30% space when compared to others.