

EFM[®]32

... the world's most energy friendly microcontrollers

EFM32HG308 DATASHEET

F64/F32

- **ARM Cortex-M0+ CPU platform**
 - High Performance 32-bit processor @ up to 25 MHz
 - Wake-up Interrupt Controller
- **Flexible Energy Management System**
 - 20 nA @ 3 V Shutoff Mode
 - 0.6 μ A @ 3 V Stop Mode, including Power-on Reset, Brown-out Detector, RAM and CPU retention
 - 0.9 μ A @ 3 V Deep Sleep Mode, including RTC with 32.768 kHz oscillator, Power-on Reset, Brown-out Detector, RAM and CPU retention
 - 51 μ A/MHz @ 3 V Sleep Mode
 - 127 μ A/MHz @ 3 V Run Mode, with code executed from flash
- **64/32 KB Flash**
- **8/8 KB RAM**
- **15 General Purpose I/O pins**
 - Configurable push-pull, open-drain, pull-up/down, input filter, drive strength
 - Configurable peripheral I/O locations
 - 10 asynchronous external interrupts
 - Output state retention and wake-up from Shutoff Mode
- **6 Channel DMA Controller**
- **6 Channel Peripheral Reflex System (PRS) for autonomous inter-peripheral signaling**
- **Timers/Counters**
 - 3 \times 16-bit Timer/Counter
 - 3 \times 3 Compare/Capture/PWM channels
 - Dead-Time Insertion on TIMER0
 - 1 \times 24-bit Real-Time Counter
 - 1 \times 16-bit Pulse Counter
 - Watchdog Timer with dedicated RC oscillator @ 50 nA
- **Communication interfaces**
 - 2 \times Universal Synchronous/Asynchronous Receiver/Transmitter
 - UART/SPI/SmartCard (ISO 7816)/IrDA/I2S
 - Triple buffered full/half-duplex operation
 - Low Energy UART
 - Autonomous operation with DMA in Deep Sleep Mode
 - I²C Interface with SMBus support
 - Address recognition in Stop Mode
 - Low Energy Universal Serial Bus (USB) Device
 - Fully USB 2.0 compliant
 - On-chip PHY and embedded 5V to 3.3V regulator
 - Crystal-free operation
- **Ultra low power precision analog peripherals**
 - 1 \times Analog Comparator
 - Capacitive sensing with up to 2 inputs
 - Supply Voltage Comparator
- **Ultra efficient Power-on Reset and Brown-Out Detector**
- **Debug Interface**
 - 2-pin Serial Wire Debug interface
 - Micro Trace Buffer (MTB)
- **Pre-Programmed USB/UART Bootloader**
- **Temperature range -40 to 85 °C**
- **Single power supply 1.98 to 3.8 V**
- **QFN24 package**

32-bit ARM Cortex-M0+, Cortex-M3 and Cortex-M4 microcontrollers for:

- Energy, gas, water and smart metering
- Health and fitness applications
- Smart accessories
- Alarm and security systems
- Industrial and home automation



1 Ordering Information

Table 1.1 (p. 2) shows the available EFM32HG308 devices.

Table 1.1. Ordering Information

Ordering Code	Flash (kB)	RAM (kB)	Max Speed (MHz)	Supply Voltage (V)	Temperature (°C)	Package
EFM32HG308F32G-B-QFN24	32	8	25	1.98 - 3.8	-40 - 85	QFN24
EFM32HG308F64G-B-QFN24	64	8	25	1.98 - 3.8	-40 - 85	QFN24

Adding the suffix 'R' to the part number (e.g. EFM32HG308F32G-B-QFN24R) denotes tape and reel.

Visit www.silabs.com for information on global distributors and representatives.

2 System Summary

2.1 System Introduction

The EFM32 MCUs are the world's most energy friendly microcontrollers. With a unique combination of the powerful 32-bit ARM Cortex-M0+, innovative low energy techniques, short wake-up time from energy saving modes, and a wide selection of peripherals, the EFM32HG microcontroller is well suited for any battery operated application as well as other systems requiring high performance and low-energy consumption. This section gives a short introduction to each of the modules in general terms and also shows a summary of the configuration for the EFM32HG308 devices. For a complete feature set and in-depth information on the modules, the reader is referred to the *EFM32HG Reference Manual*.

A block diagram of the EFM32HG308 is shown in Figure 2.1 (p. 3) .

Figure 2.1. Block Diagram

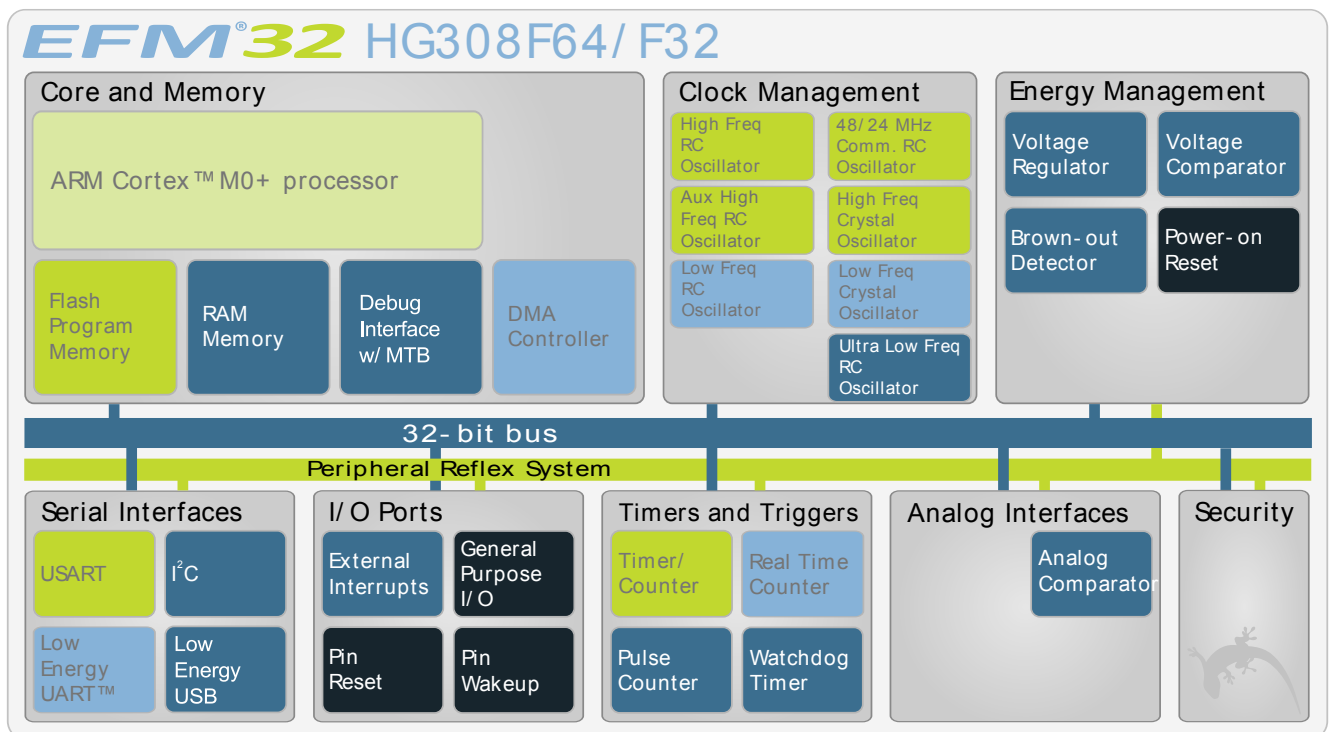

2.1.1 ARM Cortex-M0+ Core

The ARM Cortex-M0+ includes a 32-bit RISC processor which can achieve as much as 0.9 Dhrystone MIPS/MHz. A Wake-up Interrupt Controller handling interrupts triggered while the CPU is asleep is included as well. The EFM32 implementation of the Cortex-M0+ is described in detail in *ARM Cortex-M0+ Devices Generic User Guide*.

2.1.2 Debug Interface (DBG)

This device includes hardware debug support through a 2-pin serial-wire debug interface and a Micro Trace Buffer (MTB) for data/instruction tracing.

2.1.3 Memory System Controller (MSC)

The Memory System Controller (MSC) is the program memory unit of the EFM32HG microcontroller. The flash memory is readable and writable from both the Cortex-M0+ and DMA. The flash memory is

divided into two blocks; the main block and the information block. Program code is normally written to the main block. Additionally, the information block is available for special user data and flash lock bits. There is also a read-only page in the information block containing system and device calibration data. Read and write operations are supported in the energy modes EM0 and EM1.

2.1.4 Direct Memory Access Controller (DMA)

The Direct Memory Access (DMA) controller performs memory operations independently of the CPU. This has the benefit of reducing the energy consumption and the workload of the CPU, and enables the system to stay in low energy modes when moving for instance data from the USART to RAM or from the External Bus Interface to a PWM-generating timer. The DMA controller uses the PL230 μ DMA controller licensed from ARM.

2.1.5 Reset Management Unit (RMU)

The RMU is responsible for handling the reset functionality of the EFM32HG.

2.1.6 Energy Management Unit (EMU)

The Energy Management Unit (EMU) manage all the low energy modes (EM) in EFM32HG microcontrollers. Each energy mode manages if the CPU and the various peripherals are available. The EMU can also be used to turn off the power to unused SRAM blocks.

2.1.7 Clock Management Unit (CMU)

The Clock Management Unit (CMU) is responsible for controlling the oscillators and clocks on-board the EFM32HG. The CMU provides the capability to turn on and off the clock on an individual basis to all peripheral modules in addition to enable/disable and configure the available oscillators. The high degree of flexibility enables software to minimize energy consumption in any specific application by not wasting power on peripherals and oscillators that are inactive.

2.1.8 Watchdog (WDOG)

The purpose of the watchdog timer is to generate a reset in case of a system failure, to increase application reliability. The failure may e.g. be caused by an external event, such as an ESD pulse, or by a software failure.

2.1.9 Peripheral Reflex System (PRS)

The Peripheral Reflex System (PRS) system is a network which lets the different peripheral module communicate directly with each other without involving the CPU. Peripheral modules which send out Reflex signals are called producers. The PRS routes these reflex signals to consumer peripherals which apply actions depending on the data received. The format for the Reflex signals is not given, but edge triggers and other functionality can be applied by the PRS.

2.1.10 Low Energy USB

The unique Low Energy USB peripheral provides a full-speed USB 2.0 compliant device controller and PHY with ultra-low current consumption. The device supports both full-speed (12MBit/s) and low speed (1.5MBit/s) operation, and includes a dedicated USB oscillator with clock recovery mechanism for crystal-free operation. No external components are required. The Low Energy Mode ensures the current consumption is optimized and enables USB communication on a strict power budget. The USB device includes an internal dedicated descriptor-based Scatter/Gather DMA and supports up to 3 OUT endpoints and 3 IN endpoints, in addition to endpoint 0. The on-chip PHY includes software controllable pull-up and pull-down resistors.

2.1.11 Inter-Integrated Circuit Interface (I2C)

The I²C module provides an interface between the MCU and a serial I²C-bus. It is capable of acting as both a master and a slave, and supports multi-master buses. Both standard-mode, fast-mode and fast-mode plus speeds are supported, allowing transmission rates all the way from 10 kbit/s up to 1 Mbit/s. Slave arbitration and timeouts are also provided to allow implementation of an SMBus compliant system. The interface provided to software by the I²C module, allows both fine-grained control of the transmission process and close to automatic transfers. Automatic recognition of slave addresses is provided in all energy modes.

2.1.12 Universal Synchronous/Asynchronous Receiver/Transmitter (USART)

The Universal Synchronous Asynchronous serial Receiver and Transmitter (USART) is a very flexible serial I/O module. It supports full duplex asynchronous UART communication as well as RS-485, SPI, MicroWire and 3-wire. It can also interface with ISO7816 SmartCards, IrDA and I2S devices.

2.1.13 Pre-Programmed USB/UART Bootloader

The bootloader presented in application note AN0042 is pre-programmed in the device at factory. The bootloader enables users to program the EFM32 through a UART or a USB CDC class virtual UART without the need for a debugger. The autobaud feature, interface and commands are described further in the application note.

2.1.14 Low Energy Universal Asynchronous Receiver/Transmitter (LEUART)

The unique LEUART[™], the Low Energy UART, is a UART that allows two-way UART communication on a strict power budget. Only a 32.768 kHz clock is needed to allow UART communication up to 9600 baud/s. The LEUART includes all necessary hardware support to make asynchronous serial communication possible with minimum of software intervention and energy consumption.

2.1.15 Timer/Counter (TIMER)

The 16-bit general purpose Timer has 3 compare/capture channels for input capture and compare/Pulse-Width Modulation (PWM) output. TIMER0 also includes a Dead-Time Insertion module suitable for motor control applications.

2.1.16 Real Time Counter (RTC)

The Real Time Counter (RTC) contains a 24-bit counter and is clocked either by a 32.768 kHz crystal oscillator, or a 32.768 kHz RC oscillator. In addition to energy modes EM0 and EM1, the RTC is also available in EM2. This makes it ideal for keeping track of time since the RTC is enabled in EM2 where most of the device is powered down.

2.1.17 Pulse Counter (PCNT)

The Pulse Counter (PCNT) can be used for counting pulses on a single input or to decode quadrature encoded inputs. It runs off either the internal LFACLK or the PCNTn_S0IN pin as external clock source. The module may operate in energy mode EM0 - EM3.

2.1.18 Analog Comparator (ACMP)

The Analog Comparator is used to compare the voltage of two analog inputs, with a digital output indicating which input voltage is higher. Inputs can either be one of the selectable internal references or from

external pins. Response time and thereby also the current consumption can be configured by altering the current supply to the comparator.

2.1.19 Voltage Comparator (VCMP)

The Voltage Supply Comparator is used to monitor the supply voltage from software. An interrupt can be generated when the supply falls below or rises above a programmable threshold. Response time and thereby also the current consumption can be configured by altering the current supply to the comparator.

2.1.20 General Purpose Input/Output (GPIO)

In the EFM32HG308, there are 15 General Purpose Input/Output (GPIO) pins, which are divided into ports with up to 16 pins each. These pins can individually be configured as either an output or input. More advanced configurations like open-drain, filtering and drive strength can also be configured individually for the pins. The GPIO pins can also be overridden by peripheral pin connections, like Timer PWM outputs or USART communication, which can be routed to several locations on the device. The GPIO supports up to 10 asynchronous external pin interrupts, which enables interrupts from any pin on the device. Also, the input value of a pin can be routed through the Peripheral Reflex System to other peripherals.

2.2 Configuration Summary

The features of the EFM32HG308 is a subset of the feature set described in the EFM32HG Reference Manual. Table 2.1 (p. 6) describes device specific implementation of the features.

Table 2.1. Configuration Summary

Module	Configuration	Pin Connections
Cortex-M0+	Full configuration	NA
DBG	Full configuration	DBG_SWCLK, DBG_SWDIO,
MSC	Full configuration	NA
DMA	Full configuration	NA
RMU	Full configuration	NA
EMU	Full configuration	NA
CMU	Full configuration	CMU_OUT0, CMU_OUT1
WDOG	Full configuration	NA
PRS	Full configuration	NA
USB	Full configuration	USB_VREGI, USB_VREGO, USB_DM, USB_DMPU, USB_DP
I2C0	Full configuration	I2C0_SDA, I2C0_SCL
USART0	Full configuration with IrDA and I2S	US0_TX, US0_RX, US0_CLK, US0_CS
USART1	Full configuration with I2S and IrDA	US1_TX, US1_RX, US1_CLK, US1_CS
LEUART0	Full configuration	LEU0_TX, LEU0_RX
TIMER0	Full configuration with DTI	TIM0_CC[2:0], TIM0_CDTI[2:0]
TIMER1	Full configuration	TIM1_CC[2:0]
TIMER2	Full configuration	TIM2_CC[2:0]
RTC	Full configuration	NA
PCNT0	Full configuration, 16-bit count register	PCNT0_S[1:0]

Module	Configuration	Pin Connections
ACMP0	Full configuration	ACMP0_CH[1:0], ACMP0_O
VCMP	Full configuration	NA
GPIO	15 pins	Available pins are shown in Table 4.3 (p. 42)

2.3 Memory Map

The EFM32HG308 memory map is shown in Figure 2.2 (p. 7), with RAM and Flash sizes for the largest memory configuration.

Figure 2.2. EFM32HG308 Memory Map with largest RAM and Flash sizes

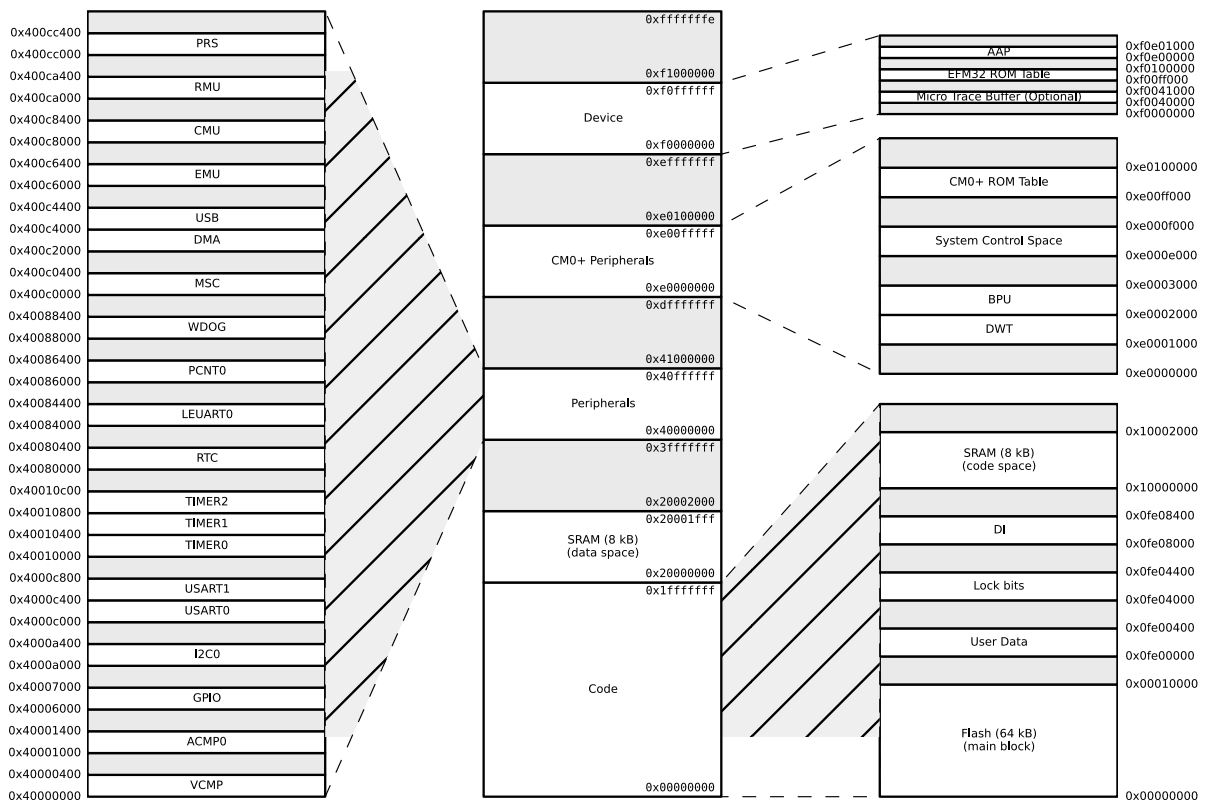

3 Electrical Characteristics

3.1 Test Conditions

3.1.1 Typical Values

The typical data are based on $T_{AMB}=25^{\circ}\text{C}$ and $V_{DD}=3.0\text{ V}$, as defined in Table 3.2 (p. 8), unless otherwise specified.

3.1.2 Minimum and Maximum Values

The minimum and maximum values represent the worst conditions of ambient temperature, supply voltage and frequencies, as defined in Table 3.2 (p. 8), unless otherwise specified.

3.2 Absolute Maximum Ratings

The absolute maximum ratings are stress ratings, and functional operation under such conditions are not guaranteed. Stress beyond the limits specified in Table 3.1 (p. 8) may affect the device reliability or cause permanent damage to the device. Functional operating conditions are given in Table 3.2 (p. 8).

Table 3.1. Absolute Maximum Ratings

Symbol	Parameter	Condition	Min	Typ	Max	Unit
T_{STG}	Storage temperature range		-40		150 ¹	$^{\circ}\text{C}$
T_S	Maximum soldering temperature	Latest IPC/JEDEC J-STD-020 Standard			260	$^{\circ}\text{C}$
V_{DDMAX}	External main supply voltage		0		3.8	V
V_{IOPIN}	Voltage on any I/O pin		-0.3		$V_{DD}+0.3$	V

¹Based on programmed devices tested for 10000 hours at 150°C. Storage temperature affects retention of preprogrammed calibration values stored in flash. Please refer to the Flash section in the Electrical Characteristics for information on flash data retention for different temperatures.

3.3 General Operating Conditions

3.3.1 General Operating Conditions

Table 3.2. General Operating Conditions

Symbol	Parameter	Min	Typ	Max	Unit
T_{AMB}	Ambient temperature range	-40		85	$^{\circ}\text{C}$
V_{DDOP}	Operating supply voltage	1.98		3.8	V
f_{APB}	Internal APB clock frequency			25	MHz
f_{AHB}	Internal AHB clock frequency			25	MHz

3.4 Current Consumption

Table 3.3. Current Consumption

Symbol	Parameter	Condition	Min	Typ	Max	Unit
I_{EM0}	EM0 current. No prescaling. Running prime number calculation code from Flash.	24 MHz HFXO, all peripheral clocks disabled, $V_{DD}=3.0\text{ V}$, $T_{AMB}=25^{\circ}\text{C}$		148	158	$\mu\text{A}/\text{MHz}$
		24 MHz HFXO, all peripheral clocks disabled, $V_{DD}=3.0\text{ V}$, $T_{AMB}=85^{\circ}\text{C}$		153	163	$\mu\text{A}/\text{MHz}$
		24 MHz USHFRCO, all peripheral clocks disabled, $V_{DD}=3.0\text{ V}$, $T_{AMB}=25^{\circ}\text{C}$		161	172	$\mu\text{A}/\text{MHz}$
		24 MHz USHFRCO, all peripheral clocks disabled, $V_{DD}=3.0\text{ V}$, $T_{AMB}=85^{\circ}\text{C}$		163	174	$\mu\text{A}/\text{MHz}$
		24 MHz HFRCO, all peripheral clocks disabled, $V_{DD}=3.0\text{ V}$, $T_{AMB}=25^{\circ}\text{C}$		127	137	$\mu\text{A}/\text{MHz}$
		24 MHz HFRCO, all peripheral clocks disabled, $V_{DD}=3.0\text{ V}$, $T_{AMB}=85^{\circ}\text{C}$		129	139	$\mu\text{A}/\text{MHz}$
		21 MHz HFRCO, all peripheral clocks disabled, $V_{DD}=3.0\text{ V}$, $T_{AMB}=25^{\circ}\text{C}$		131	140	$\mu\text{A}/\text{MHz}$
		21 MHz HFRCO, all peripheral clocks disabled, $V_{DD}=3.0\text{ V}$, $T_{AMB}=85^{\circ}\text{C}$		134	143	$\mu\text{A}/\text{MHz}$
		14 MHz HFRCO, all peripheral clocks disabled, $V_{DD}=3.0\text{ V}$, $T_{AMB}=25^{\circ}\text{C}$		134	143	$\mu\text{A}/\text{MHz}$
		14 MHz HFRCO, all peripheral clocks disabled, $V_{DD}=3.0\text{ V}$, $T_{AMB}=85^{\circ}\text{C}$		137	145	$\mu\text{A}/\text{MHz}$
		11 MHz HFRCO, all peripheral clocks disabled, $V_{DD}=3.0\text{ V}$, $T_{AMB}=25^{\circ}\text{C}$		136	144	$\mu\text{A}/\text{MHz}$
		11 MHz HFRCO, all peripheral clocks disabled, $V_{DD}=3.0\text{ V}$, $T_{AMB}=85^{\circ}\text{C}$		139	148	$\mu\text{A}/\text{MHz}$
		6.6 MHz HFRCO, all peripheral clocks disabled, $V_{DD}=3.0\text{ V}$, $T_{AMB}=25^{\circ}\text{C}$		142	150	$\mu\text{A}/\text{MHz}$
		6.6 MHz HFRCO, all peripheral clocks disabled, $V_{DD}=3.0\text{ V}$, $T_{AMB}=85^{\circ}\text{C}$		146	154	$\mu\text{A}/\text{MHz}$
		1.2 MHz HFRCO, all peripheral clocks disabled, $V_{DD}=3.0\text{ V}$, $T_{AMB}=25^{\circ}\text{C}$		184	196	$\mu\text{A}/\text{MHz}$
1.2 MHz HFRCO, all peripheral clocks disabled, $V_{DD}=3.0\text{ V}$, $T_{AMB}=85^{\circ}\text{C}$		194	208	$\mu\text{A}/\text{MHz}$		

Symbol	Parameter	Condition	Min	Typ	Max	Unit
I _{EM1}	EM1 current	24 MHz HFXO, all peripheral clocks disabled, V _{DD} = 3.0 V, T _{AMB} =25°C		64	68	µA/ MHz
		24 MHz HFXO, all peripheral clocks disabled, V _{DD} = 3.0 V, T _{AMB} =85°C		67	71	µA/ MHz
		24 MHz USHFRCO, all peripheral clocks disabled, V _{DD} = 3.0 V, T _{AMB} =25°C		85	91	µA/ MHz
		24 MHz USHFRCO, all peripheral clocks disabled, V _{DD} = 3.0 V, T _{AMB} =85°C		86	92	µA/ MHz
		24 MHz HFRCO, all peripheral clocks disabled, V _{DD} = 3.0 V, T _{AMB} =25°C		51	55	µA/ MHz
		24 MHz HFRCO, all peripheral clocks disabled, V _{DD} = 3.0 V, T _{AMB} =85°C		52	56	µA/ MHz
		21 MHz HFRCO, all peripheral clocks disabled, V _{DD} = 3.0 V, T _{AMB} =25°C		53	57	µA/ MHz
		21 MHz HFRCO, all peripheral clocks disabled, V _{DD} = 3.0 V, T _{AMB} =85°C		54	58	µA/ MHz
		14 MHz HFRCO, all peripheral clocks disabled, V _{DD} = 3.0 V, T _{AMB} =25°C		56	59	µA/ MHz
		14 MHz HFRCO, all peripheral clocks disabled, V _{DD} = 3.0 V, T _{AMB} =85°C		57	61	µA/ MHz
		11 MHz HFRCO, all peripheral clocks disabled, V _{DD} = 3.0 V, T _{AMB} =25°C		58	61	µA/ MHz
		11 MHz HFRCO, all peripheral clocks disabled, V _{DD} = 3.0 V, T _{AMB} =85°C		59	63	µA/ MHz
		6.6 MHz HFRCO, all peripheral clocks disabled, V _{DD} = 3.0 V, T _{AMB} =25°C		64	68	µA/ MHz
		6.6 MHz HFRCO, all peripheral clocks disabled, V _{DD} = 3.0 V, T _{AMB} =85°C		67	71	µA/ MHz
		1.2 MHz HFRCO. all peripheral clocks disabled, V _{DD} = 3.0 V, T _{AMB} =25°C		106	114	µA/ MHz
1.2 MHz HFRCO. all peripheral clocks disabled, V _{DD} = 3.0 V, T _{AMB} =85°C		114	126	µA/ MHz		
I _{EM2}	EM2 current	EM2 current with RTC prescaled to 1 Hz, 32.768 kHz LFRCO, V _{DD} = 3.0 V, T _{AMB} =25°C		0.9	1.35	µA

Symbol	Parameter	Condition	Min	Typ	Max	Unit
		EM2 current with RTC prescaled to 1 Hz, 32.768 kHz LFRCO, V _{DD} = 3.0 V, T _{AMB} =85°C		1.6	3.50	µA
I _{EM3}	EM3 current	EM3 current (ULFRCO enabled, LFRCO/LFXO disabled), V _{DD} = 3.0 V, T _{AMB} =25°C		0.6	0.90	µA
		EM3 current (ULFRCO enabled, LFRCO/LFXO disabled), V _{DD} = 3.0 V, T _{AMB} =85°C		1.2	2.65	µA
I _{EM4}	EM4 current	V _{DD} = 3.0 V, T _{AMB} =25°C		0.02	0.035	µA
		V _{DD} = 3.0 V, T _{AMB} =85°C		0.18	0.480	µA

3.4.1 EM0 Current Consumption

Figure 3.1. EM0 Current consumption while executing prime number calculation code from flash with HFRCO running at 24 MHz

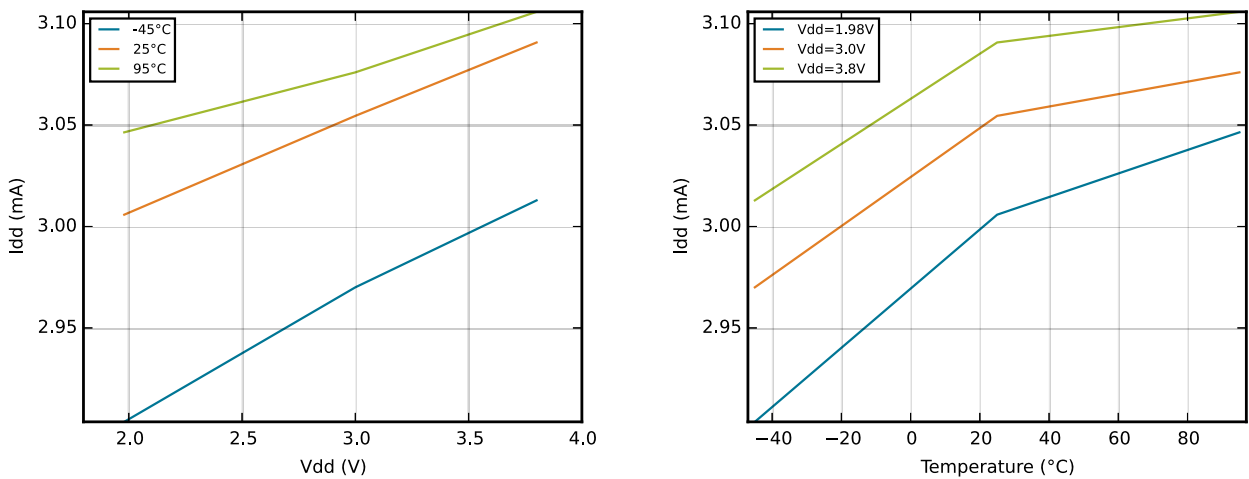

Figure 3.2. EM0 Current consumption while executing prime number calculation code from flash with HFRCO running at 21 MHz

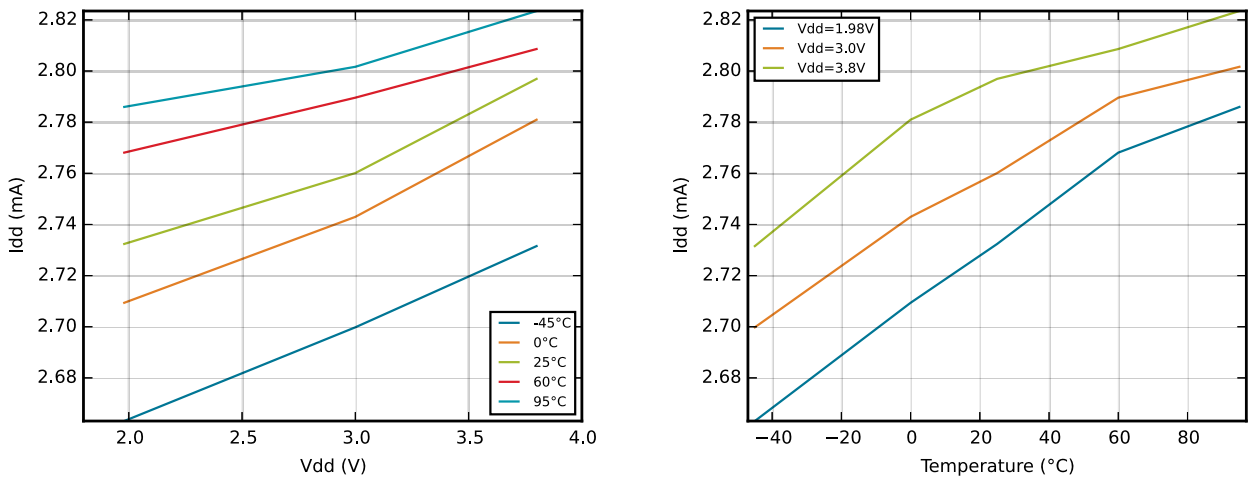

Figure 3.3. EM0 Current consumption while executing prime number calculation code from flash with HFRCO running at 14 MHz

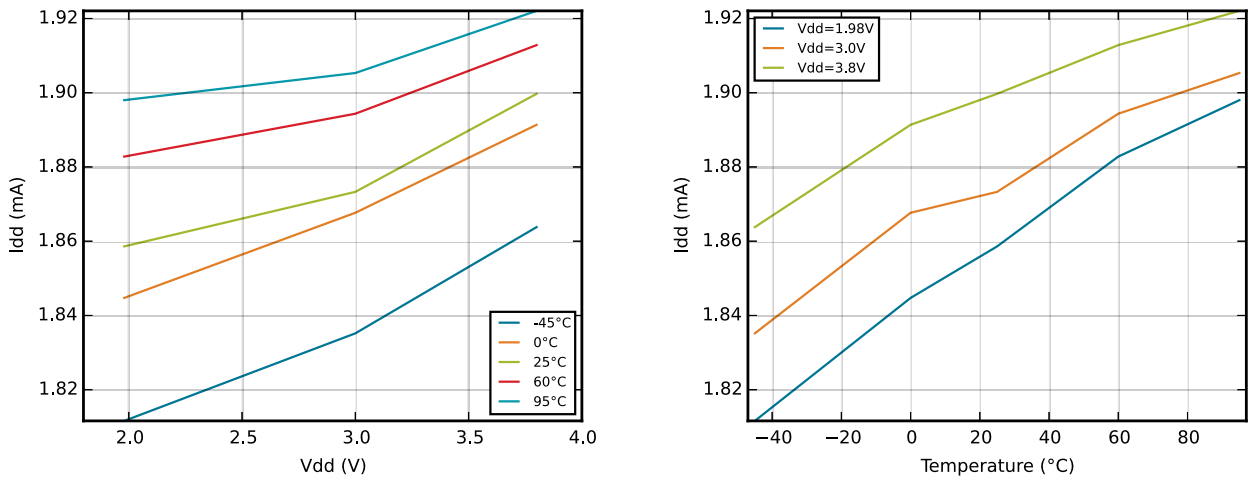

Figure 3.4. EM0 Current consumption while executing prime number calculation code from flash with HFRCO running at 11 MHz

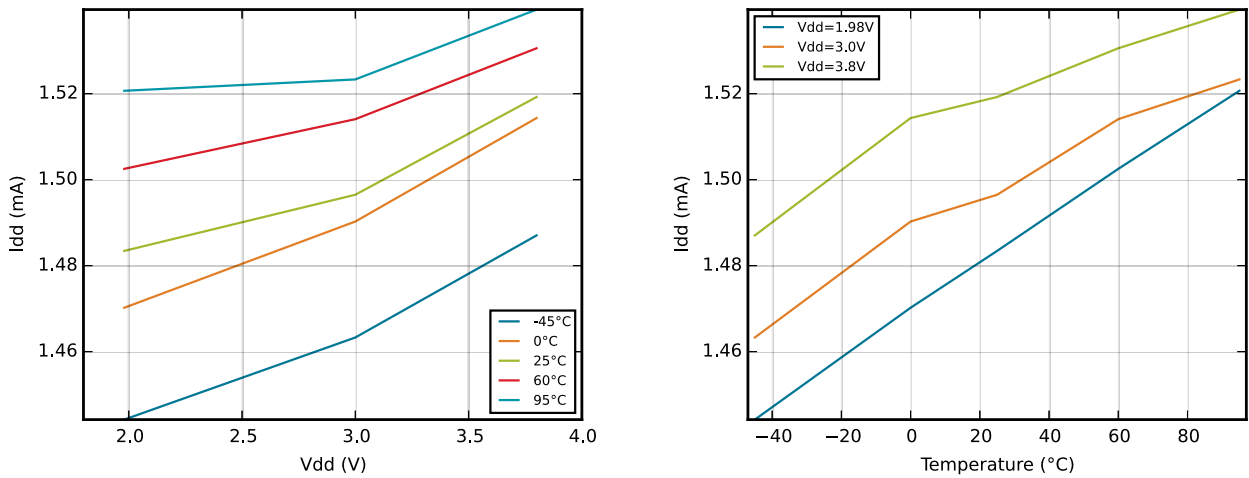
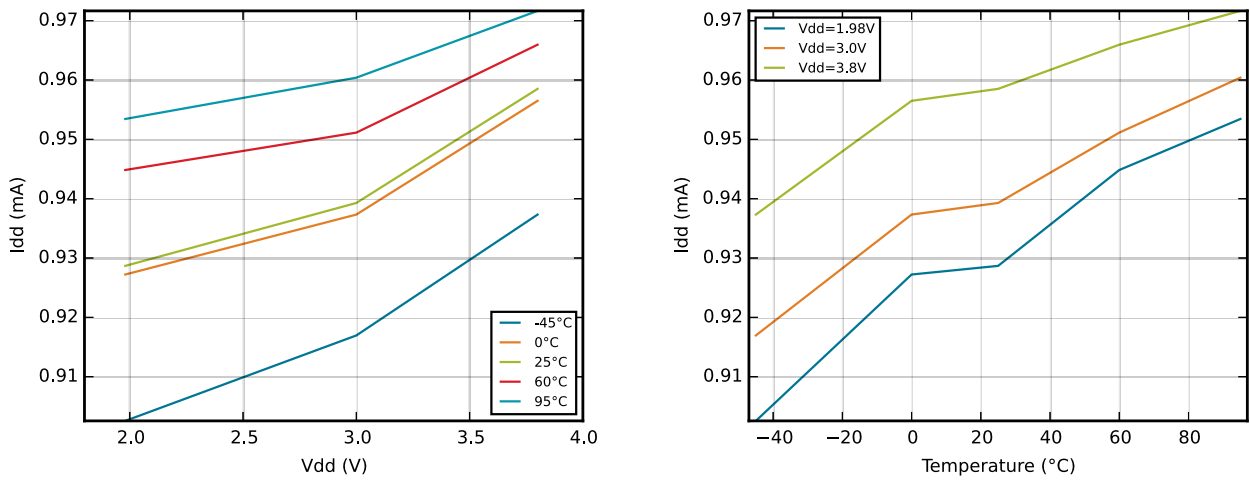

Figure 3.5. EM0 Current consumption while executing prime number calculation code from flash with HFRCO running at 6.6 MHz



3.4.2 EM1 Current Consumption

Figure 3.6. EM1 Current consumption with all peripheral clocks disabled and HFRCO running at 24 MHz

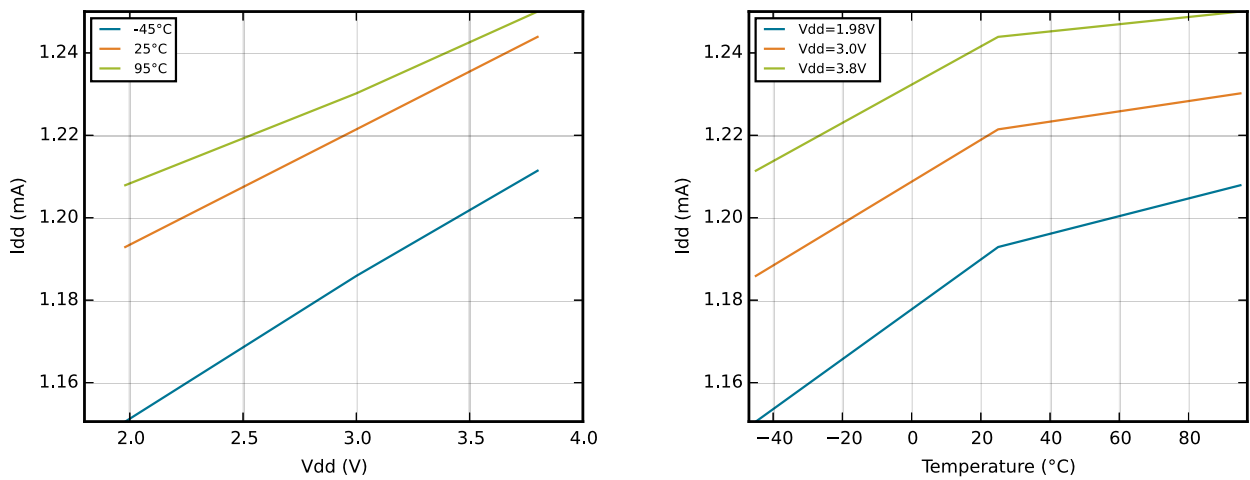

Figure 3.7. EM1 Current consumption with all peripheral clocks disabled and HFRCO running at 21 MHz

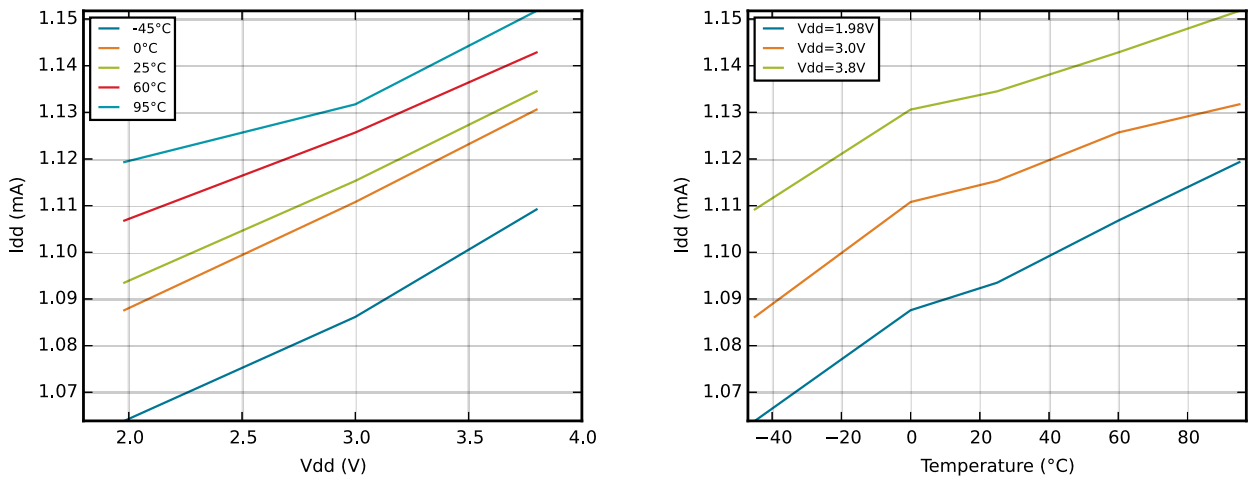

Figure 3.8. EM1 Current consumption with all peripheral clocks disabled and HFRCO running at 14 MHz

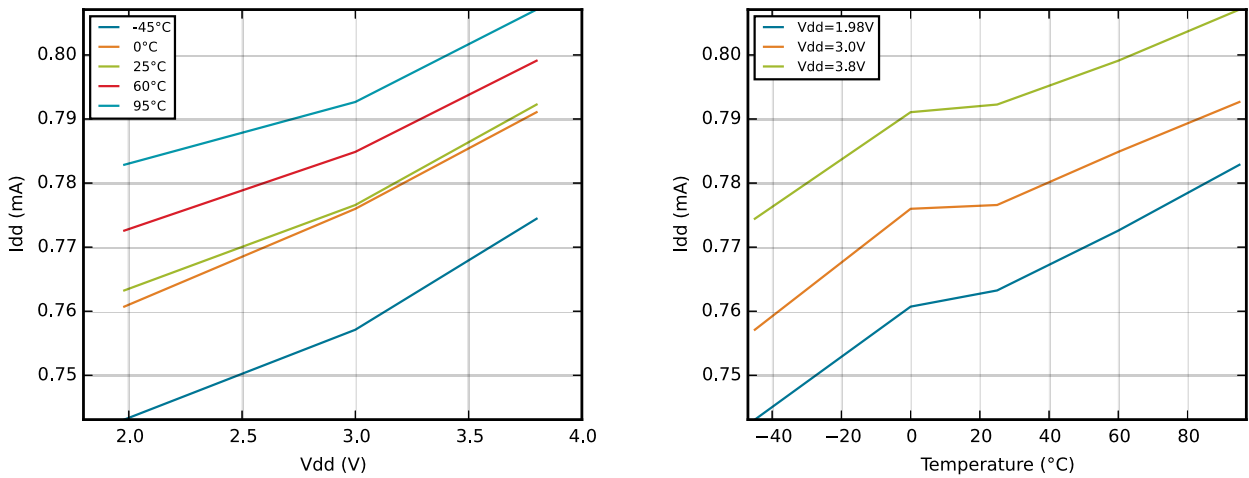

Figure 3.9. EM1 Current consumption with all peripheral clocks disabled and HFRCO running at 11 MHz

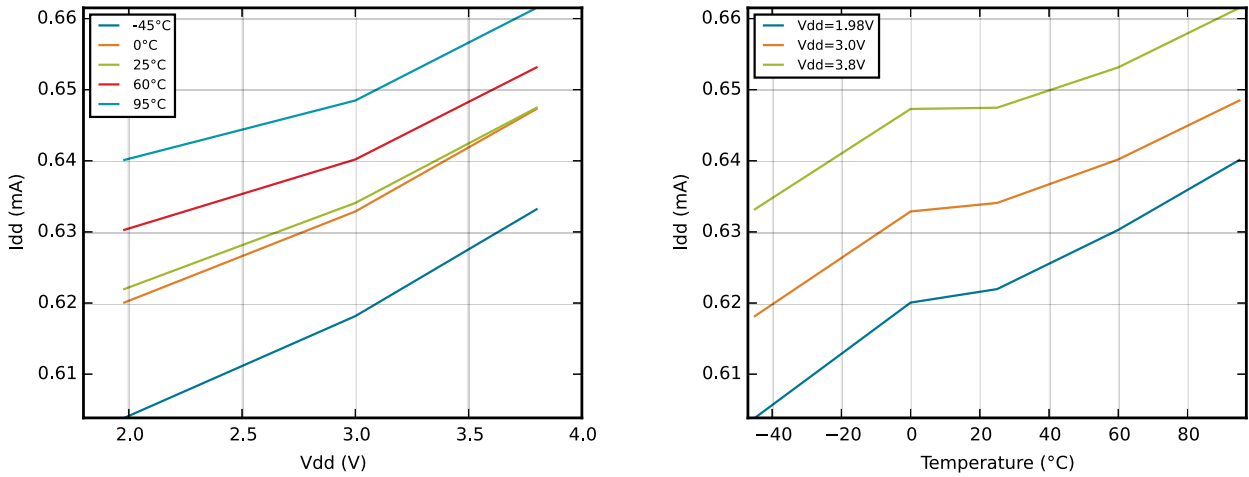
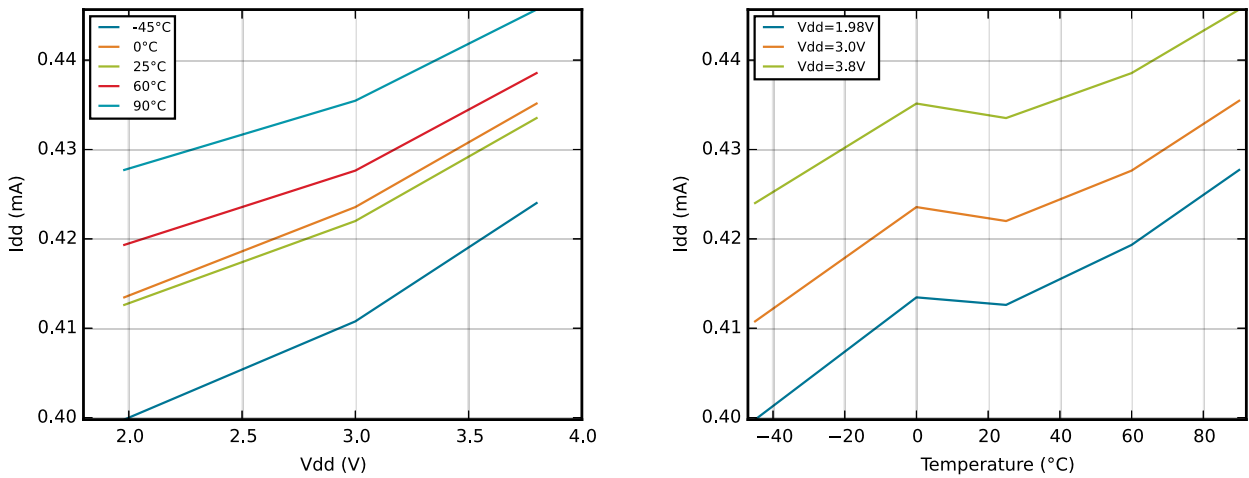
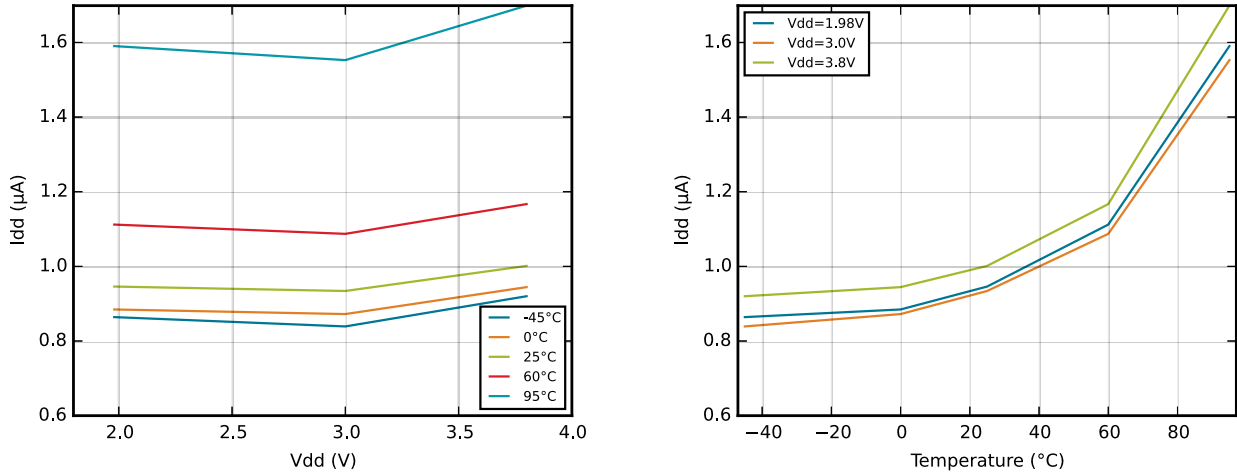

Figure 3.10. EM1 Current consumption with all peripheral clocks disabled and HFRCO running at 6.6 MHz



3.4.3 EM2 Current Consumption

Figure 3.11. EM2 current consumption. RTC prescaled to 1kHz, 32.768 kHz LFRCO.



3.4.4 EM3 Current Consumption

Figure 3.12. EM3 current consumption.

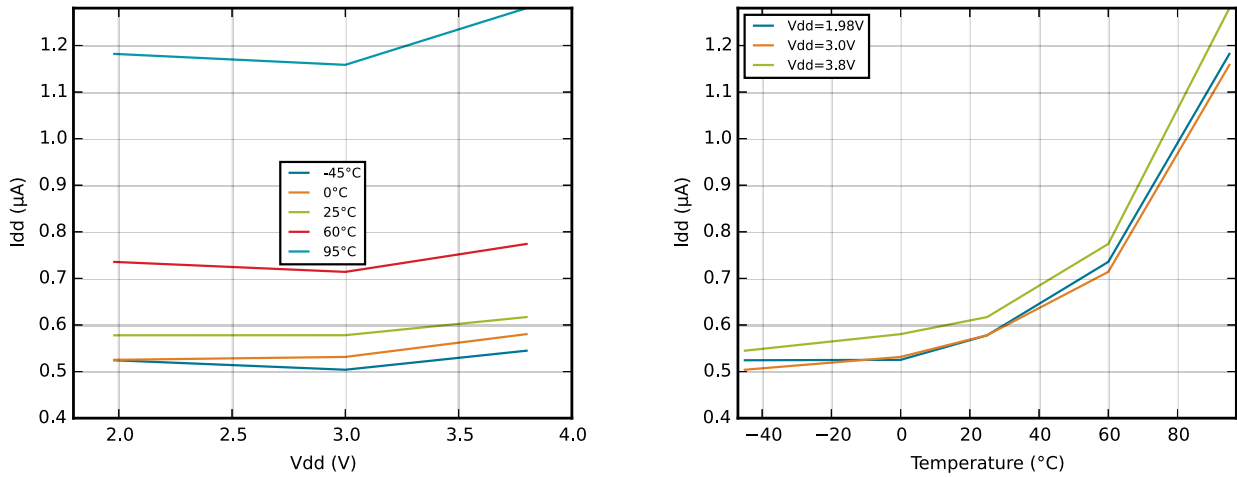

3.4.5 EM4 Current Consumption

Figure 3.13. EM4 current consumption.

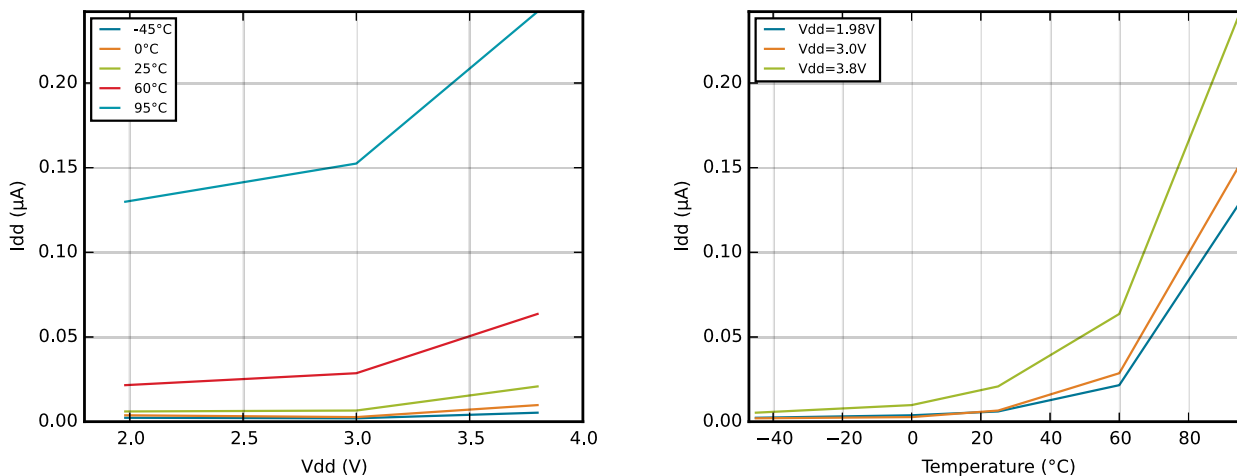

3.5 Transition between Energy Modes

The transition times are measured from the trigger to the first clock edge in the CPU.

Table 3.4. Energy Modes Transitions

Symbol	Parameter	Min	Typ	Max	Unit
t_{EM10}	Transition time from EM1 to EM0		0		HF-CORE-CLK cycles
t_{EM20}	Transition time from EM2 to EM0		2		μs
t_{EM30}	Transition time from EM3 to EM0		2		μs
t_{EM40}	Transition time from EM4 to EM0		163		μs

3.6 Power Management

The EFM32HG requires the AVDD_x, VDD_DREG and IOVDD_x pins to be connected together (with optional filter) at the PCB level. For practical schematic recommendations, please see the application note, "AN0002 EFM32 Hardware Design Considerations".

Table 3.5. Power Management

Symbol	Parameter	Condition	Min	Typ	Max	Unit
V _{BODextthr-}	BOD threshold on falling external supply voltage	EM0	1.74		1.96	V
		EM2	1.71	1.86	1.98	V
V _{BODextthr+}	BOD threshold on rising external supply voltage			1.85		V
t _{RESET}	Delay from reset is released until program execution starts	Applies to Power-on Reset, Brown-out Reset and pin reset.		163		μs
C _{DECOUPLE}	Voltage regulator decoupling capacitor.	X5R capacitor recommended. Apply between DECOUPLE pin and GROUND		1		μF
C _{USB_VREGO}	USB voltage regulator out decoupling capacitor.	X5R capacitor recommended. Apply between USB_VREGO pin and GROUND		1		μF
C _{USB_VREGI}	USB voltage regulator in decoupling capacitor.	X5R capacitor recommended. Apply between USB_VREGI pin and GROUND		4.7		μF

3.7 Flash

Table 3.6. Flash

Symbol	Parameter	Condition	Min	Typ	Max	Unit
EC _{FLASH}	Flash erase cycles before failure		20000			cycles
RET _{FLASH}	Flash data retention	T _{AMB} <150°C	10000			h
		T _{AMB} <85°C	10			years
		T _{AMB} <70°C	20			years
t _{W_PROG}	Word (32-bit) programming time		20			μs
t _{P_ERASE}	Page erase time		20	20.4	20.8	ms
t _{D_ERASE}	Device erase time		40	40.8	41.6	ms
I _{ERASE}	Erase current				7 ¹	mA
I _{WRITE}	Write current				7 ¹	mA
V _{FLASH}	Supply voltage during flash erase and write		1.98		3.8	V

¹Measured at 25°C

3.8 General Purpose Input Output

Table 3.7. GPIO

Symbol	Parameter	Condition	Min	Typ	Max	Unit
V _{IOIL}	Input low voltage				0.30V _{DD}	V
V _{IOIH}	Input high voltage		0.70V _{DD}			V

Symbol	Parameter	Condition	Min	Typ	Max	Unit
V _{IOOH}	Output high voltage (Production test condition = 3.0V, DRIVEMODE = STANDARD)	Sourcing 0.1 mA, V _{DD} =1.98 V, GPIO_Px_CTRL DRIVEMODE = LOWEST		0.80V _{DD}		V
		Sourcing 0.1 mA, V _{DD} =3.0 V, GPIO_Px_CTRL DRIVEMODE = LOWEST		0.90V _{DD}		V
		Sourcing 1 mA, V _{DD} =1.98 V, GPIO_Px_CTRL DRIVEMODE = LOW		0.85V _{DD}		V
		Sourcing 1 mA, V _{DD} =3.0 V, GPIO_Px_CTRL DRIVEMODE = LOW		0.90V _{DD}		V
		Sourcing 6 mA, V _{DD} =1.98 V, GPIO_Px_CTRL DRIVEMODE = STANDARD	0.75V _{DD}			V
		Sourcing 6 mA, V _{DD} =3.0 V, GPIO_Px_CTRL DRIVEMODE = STANDARD	0.85V _{DD}			V
		Sourcing 20 mA, V _{DD} =1.98 V, GPIO_Px_CTRL DRIVEMODE = HIGH	0.60V _{DD}			V
		Sourcing 20 mA, V _{DD} =3.0 V, GPIO_Px_CTRL DRIVEMODE = HIGH	0.80V _{DD}			V
V _{IOOL}	Output low voltage (Production test condition = 3.0V, DRIVEMODE = STANDARD)	Sinking 0.1 mA, V _{DD} =1.98 V, GPIO_Px_CTRL DRIVEMODE = LOWEST		0.20V _{DD}		V
		Sinking 0.1 mA, V _{DD} =3.0 V, GPIO_Px_CTRL DRIVEMODE = LOWEST		0.10V _{DD}		V
		Sinking 1 mA, V _{DD} =1.98 V, GPIO_Px_CTRL DRIVEMODE = LOW		0.10V _{DD}		V
		Sinking 1 mA, V _{DD} =3.0 V, GPIO_Px_CTRL DRIVEMODE = LOW		0.05V _{DD}		V
		Sinking 6 mA, V _{DD} =1.98 V, GPIO_Px_CTRL DRIVEMODE = STANDARD			0.30V _{DD}	V
		Sinking 6 mA, V _{DD} =3.0 V, GPIO_Px_CTRL DRIVEMODE = STANDARD			0.20V _{DD}	V
		Sinking 20 mA, V _{DD} =1.98 V, GPIO_Px_CTRL DRIVEMODE = HIGH			0.35V _{DD}	V
		Sinking 20 mA, V _{DD} =3.0 V, GPIO_Px_CTRL DRIVEMODE = HIGH			0.25V _{DD}	V
I _{IOLEAK}	Input leakage current	High Impedance IO connected to GROUND or V _{DD}		±0.1	±40	nA
R _{PU}	I/O pin pull-up resistor			40		kOhm

Symbol	Parameter	Condition	Min	Typ	Max	Unit
R _{PD}	I/O pin pull-down resistor			40		kOhm
R _{IOESD}	Internal ESD series resistor			200		Ohm
t _{IOGLITCH}	Pulse width of pulses to be removed by the glitch suppression filter		10		50	ns
t _{IOOF}	Output fall time	GPIO_Px_CTRL DRIVEMODE = LOWEST and load capacitance C _L =12.5-25pF.	20+0.1C _L		250	ns
		GPIO_Px_CTRL DRIVEMODE = LOW and load capacitance C _L =350-600pF	20+0.1C _L		250	ns
V _{IOHYST}	I/O pin hysteresis (V _{IOTHR+} - V _{IOTHR-})	V _{DD} = 1.98 - 3.8 V	0.1V _{DD}			V

Figure 3.14. Typical Low-Level Output Current, 2V Supply Voltage

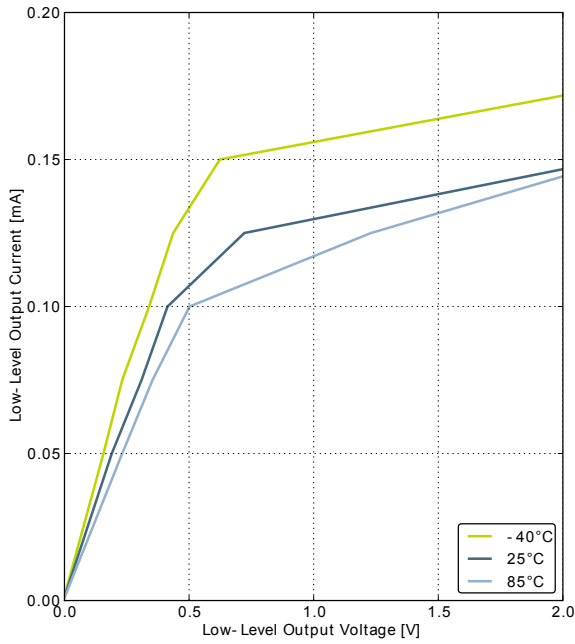

GPIO_Px_CTRL DRIVEMODE = LOWEST

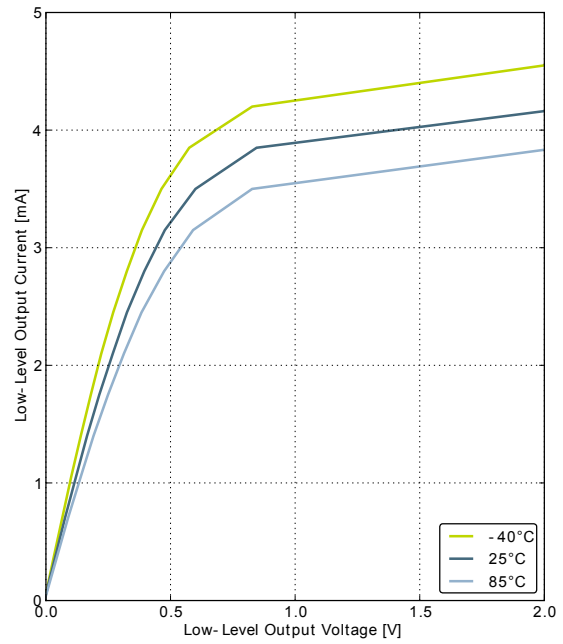

GPIO_Px_CTRL DRIVEMODE = LOW

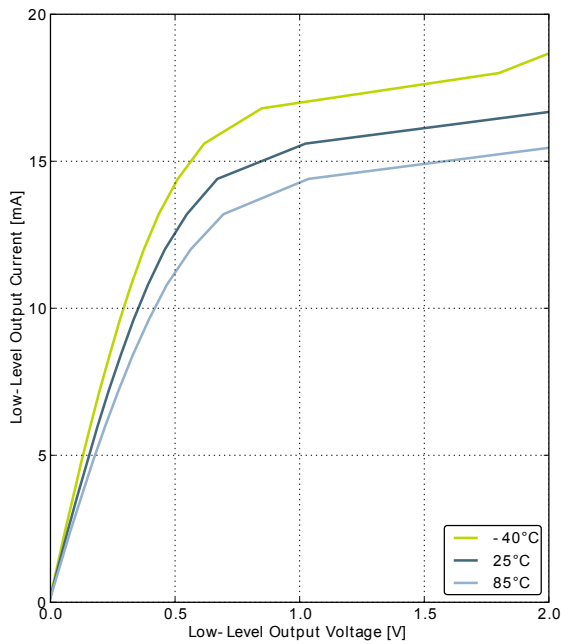

GPIO_Px_CTRL DRIVEMODE = STANDARD

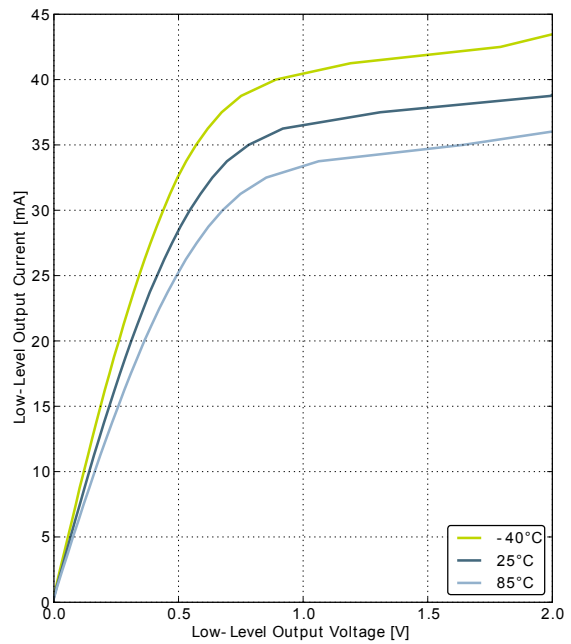

GPIO_Px_CTRL DRIVEMODE = HIGH

Figure 3.15. Typical High-Level Output Current, 2V Supply Voltage

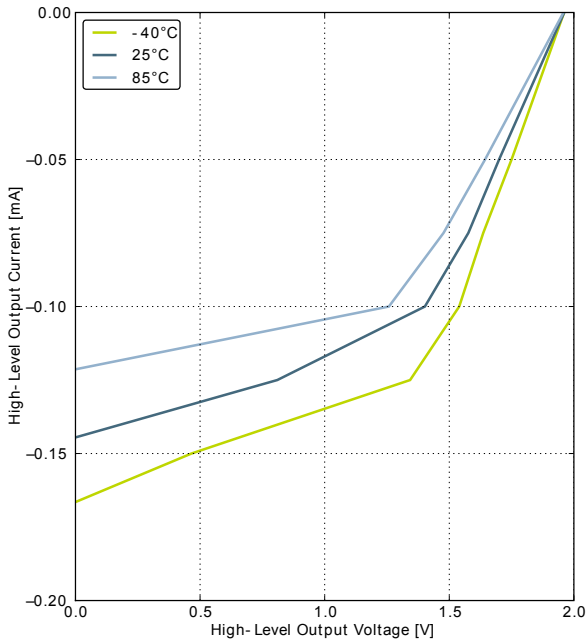

GPIO_Px_CTRL DRIVEMODE = LOWEST

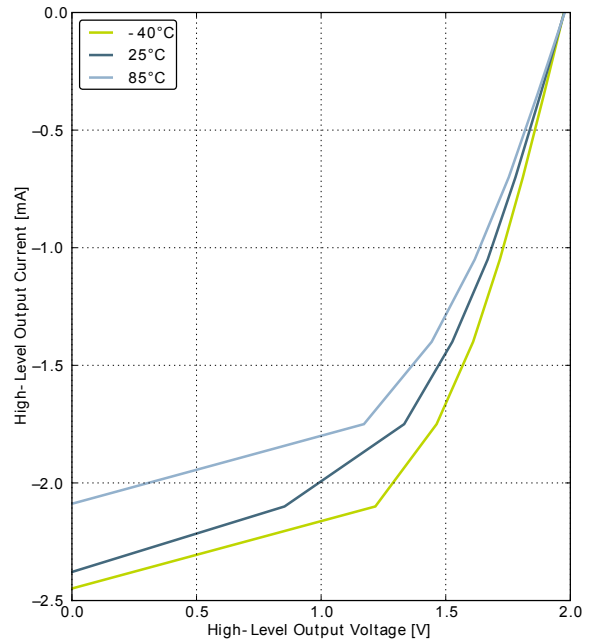

GPIO_Px_CTRL DRIVEMODE = LOW

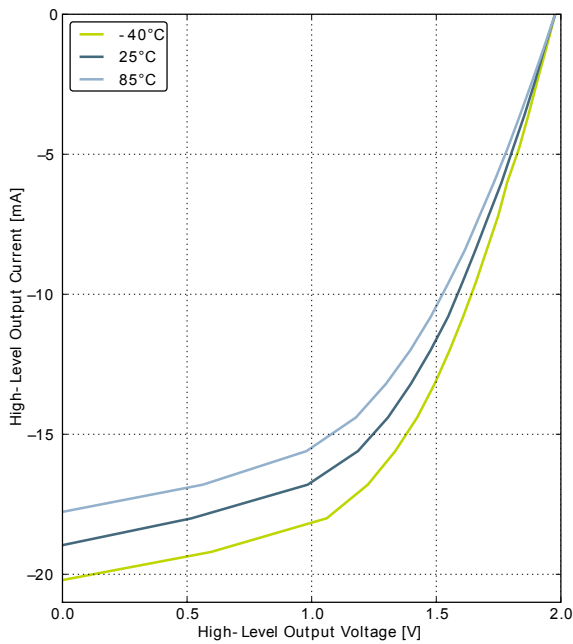

GPIO_Px_CTRL DRIVEMODE = STANDARD

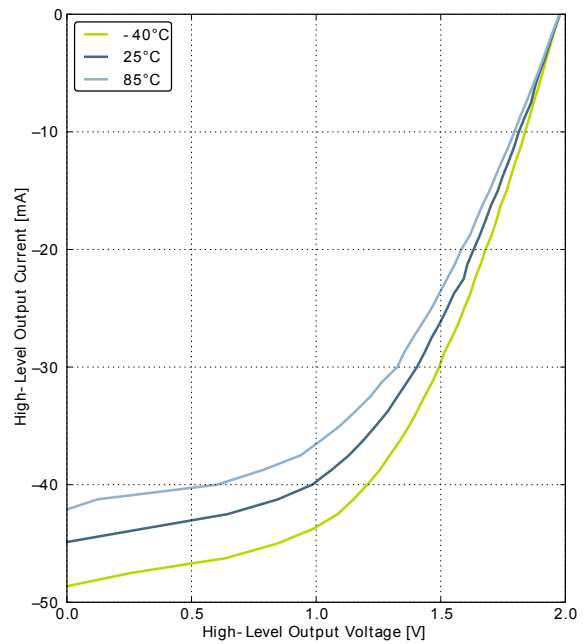

GPIO_Px_CTRL DRIVEMODE = HIGH

Figure 3.16. Typical Low-Level Output Current, 3V Supply Voltage

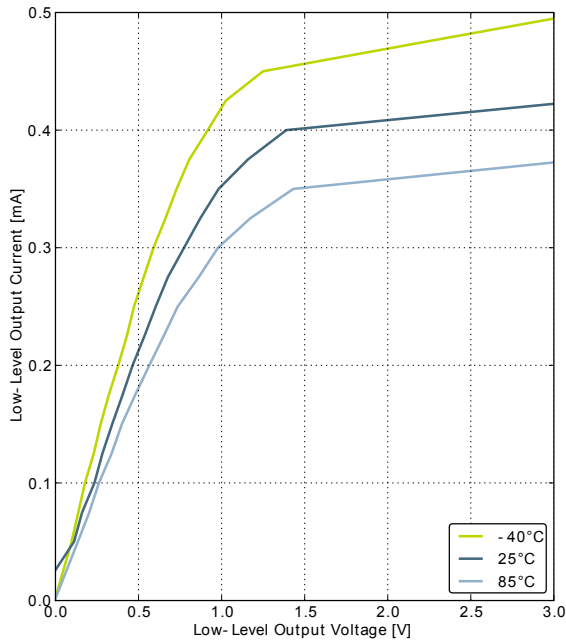

GPIO_Px_CTRL DRIVEMODE = LOWEST

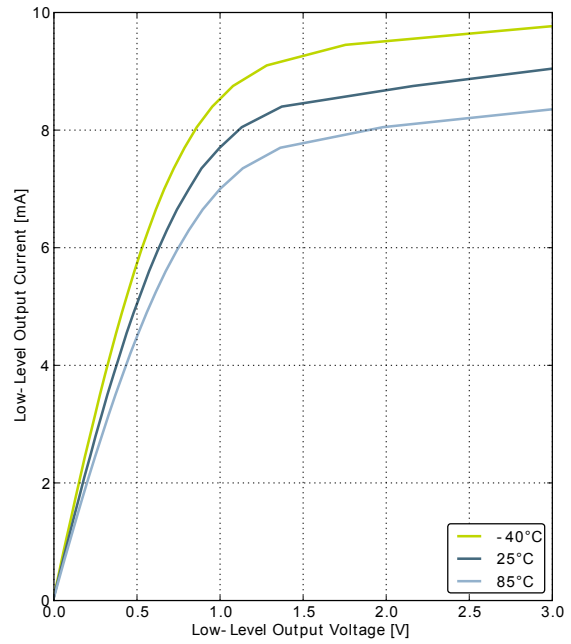

GPIO_Px_CTRL DRIVEMODE = LOW

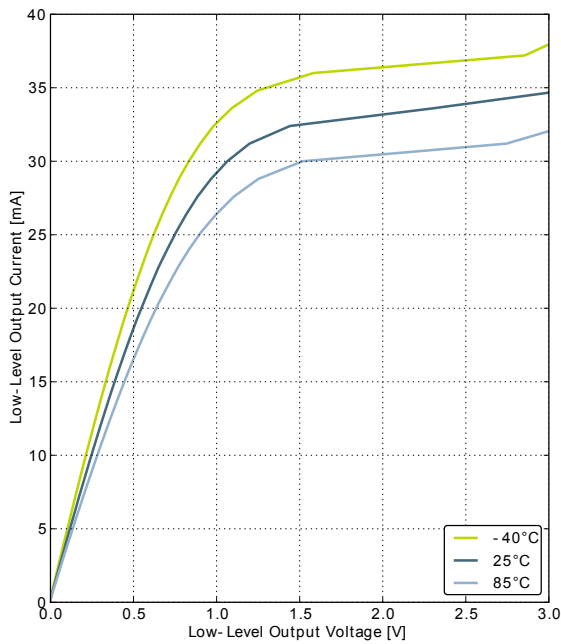

GPIO_Px_CTRL DRIVEMODE = STANDARD

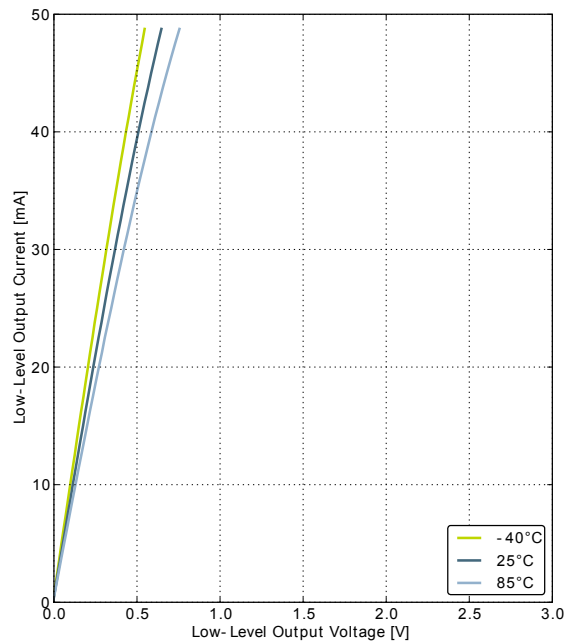

GPIO_Px_CTRL DRIVEMODE = HIGH

Figure 3.17. Typical High-Level Output Current, 3V Supply Voltage

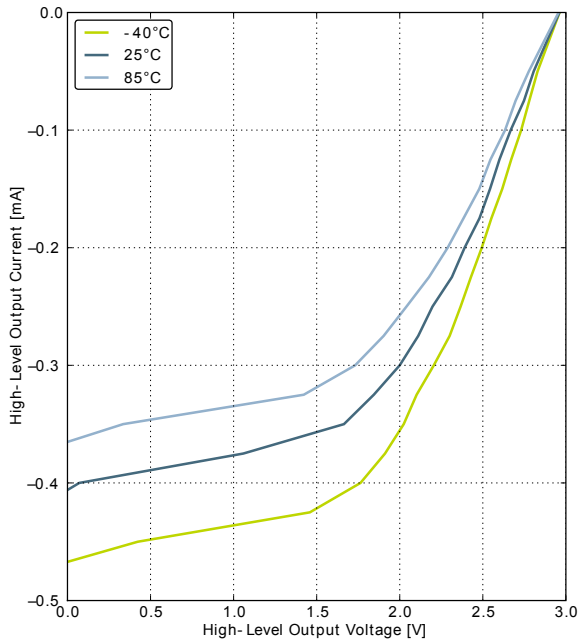

GPIO_Px_CTRL DRIVEMODE = LOWEST

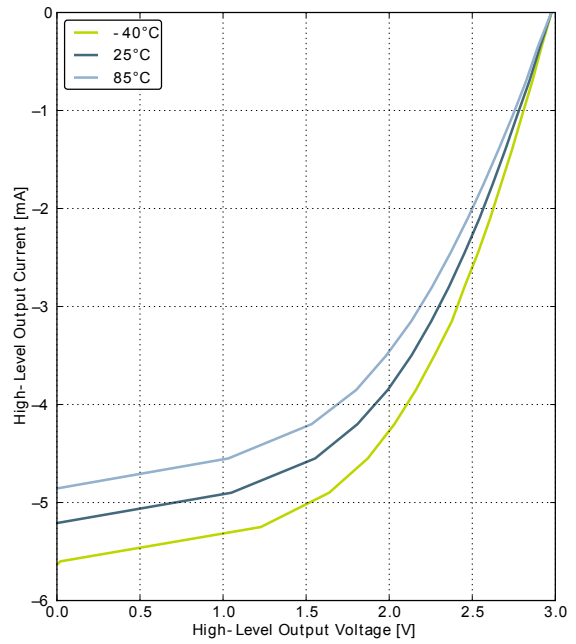

GPIO_Px_CTRL DRIVEMODE = LOW

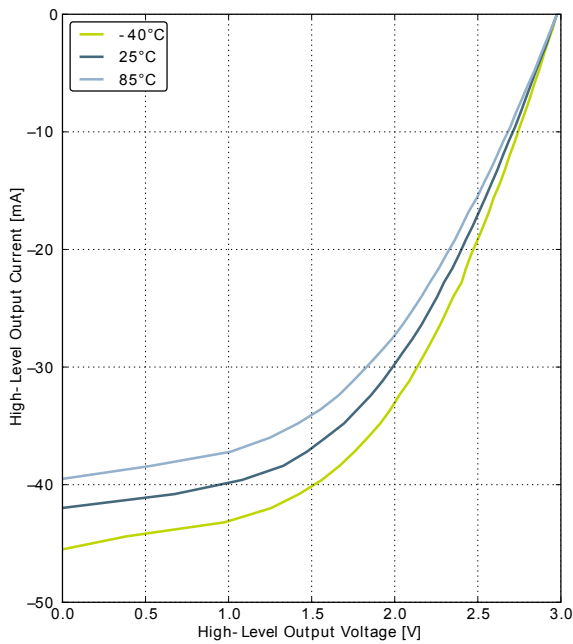

GPIO_Px_CTRL DRIVEMODE = STANDARD

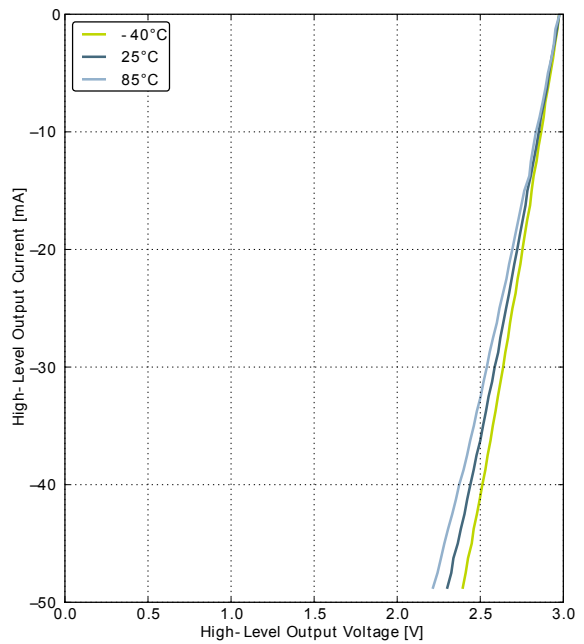

GPIO_Px_CTRL DRIVEMODE = HIGH

Figure 3.18. Typical Low-Level Output Current, 3.8V Supply Voltage

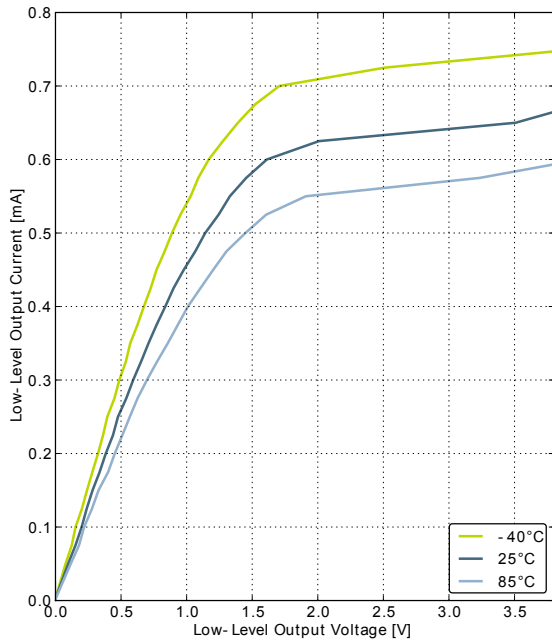

GPIO_Px_CTRL DRIVEMODE = LOWEST

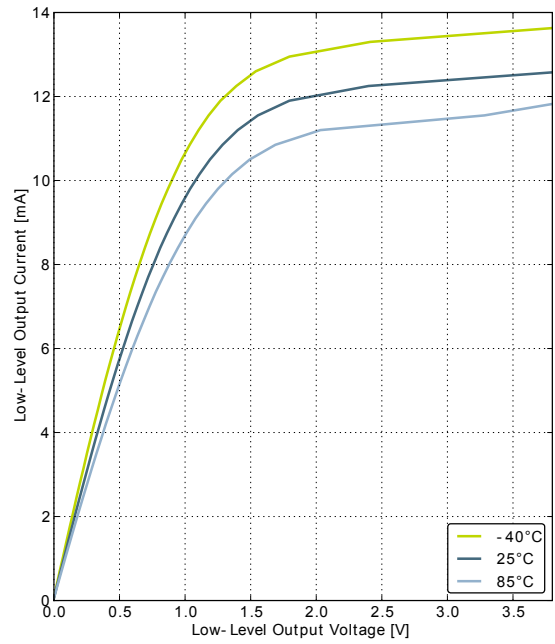

GPIO_Px_CTRL DRIVEMODE = LOW

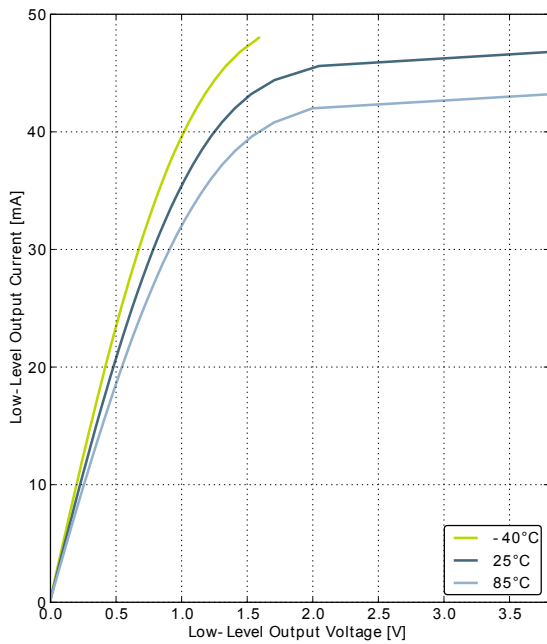

GPIO_Px_CTRL DRIVEMODE = STANDARD

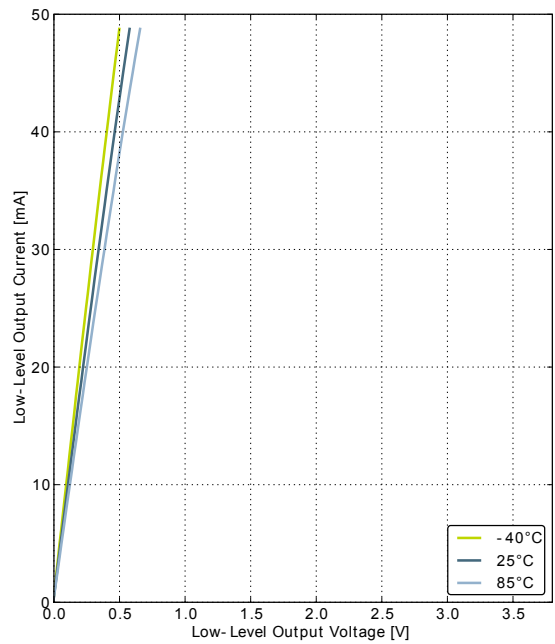

GPIO_Px_CTRL DRIVEMODE = HIGH

Figure 3.19. Typical High-Level Output Current, 3.8V Supply Voltage

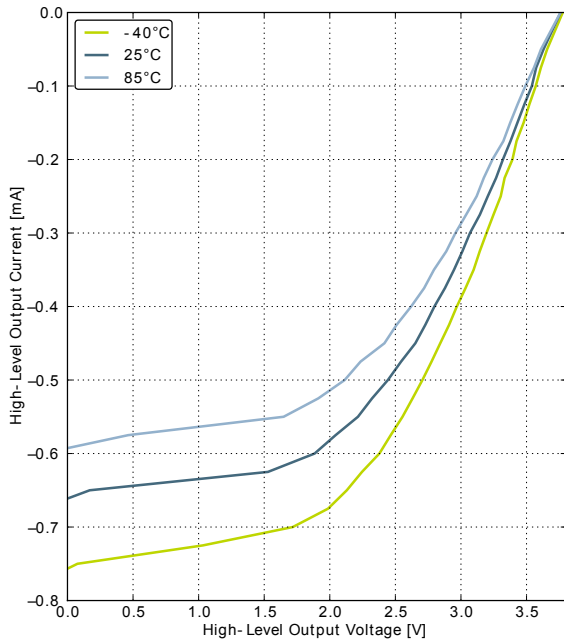

GPIO_Px_CTRL DRIVEMODE = LOWEST

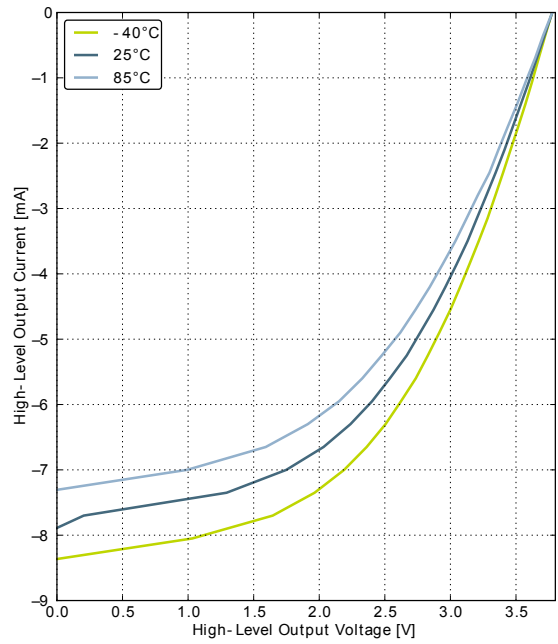

GPIO_Px_CTRL DRIVEMODE = LOW

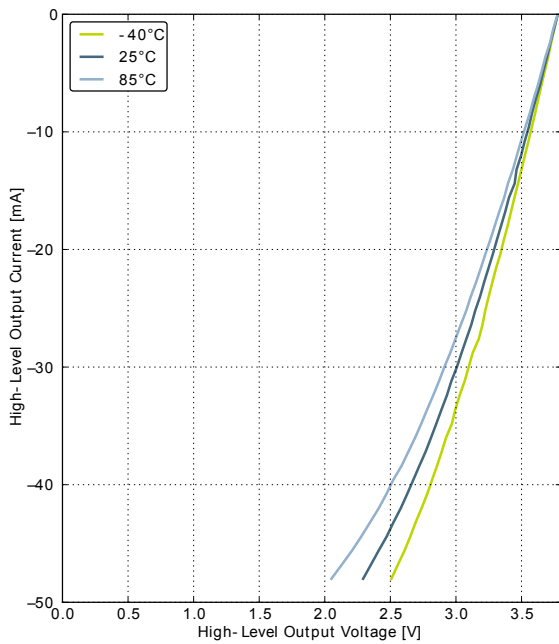

GPIO_Px_CTRL DRIVEMODE = STANDARD

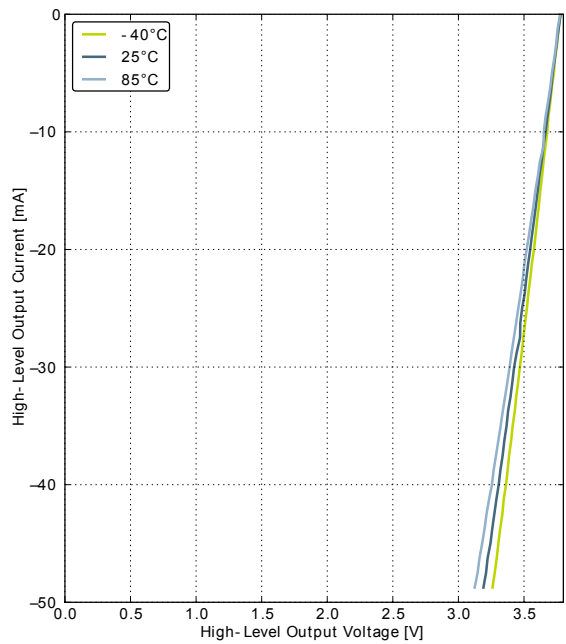

GPIO_Px_CTRL DRIVEMODE = HIGH

3.9 Oscillators

3.9.1 LFXO

Table 3.8. LFXO

Symbol	Parameter	Condition	Min	Typ	Max	Unit
f_{LFXO}	Supported nominal crystal frequency			32.768		kHz
ESR_{LFXO}	Supported crystal equivalent series resistance (ESR)			30	120	kOhm
C_{LFXOL}	Supported crystal external load range		5		25	pF
I_{LFXO}	Current consumption for core and buffer after startup.	ESR=30 kOhm, $C_L=10$ pF, LFXOBOOST in CMU_CTRL is 1		190		nA
t_{LFXO}	Start-up time.	ESR=30 kOhm, $C_L=10$ pF, 40% - 60% duty cycle has been reached, LFXOBOOST in CMU_CTRL is 1		1100		ms

For safe startup of a given crystal, the Configurator tool in Simplicity Studio contains a tool to help users configure both load capacitance and software settings for using the LFXO. For details regarding the crystal configuration, the reader is referred to application note "AN0016 EFM32 Oscillator Design Consideration".

3.9.2 HFXO

Table 3.9. HFXO

Symbol	Parameter	Condition	Min	Typ	Max	Unit
f_{HFXO}	Supported frequency, any mode		4		25	MHz
ESR_{HFXO}	Supported crystal equivalent series resistance (ESR)	Crystal frequency 25 MHz		30	100	Ohm
		Crystal frequency 4 MHz		400	1500	Ohm
g_{mHFXO}	The transconductance of the HFXO input transistor at crystal startup	HFXOBOOST in CMU_CTRL equals 0b11	20			mS
C_{HFXOL}	Supported crystal external load range		5		25	pF
I_{HFXO}	Current consumption for HFXO after startup	4 MHz: ESR=400 Ohm, $C_L=20$ pF, HFXOBOOST in CMU_CTRL equals 0b11		85		μ A
		25 MHz: ESR=30 Ohm, $C_L=10$ pF, HFXOBOOST in CMU_CTRL equals 0b11		165		μ A
t_{HFXO}	Startup time	25 MHz: ESR=30 Ohm, $C_L=10$ pF, HFXOBOOST in CMU_CTRL equals 0b11		785		μ s

3.9.3 LFRCO

Table 3.10. LFRCO

Symbol	Parameter	Condition	Min	Typ	Max	Unit
f_{LFRCO}	Oscillation frequency, $V_{DD}=3.0\text{ V}$, $T_{AMB}=25^{\circ}\text{C}$		31.3	32.768	34.3	kHz
t_{LFRCO}	Startup time not including software calibration			150		μs
I_{LFRCO}	Current consumption			361	492	nA
TUNESTEP _{LFRCO}	Frequency step for LSB change in TUNING value			202		Hz

Figure 3.20. Calibrated LFRCO Frequency vs Temperature and Supply Voltage

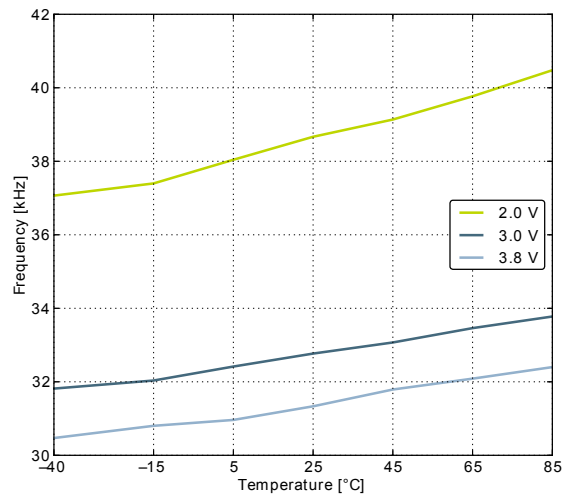
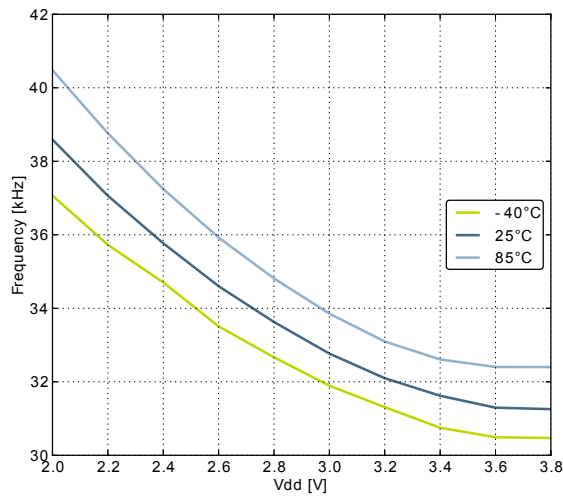

3.9.4 HFRCO

Table 3.11. HFRCO

Symbol	Parameter	Condition	Min	Typ	Max	Unit
f_{HFRCO}	Oscillation frequency, $V_{\text{DD}}=3.0\text{ V}$, $T_{\text{AMB}}=25^{\circ}\text{C}$	24 MHz frequency band	23.28	24.0	24.72	MHz
		21 MHz frequency band	20.37	21.0	21.63	MHz
		14 MHz frequency band	13.58	14.0	14.42	MHz
		11 MHz frequency band	10.67	11.0	11.33	MHz
		7 MHz frequency band	6.40	6.60	6.80	MHz
		1 MHz frequency band	1.15	1.20	1.25	MHz
$t_{\text{HFRCO_settling}}$	Settling time after start-up	$f_{\text{HFRCO}} = 14\text{ MHz}$		0.6		Cycles
I_{HFRCO}	Current consumption	$f_{\text{HFRCO}} = 24\text{ MHz}$		158	184	μA
		$f_{\text{HFRCO}} = 21\text{ MHz}$		143	175	μA
		$f_{\text{HFRCO}} = 14\text{ MHz}$		113	140	μA
		$f_{\text{HFRCO}} = 11\text{ MHz}$		101	125	μA
		$f_{\text{HFRCO}} = 6.6\text{ MHz}$		84	105	μA
		$f_{\text{HFRCO}} = 1.2\text{ MHz}$		27	40	μA
TUNESTEP _{H-FR} CO	Frequency step for LSB change in TUNING value	24 MHz frequency band		66.8 ¹		kHz
		21 MHz frequency band		52.8 ¹		kHz
		14 MHz frequency band		36.9 ¹		kHz
		11 MHz frequency band		30.1 ¹		kHz
		7 MHz frequency band		18.0 ¹		kHz
		1 MHz frequency band		3.4		kHz

¹The TUNING field in the CMU_HFRCOCTRL register may be used to adjust the HFRCO frequency. There is enough adjustment range to ensure that the frequency bands above 7 MHz will always have some overlap across supply voltage and temperature. By using a stable frequency reference such as the LFXO or HFXO, a firmware calibration routine can vary the TUNING bits and the frequency band to maintain the HFRCO frequency at any arbitrary value between 7 MHz and 21 MHz across operating conditions.

Figure 3.21. Calibrated HFRCO 1 MHz Band Frequency vs Supply Voltage and Temperature

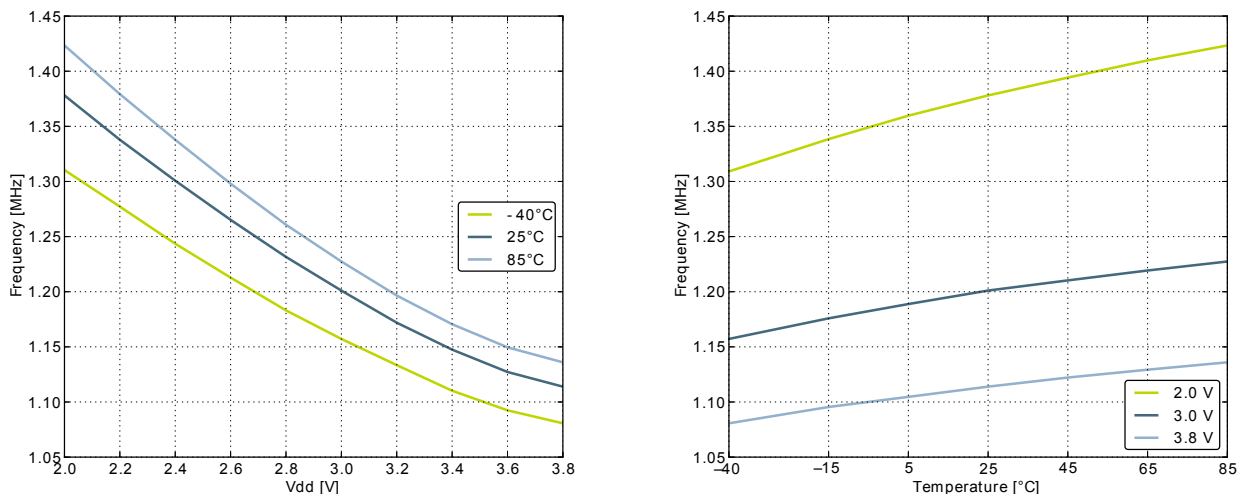

Figure 3.22. Calibrated HFRCO 7 MHz Band Frequency vs Supply Voltage and Temperature

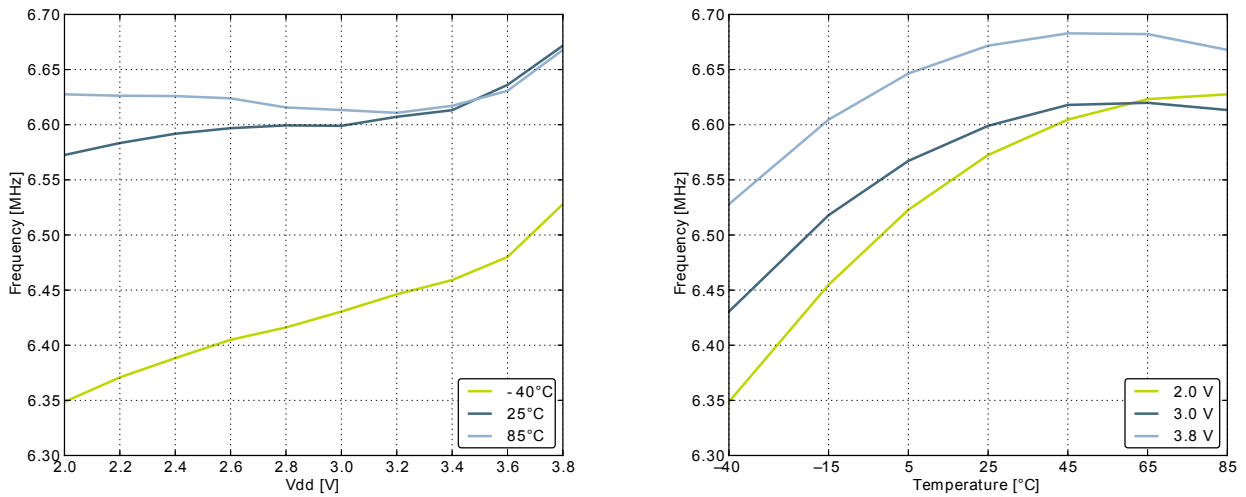

Figure 3.23. Calibrated HFRCO 11 MHz Band Frequency vs Supply Voltage and Temperature

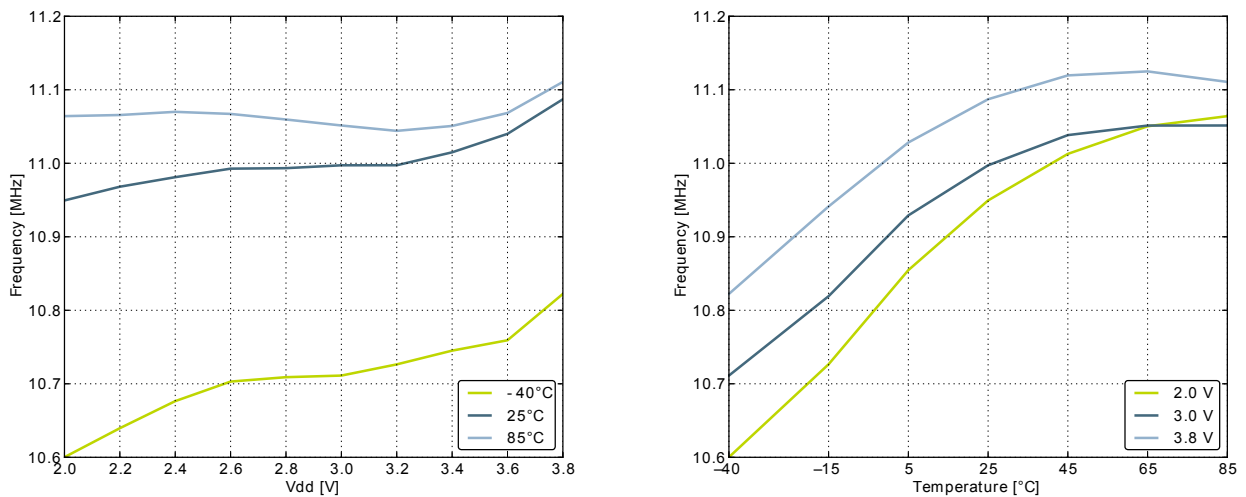

Figure 3.24. Calibrated HFRCO 14 MHz Band Frequency vs Supply Voltage and Temperature

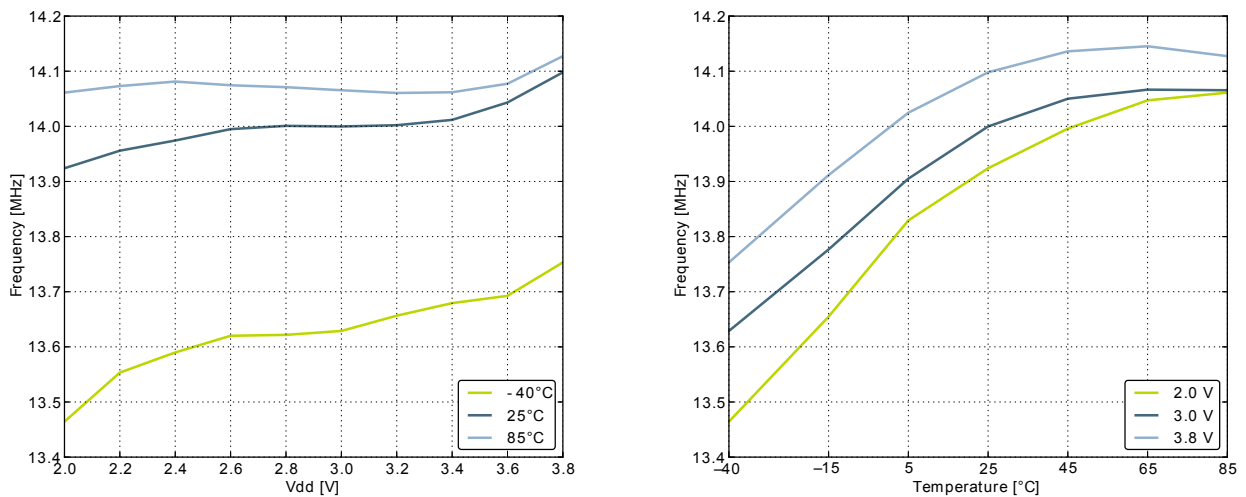
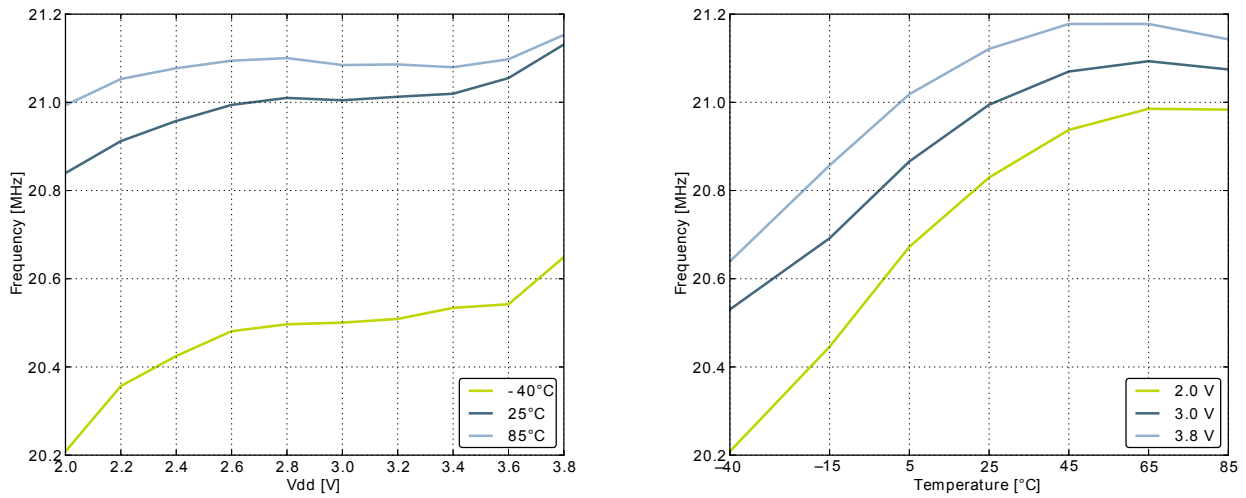

Figure 3.25. Calibrated HFRCO 21 MHz Band Frequency vs Supply Voltage and Temperature



3.9.5 AUXHFRCO

Table 3.12. AUXHFRCO

Symbol	Parameter	Condition	Min	Typ	Max	Unit
$f_{AUXHFRCO}$	Oscillation frequency, $V_{DD}=3.0\text{ V}$, $T_{AMB}=25^{\circ}\text{C}$	21 MHz frequency band	20.37	21.0	21.63	MHz
		14 MHz frequency band	13.58	14.0	14.42	MHz
		11 MHz frequency band	10.67	11.0	11.33	MHz
		7 MHz frequency band	6.40	6.60	6.80	MHz
		1 MHz frequency band	1.15	1.20	1.25	MHz
$t_{AUXHFRCO_settling}$	Settling time after start-up	$f_{AUXHFRCO} = 14\text{ MHz}$		0.6		Cycles
$TUNESTEP_{AUXHFRCO}$	Frequency step for LSB change in TUNING value	21 MHz frequency band		52.8		kHz
		14 MHz frequency band		36.9		kHz
		11 MHz frequency band		30.1		kHz
		7 MHz frequency band		18.0		kHz
		1 MHz frequency band		3.4		kHz

3.9.6 USHFRCO

Table 3.13. USHFRCO

Symbol	Parameter	Condition	Min	Typ	Max	Unit
f _{USHFRCO}	Oscillation frequency	No Clock Recovery, Full Temperature and Supply Range, 48 MHz band	47.10	48.00	48.90	MHz
		No Clock Recovery, Full Temperature and Supply Range, 24 MHz band	23.73	24.00	24.32	MHz
		No Clock Recovery, 25°C, 3.3V, 48 MHz band	47.50	48.00	48.50	MHz
		No Clock Recovery, 25°C, 3.3V, 24 MHz band	23.86	24.00	24.16	MHz
		USB Active with Clock Recovery, Full Temperature and Supply Range	47.88	48.00	48.12	MHz
TC _{USHFRCO}	Temperature coefficient	3.3V		0.0175		%/°C
VC _{USHFRCO}	Supply voltage coefficient	25°C		0.0045		%/V
I _{USHFRCO}	Current consumption	f _{USHFRCO} = 48 MHz	1.21	1.36	1.48	mA
		f _{USHFRCO} = 24 MHz	0.81	0.92	1.02	mA

3.9.7 ULFRCO

Table 3.14. ULFRCO

Symbol	Parameter	Condition	Min	Typ	Max	Unit
f _{ULFRCO}	Oscillation frequency	25°C, 3V	0.70		1.75	kHz
TC _{ULFRCO}	Temperature coefficient			0.05		%/°C
VC _{ULFRCO}	Supply voltage coefficient			-18.2		%/V

3.10 Analog Comparator (ACMP)

Table 3.15. ACMP

Symbol	Parameter	Condition	Min	Typ	Max	Unit
V _{ACMPIN}	Input voltage range		0		V _{DD}	V
V _{ACMPCM}	ACMP Common Mode voltage range		0		V _{DD}	V
I _{ACMP}	Active current	BIASPROG=0b0000, FULL-BIAS=0 and HALFBIAS=1 in ACMPn_CTRL register		0.1	0.4	μA
		BIASPROG=0b1111, FULL-BIAS=0 and HALFBIAS=0 in ACMPn_CTRL register		2.87	15	μA
		BIASPROG=0b1111, FULL-BIAS=1 and HALFBIAS=0 in ACMPn_CTRL register		195	520	μA
I _{ACMPREF}	Current consumption of internal voltage reference	Internal voltage reference off. Using external voltage reference		0		μA
		Internal voltage reference		5		μA
V _{ACMPOFFSET}	Offset voltage	BIASPROG= 0b1010, FULL-BIAS=0 and HALFBIAS=0 in ACMPn_CTRL register	-12	0	12	mV
V _{ACMPHYST}	ACMP hysteresis	Programmable		17		mV
R _{CSRES}	Capacitive Sense Internal Resistance	CSRESSEL=0b00 in ACMPn_INPUTSEL		40		kOhm
		CSRESSEL=0b01 in ACMPn_INPUTSEL		70		kOhm
		CSRESSEL=0b10 in ACMPn_INPUTSEL		101		kOhm
		CSRESSEL=0b11 in ACMPn_INPUTSEL		132		kOhm
t _{ACMPSTART}	Startup time				10	μs

The total ACMP current is the sum of the contributions from the ACMP and its internal voltage reference as given in Equation 3.1 (p. 33) . I_{ACMPREF} is zero if an external voltage reference is used.

Total ACMP Active Current

$$I_{ACMPTOTAL} = I_{ACMP} + I_{ACMPREF} \tag{3.1}$$

Figure 3.26. ACMP Characteristics, Vdd = 3V, Temp = 25°C, FULLBIAS = 0, HALFBIAS = 1

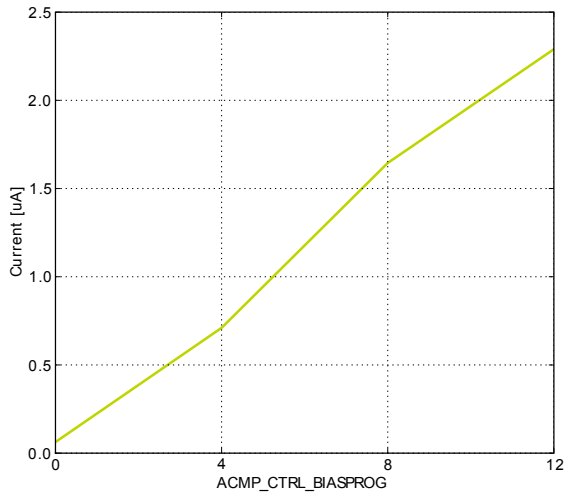

Current consumption, HYSTSEL = 4

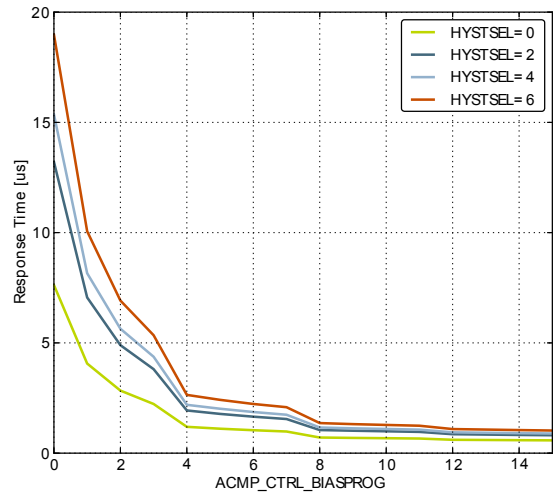

Response time, $V_{cm} = 1.25V$, CP+ to CP- = 100mV

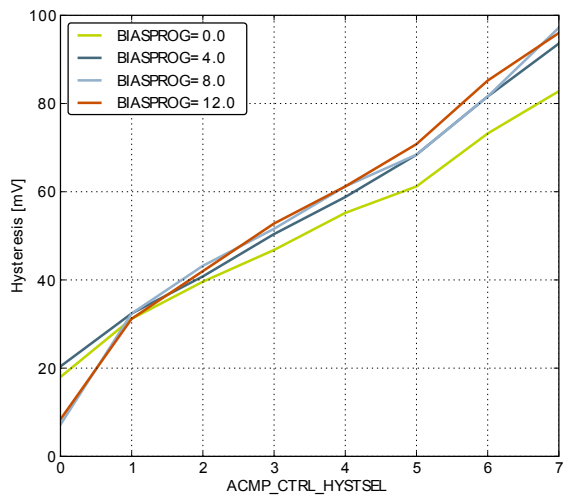

Hysteresis

3.11 Voltage Comparator (VCMP)

Table 3.16. VCMP

Symbol	Parameter	Condition	Min	Typ	Max	Unit
V _{VCMPIN}	Input voltage range			V _{DD}		V
V _{VCMP_{CM}}	VCMP Common Mode voltage range			V _{DD}		V
I _{VCMP}	Active current	BIASPROG=0b0000 and HALFBIAS=1 in VCMPn_CTRL register		0.2	0.8	μA
		BIASPROG=0b1111 and HALFBIAS=0 in VCMPn_CTRL register. LPREF=0.		22	35	μA
t _{VCMPREF}	Startup time reference generator	NORMAL		10		μs
V _{VCMP_{OFFSET}}	Offset voltage	Single ended		10		mV
		Differential		10		mV
V _{VCMPHYST}	VCMP hysteresis			17		mV
t _{VCMPSTART}	Startup time				10	μs

The V_{DD} trigger level can be configured by setting the TRIGLEVEL field of the VCMP_CTRL register in accordance with the following equation:

VCMP Trigger Level as a Function of Level Setting

$$V_{DD \text{ Trigger Level}} = 1.667V + 0.034 \times \text{TRIGLEVEL} \tag{3.2}$$

3.12 I2C

Table 3.17. I2C Standard-mode (Sm)

Symbol	Parameter	Min	Typ	Max	Unit
f _{SCL}	SCL clock frequency		0	100 ¹	kHz
t _{LOW}	SCL clock low time		4.7		μs
t _{HIGH}	SCL clock high time		4.0		μs
t _{SU,DAT}	SDA set-up time		250		ns
t _{HD,DAT}	SDA hold time		8	3450 ^{2,3}	ns
t _{SU,STA}	Repeated START condition set-up time		4.7		μs
t _{HD,STA}	(Repeated) START condition hold time		4.0		μs
t _{SU,STO}	STOP condition set-up time		4.0		μs
t _{BUF}	Bus free time between a STOP and START condition		4.7		μs

¹For the minimum HPPERCLK frequency required in Standard-mode, see the I2C chapter in the EFM32HG Reference Manual.

²The maximum SDA hold time (t_{HD,DAT}) needs to be met only when the device does not stretch the low time of SCL (t_{LOW}).

³When transmitting data, this number is guaranteed only when I2Cn_CLKDIV < ((3450*10⁻⁹ [s] * f_{HPPERCLK} [Hz]) - 5).

Table 3.18. I2C Fast-mode (Fm)

Symbol	Parameter	Min	Typ	Max	Unit
f _{SCL}	SCL clock frequency	0		400 ¹	kHz
t _{LOW}	SCL clock low time	1.3			µs
t _{HIGH}	SCL clock high time	0.6			µs
t _{SU,DAT}	SDA set-up time	100			ns
t _{HD,DAT}	SDA hold time	8		900 ^{2,3}	ns
t _{SU,STA}	Repeated START condition set-up time	0.6			µs
t _{HD,STA}	(Repeated) START condition hold time	0.6			µs
t _{SU,STO}	STOP condition set-up time	0.6			µs
t _{BUF}	Bus free time between a STOP and START condition	1.3			µs

¹For the minimum HPPERCLK frequency required in Fast-mode, see the I2C chapter in the EFM32HG Reference Manual.

²The maximum SDA hold time (t_{HD,DAT}) needs to be met only when the device does not stretch the low time of SCL (t_{LOW}).

³When transmitting data, this number is guaranteed only when I2Cn_CLKDIV < ((900*10⁻⁹ [s] * f_{HPPERCLK} [Hz]) - 5).

Table 3.19. I2C Fast-mode Plus (Fm+)

Symbol	Parameter	Min	Typ	Max	Unit
f _{SCL}	SCL clock frequency	0		1000 ¹	kHz
t _{LOW}	SCL clock low time	0.5			µs
t _{HIGH}	SCL clock high time	0.26			µs
t _{SU,DAT}	SDA set-up time	50			ns
t _{HD,DAT}	SDA hold time	8			ns
t _{SU,STA}	Repeated START condition set-up time	0.26			µs
t _{HD,STA}	(Repeated) START condition hold time	0.26			µs
t _{SU,STO}	STOP condition set-up time	0.26			µs
t _{BUF}	Bus free time between a STOP and START condition	0.5			µs

¹For the minimum HPPERCLK frequency required in Fast-mode Plus, see the I2C chapter in the EFM32HG Reference Manual.

3.13 USB

The USB hardware in the EFM32HG308 passes all tests for USB 2.0 Full Speed certification. The test report will be distributed with application note "AN0046 - USB Hardware Design Guide" when ready.

Table 3.20. USB

Symbol	Parameter	Condition	Min	Typ	Max	Unit
V _{USBOUT}	USB regulator output voltage		3.1	3.4	3.7	V
I _{USBOUT}	USB regulator output current	BIASPROG=0, T _{AMB} =25°C	55.7	79.4	104.1	mA
		BIASPROG=1, T _{AMB} =25°C	66.0	95.9	126.4	mA
		BIASPROG=2, T _{AMB} =25°C	94.6	146.5	188.1	mA
		BIASPROG=3, T _{AMB} =25°C	80.4	128.3	176.0	mA

3.14 Digital Peripherals

Table 3.21. Digital Peripherals

Symbol	Parameter	Condition	Min	Typ	Max	Unit
I _{USART}	USART current	USART idle current, clock enabled		7.5		μA/ MHz
I _{LEUART}	LEUART current	LEUART idle current, clock enabled		150		nA
I _{I2C}	I2C current	I2C idle current, clock enabled		6.25		μA/ MHz
I _{TIMER}	TIMER current	TIMER_0 idle current, clock enabled		8.75		μA/ MHz
I _{PCNT}	PCNT current	PCNT idle current, clock enabled		100		nA
I _{RTC}	RTC current	RTC idle current, clock enabled		100		nA
I _{GPIO}	GPIO current	GPIO idle current, clock enabled		5.31		μA/ MHz
I _{PRS}	PRS current	PRS idle current		2.81		μA/ MHz
I _{DMA}	DMA current	Clock enable		8.12		μA/ MHz

4 Pinout and Package

Note

Please refer to the application note "AN0002 EFM32 Hardware Design Considerations" for guidelines on designing Printed Circuit Boards (PCB's) for the EFM32HG308.

4.1 Pinout

The EFM32HG308 pinout is shown in Figure 4.1 (p. 38) and Table 4.1 (p. 38). Alternate locations are denoted by "#" followed by the location number (Multiple locations on the same pin are split with "/"). Alternate locations can be configured in the LOCATION bitfield in the *_ROUTE register in the module in question.

Figure 4.1. EFM32HG308 Pinout (top view, not to scale)

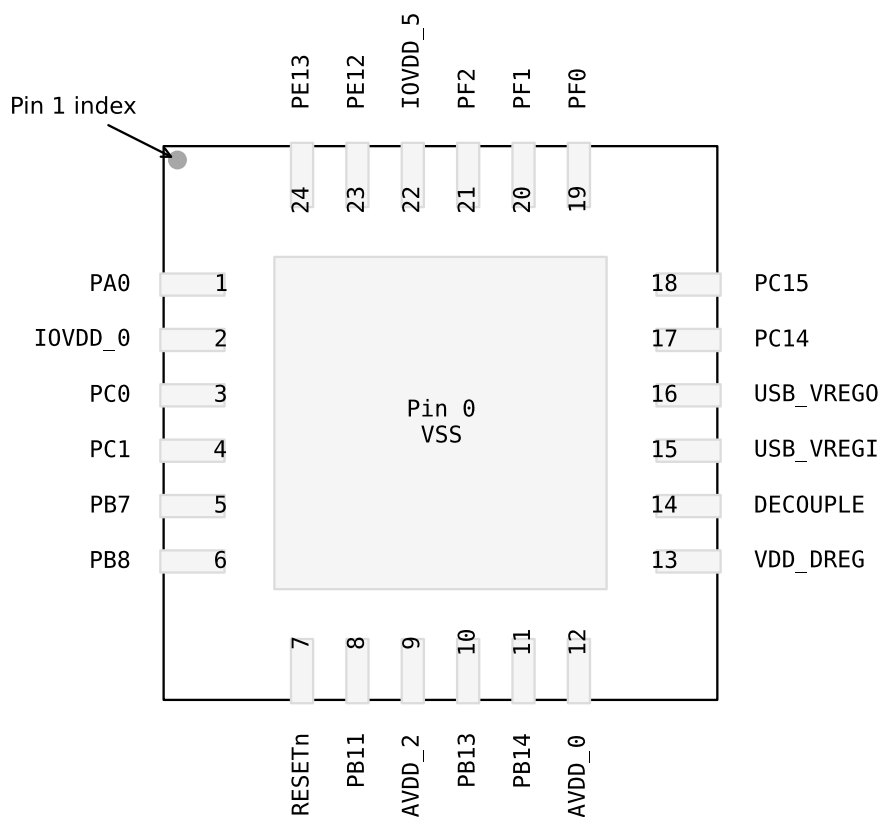

Table 4.1. Device Pinout

QFN24 Pin# and Name		Pin Alternate Functionality / Description			
Pin #	Pin Name	Analog	Timers	Communication	Other
0	VSS	Ground.			
1	PA0		TIM0_CC1 #6 TIM0_CC0 #0/1/4 PCNT0_S0IN #4	USB_DMPU #0 US1_RX #4 LEU0_RX #4 I2C0_SDA #0	PRS_CH0 #0 PRS_CH3 #3 GPIO_EM4WU0

QFN24 Pin# and Name		Pin Alternate Functionality / Description			
Pin #	Pin Name	Analog	Timers	Communication	Other
2	IOVDD_0	Digital IO power supply 0.			
3	PC0	ACMP0_CH0	TIM0_CC1 #4 PCNT0_S0IN #2	US0_TX #5/6 US1_TX #0 US1_CS #5 I2C0_SDA #4	PRS_CH2 #0
4	PC1	ACMP0_CH1	TIM0_CC2 #4 PCNT0_S1IN #2	US0_RX #5/6 US1_TX #5 US1_RX #0 I2C0_SCL #4	PRS_CH3 #0
5	PB7	LFXTAL_P	TIM1_CC0 #3	US0_TX #4 US1_CLK #0	
6	PB8	LFXTAL_N	TIM1_CC1 #3	US0_RX #4 US1_CS #0	
7	RESETn	Reset input, active low. To apply an external reset source to this pin, it is required to only drive this pin low during reset, and let the internal pull-up ensure that reset is released.			
8	PB11		TIM1_CC2 #3 PCNT0_S1IN #4	US1_CLK #4	CMU_CLK1 #3 ACMP0_O #3
9	AVDD_2	Analog power supply 2.			
10	PB13	HFXTAL_P		US0_CLK #4/5 LEU0_TX #1	
11	PB14	HFXTAL_N		US0_CS #4/5 LEU0_RX #1	
12	AVDD_0	Analog power supply 0.			
13	VDD_DREG	Power supply for on-chip voltage regulator.			
14	DECOUPLE	Decouple output for on-chip voltage regulator. An external capacitance of size C _{DECOUPLE} is required at this pin.			
15	USB_VREGI				
16	USB_VREGO				
17	PC14		TIM0_CDT1 #1/6 TIM1_CC1 #0 PCNT0_S1IN #0	US0_CS #3 US1_CS #3/4 LEU0_TX #5 USB_DM	PRS_CH0 #2
18	PC15		TIM0_CDT2 #1/6 TIM1_CC2 #0	US0_CLK #3 US1_CLK #3 LEU0_RX #5 USB_DP	PRS_CH1 #2
19	PF0		TIM0_CC0 #5	US1_CLK #2 LEU0_TX #3 I2C0_SDA #5	DBG_SWCLK #0 BOOT_TX
20	PF1		TIM0_CC1 #5	US1_CS #2 LEU0_RX #3 I2C0_SCL #5	DBG_SWIO #0 GPIO_EM4WU3 BOOT_RX
21	PF2		TIM0_CC2 #5/6 TIM2_CC0 #3	US1_TX #4 LEU0_TX #4	CMU_CLK0 #3 PRS_CH0 #3 GPIO_EM4WU4
22	IOVDD_5	Digital IO power supply 5.			
23	PE12		TIM1_CC2 #1 TIM2_CC1 #3	US0_RX #3 US0_CLK #0/6 I2C0_SDA #6	CMU_CLK1 #2 PRS_CH1 #3
24	PE13		TIM2_CC2 #3	US0_TX #3 US0_CS #0/6 I2C0_SCL #6	ACMP0_O #0 PRS_CH2 #3 GPIO_EM4WU5

4.2 Alternate Functionality Pinout

A wide selection of alternate functionality is available for multiplexing to various pins. This is shown in Table 4.2 (p. 40). The table shows the name of the alternate functionality in the first column, followed by columns showing the possible LOCATION bitfield settings.

Note

Some functionality, such as analog interfaces, do not have alternate settings or a LOCATION bitfield. In these cases, the pinout is shown in the column corresponding to LOCATION 0.

Table 4.2. Alternate functionality overview

Alternate	LOCATION							Description
	0	1	2	3	4	5	6	
ACMP0_CH0	PC0							Analog comparator ACMP0, channel 0.
ACMP0_CH1	PC1							Analog comparator ACMP0, channel 1.
ACMP0_O	PE13			PB11				Analog comparator ACMP0, digital output.
BOOT_RX	PF1							Bootloader RX.
BOOT_TX	PF0							Bootloader TX.
CMU_CLK0				PF2				Clock Management Unit, clock output number 0.
CMU_CLK1			PE12	PB11				Clock Management Unit, clock output number 1.
DBG_SWCLK	PF0							Debug-interface Serial Wire clock input. Note that this function is enabled to pin out of reset, and has a built-in pull down.
DBG_SWDIO	PF1							Debug-interface Serial Wire data input / output. Note that this function is enabled to pin out of reset, and has a built-in pull up.
GPIO_EM4WU0	PA0							Pin can be used to wake the system up from EM4
GPIO_EM4WU3	PF1							Pin can be used to wake the system up from EM4
GPIO_EM4WU4	PF2							Pin can be used to wake the system up from EM4
GPIO_EM4WU5	PE13							Pin can be used to wake the system up from EM4
HFX TAL_N	PB14							High Frequency Crystal negative pin. Also used as external optional clock input pin.
HFX TAL_P	PB13							High Frequency Crystal positive pin.
I2C0_SCL					PC1	PF1	PE13	I2C0 Serial Clock Line input / output.
I2C0_SDA	PA0				PC0	PF0	PE12	I2C0 Serial Data input / output.
LEU0_RX		PB14		PF1	PA0	PC15		LEUART0 Receive input.
LEU0_TX		PB13		PF0	PF2	PC14		LEUART0 Transmit output. Also used as receive input in half duplex communication.
LFXTAL_N	PB8							Low Frequency Crystal (typically 32.768 kHz) negative pin. Also used as an optional external clock input pin.
LFXTAL_P	PB7							Low Frequency Crystal (typically 32.768 kHz) positive pin.
PCNT0_S0IN			PC0		PA0			Pulse Counter PCNT0 input number 0.
PCNT0_S1IN	PC14		PC1		PB11			Pulse Counter PCNT0 input number 1.
PRS_CH0	PA0		PC14	PF2				Peripheral Reflex System PRS, channel 0.
PRS_CH1			PC15	PE12				Peripheral Reflex System PRS, channel 1.
PRS_CH2	PC0			PE13				Peripheral Reflex System PRS, channel 2.
PRS_CH3	PC1			PA0				Peripheral Reflex System PRS, channel 3.

Alternate	LOCATION							Description
	0	1	2	3	4	5	6	
TIM0_CC0	PA0	PA0			PA0	PF0		Timer 0 Capture Compare input / output channel 0.
TIM0_CC1					PC0	PF1	PA0	Timer 0 Capture Compare input / output channel 1.
TIM0_CC2					PC1	PF2	PF2	Timer 0 Capture Compare input / output channel 2.
TIM0_CDT11		PC14					PC14	Timer 0 Complimentary Deat Time Insertion channel 1.
TIM0_CDT12		PC15					PC15	Timer 0 Complimentary Deat Time Insertion channel 2.
TIM1_CC0				PB7				Timer 1 Capture Compare input / output channel 0.
TIM1_CC1	PC14			PB8				Timer 1 Capture Compare input / output channel 1.
TIM1_CC2	PC15	PE12		PB11				Timer 1 Capture Compare input / output channel 2.
TIM2_CC0				PF2				Timer 2 Capture Compare input / output channel 0.
TIM2_CC1				PE12				Timer 2 Capture Compare input / output channel 1.
TIM2_CC2				PE13				Timer 2 Capture Compare input / output channel 2.
US0_CLK	PE12			PC15	PB13	PB13	PE12	USART0 clock input / output.
US0_CS	PE13			PC14	PB14	PB14	PE13	USART0 chip select input / output.
US0_RX				PE12	PB8	PC1	PC1	USART0 Asynchronous Receive. USART0 Synchronous mode Master Input / Slave Output (MISO).
US0_TX				PE13	PB7	PC0	PC0	USART0 Asynchronous Transmit. Also used as receive input in half duplex communication. USART0 Synchronous mode Master Output / Slave Input (MOSI).
US1_CLK	PB7		PF0	PC15	PB11			USART1 clock input / output.
US1_CS	PB8		PF1	PC14	PC14	PC0		USART1 chip select input / output.
US1_RX	PC1				PA0			USART1 Asynchronous Receive. USART1 Synchronous mode Master Input / Slave Output (MISO).
US1_TX	PC0				PF2	PC1		USART1 Asynchronous Transmit. Also used as receive input in half duplex communication. USART1 Synchronous mode Master Output / Slave Input (MOSI).
USB_DM	PC14							USB D- pin.
USB_DMPU	PA0							USB D- Pullup control.
USB_DP	PC15							USB D+ pin.
USB_VREGI	USB_VREGI							USB Input to internal 3.3 V regulator
USB_VREGO	USB_VREGO							USB Decoupling for internal 3.3 V USB regulator and regulator output

4.3 GPIO Pinout Overview

The specific GPIO pins available in *EFM32HG308* is shown in Table 4.3 (p. 42) . Each GPIO port is organized as 16-bit ports indicated by letters A through F, and the individual pin on this port is indicated by a number from 15 down to 0.

Table 4.3. GPIO Pinout

Port	Pin 15	Pin 14	Pin 13	Pin 12	Pin 11	Pin 10	Pin 9	Pin 8	Pin 7	Pin 6	Pin 5	Pin 4	Pin 3	Pin 2	Pin 1	Pin 0
Port A	-	-	-	-	-	-	-	-	-	-	-	-	-	-	-	PA0
Port B	-	PB14	PB13	-	PB11	-	-	PB8	PB7	-	-	-	-	-	-	-
Port C	PC15	PC14	-	-	-	-	-	-	-	-	-	-	-	-	PC1	PC0
Port D	-	-	-	-	-	-	-	-	-	-	-	-	-	-	-	-
Port E	-	-	PE13	PE12	-	-	-	-	-	-	-	-	-	-	-	-
Port F	-	-	-	-	-	-	-	-	-	-	-	-	-	PF2	PF1	PF0

4.4 QFN24 Package

Figure 4.2. QFN24

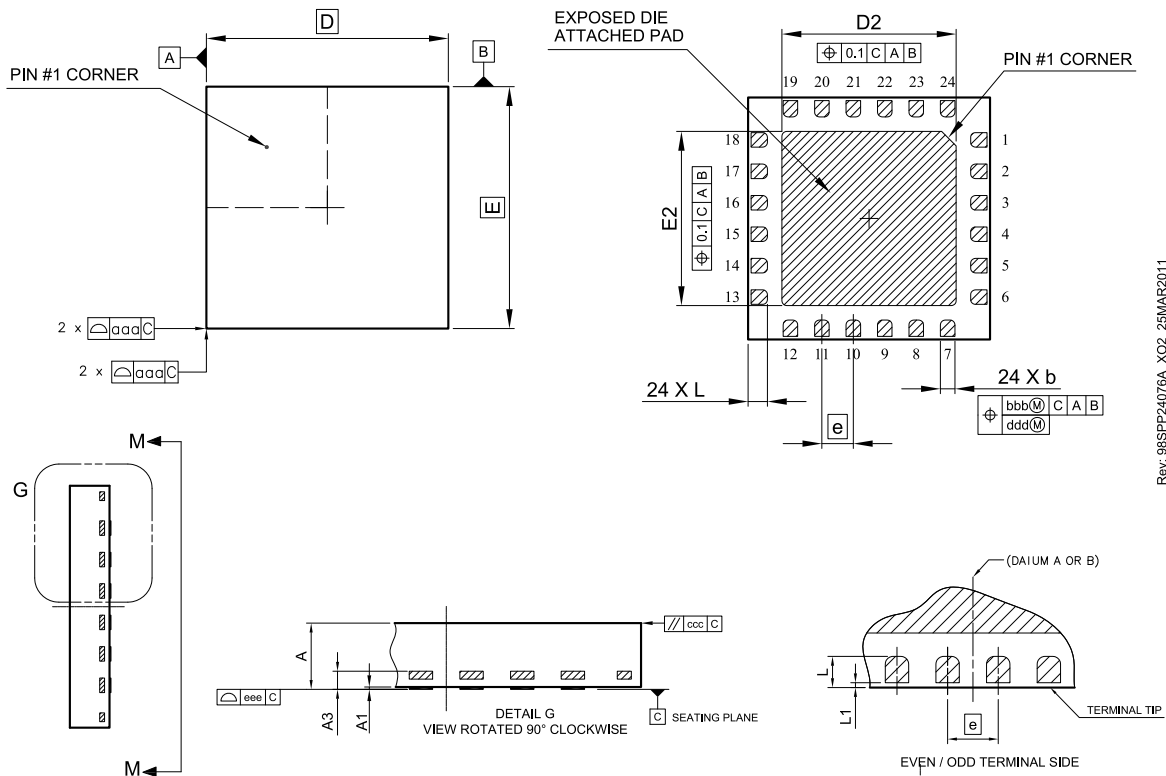

Note:

1. Dimensioning & tolerancing confirm to ASME Y14.5M-1994.
2. All dimensions are in millimeters. Angles are in degrees.
3. Dimension 'b' applies to metallized terminal and is measured between 0.25 mm and 0.30 mm from the terminal tip. Dimension L1 represents terminal full back from package edge up to 0.1 mm is acceptable.
4. Coplanarity applies to the exposed heat slug as well as the terminal.
5. Radius on terminal is optional

Table 4.4. QFN24 (Dimensions in mm)

Symbol	A	A1	A3	b	D	E	D2	E2	e	L	L1	aaa	bbb	ccc	ddd	eee
Min	0.80	0.00		0.25			3.50	3.50		0.35	0.00					
Nom	0.85	-	0.203 REF	0.30	5.00 BSC	5.00 BSC	3.60	3.60	0.65 BSC	0.40		0.10	0.10	0.10	0.05	0.08
Max	0.90	0.05		0.35			3.70	3.70		0.45	0.10					

The QFN24 package uses matte-Sn post plated leadframe.

All EFM32 packages are RoHS compliant and free of Bromine (Br) and Antimony (Sb).

For additional Quality and Environmental information, please see:
<http://www.silabs.com/support/quality/pages/default.aspx>

5 PCB Layout and Soldering

5.1 Recommended PCB Layout

Figure 5.1. QFN24 PCB Land Pattern

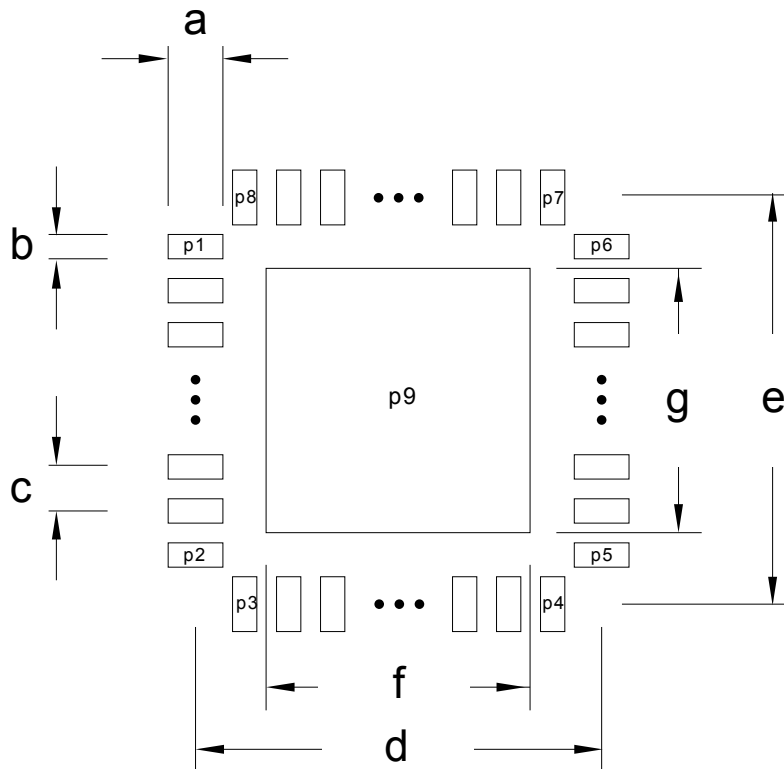

Table 5.1. QFN24 PCB Land Pattern Dimensions (Dimensions in mm)

Symbol	Dim. (mm)	Symbol	Pin number	Symbol	Pin number
a	0.80	P1	1	P8	24
b	0.30	P2	6	P9	25
c	0.65	P3	7	-	-
d	5.00	P4	12	-	-
e	5.00	P5	13	-	-
f	3.60	P6	18	-	-
g	3.60	P7	19	-	-

Figure 5.2. QFN24 PCB Solder Mask

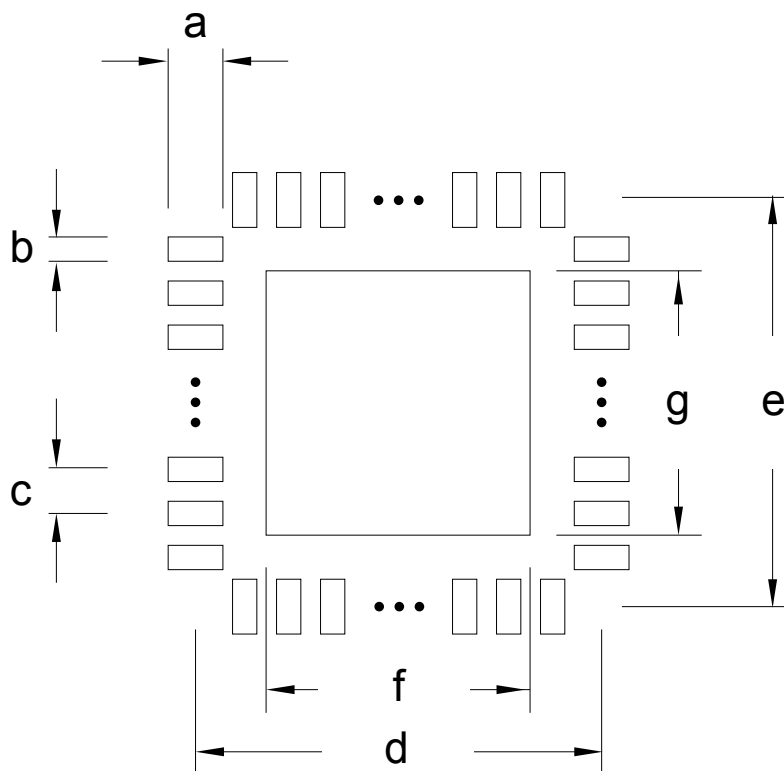

Table 5.2. QFN24 PCB Solder Mask Dimensions (Dimensions in mm)

Symbol	Dim. (mm)	Symbol	Dim. (mm)
a	0.92	e	5.00
b	0.42	f	3.72
c	0.65	g	3.72
d	5.00	-	-

Figure 5.3. QFN24 PCB Stencil Design

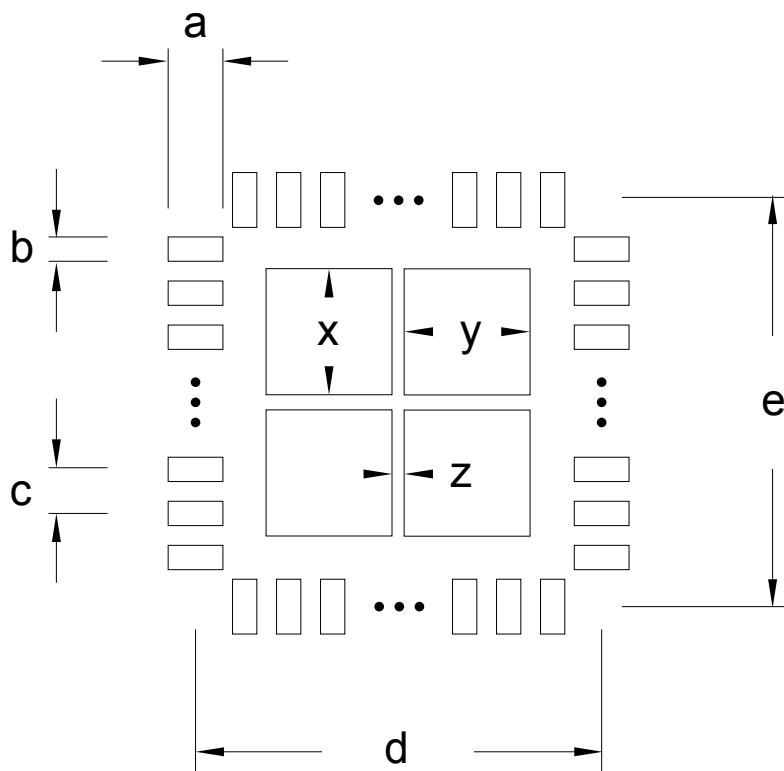

Table 5.3. QFN24 PCB Stencil Design Dimensions (Dimensions in mm)

Symbol	Dim. (mm)	Symbol	Dim. (mm)
a	0.60	e	5.00
b	0.25	x	1.00
c	0.65	y	1.00
d	5.00	z	0.50

1. The drawings are not to scale.
2. All dimensions are in millimeters.
3. All drawings are subject to change without notice.
4. The PCB Land Pattern drawing is in compliance with IPC-7351B.
5. Stencil thickness 0.125 mm.
6. For detailed pin-positioning, see Figure 4.2 (p. 42) .

5.2 Soldering Information

The latest IPC/JEDEC J-STD-020 recommendations for Pb-Free reflow soldering should be followed.

Place as many and as small as possible vias underneath each of the solder patches under the ground pad.

6 Chip Marking, Revision and Errata

6.1 Chip Marking

In the illustration below package fields and position are shown.

Figure 6.1. Example Chip Marking (top view)

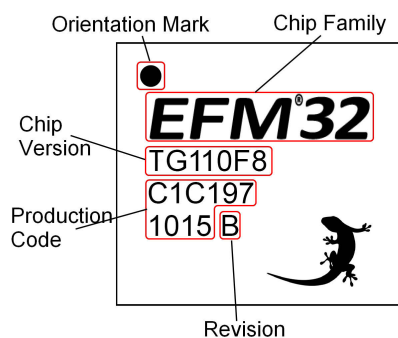

6.2 Revision

The revision of a chip can be determined from the "Revision" field in Figure 6.1 (p. 47) .

6.3 Errata

Please see the errata document for EFM32HG308 for description and resolution of device erratas. This document is available in Simplicity Studio and online at:

<http://www.silabs.com/support/pages/document-library.aspx?p=MCUs--32-bit>

7 Revision History

7.1 Revision 1.00

December 4th, 2015

Updated all specs with results of full characterization.

Updated part number to revision B.

Added the USB electrical specifications table.

7.2 Revision 0.91

May 6th, 2015

Updated current consumption table for energy modes.

Updated GPIO max leakage current.

Updated startup time for HFXO and LFXO.

Updated current consumption for HFRCO and LFRCO.

Updated ADC current consumption.

Updated IDAC characteristics tables.

Updated ACMP internal resistance.

Updated VCMP current consumption.

7.3 Revision 0.90

March 16th, 2015

Note

This datasheet revision applies to a product under development. It's characteristics and specifications are subject to change without notice.

Corrected EM2 current consumption condition in Electrical Characteristics section.

Updated GPIO electrical characteristics.

Updated Max ESR_{HFXO} value for Crystal Frequency of 25 MHz.

Updated LFRCO plots.

Updated HFRCO table and plots.

Updated ADC table and temp sensor plot.

Added DMA current in Digital Peripherals section.

Updated block diagram.

Updated Package dimensions table.

Corrected leadframe type to matte-Sn.

7.4 Revision 0.20

December 11th, 2014

Preliminary Release.

A Disclaimer and Trademarks

A.1 Disclaimer

Silicon Laboratories intends to provide customers with the latest, accurate, and in-depth documentation of all peripherals and modules available for system and software implementers using or intending to use the Silicon Laboratories products. Characterization data, available modules and peripherals, memory sizes and memory addresses refer to each specific device, and "Typical" parameters provided can and do vary in different applications. Application examples described herein are for illustrative purposes only. Silicon Laboratories reserves the right to make changes without further notice and limitation to product information, specifications, and descriptions herein, and does not give warranties as to the accuracy or completeness of the included information. Silicon Laboratories shall have no liability for the consequences of use of the information supplied herein. This document does not imply or express copyright licenses granted hereunder to design or fabricate any integrated circuits. The products must not be used within any Life Support System without the specific written consent of Silicon Laboratories. A "Life Support System" is any product or system intended to support or sustain life and/or health, which, if it fails, can be reasonably expected to result in significant personal injury or death. Silicon Laboratories products are generally not intended for military applications. Silicon Laboratories products shall under no circumstances be used in weapons of mass destruction including (but not limited to) nuclear, biological or chemical weapons, or missiles capable of delivering such weapons.

A.2 Trademark Information

Silicon Laboratories Inc., Silicon Laboratories, Silicon Labs, SiLabs and the Silicon Labs logo, CMEMS[®], EFM, EFM32, EFR, Energy Micro, Energy Micro logo and combinations thereof, "the world's most energy friendly microcontrollers", Ember[®], EZLink[®], EZMac[®], EZRadio[®], EZRadioPRO[®], DSPLL[®], ISO-modem[®], Precision32[®], ProSLIC[®], SiPHY[®], USBXpress[®] and others are trademarks or registered trademarks of Silicon Laboratories Inc. ARM, CORTEX, Cortex-M3 and THUMB are trademarks or registered trademarks of ARM Holdings. Keil is a registered trademark of ARM Limited. All other products or brand names mentioned herein are trademarks of their respective holders.

B Contact Information

Silicon Laboratories Inc.

400 West Cesar Chavez

Austin, TX 78701

Please visit the Silicon Labs Technical Support web page:

<http://www.silabs.com/support/pages/contacttechnicalsupport.aspx>

and register to submit a technical support request.

Table of Contents

1. Ordering Information	2
2. System Summary	3
2.1. System Introduction	3
2.2. Configuration Summary	6
2.3. Memory Map	7
3. Electrical Characteristics	8
3.1. Test Conditions	8
3.2. Absolute Maximum Ratings	8
3.3. General Operating Conditions	8
3.4. Current Consumption	9
3.5. Transition between Energy Modes	17
3.6. Power Management	17
3.7. Flash	18
3.8. General Purpose Input Output	18
3.9. Oscillators	27
3.10. Analog Comparator (ACMP)	33
3.11. Voltage Comparator (VCMP)	35
3.12. I2C	35
3.13. USB	36
3.14. Digital Peripherals	37
4. Pinout and Package	38
4.1. Pinout	38
4.2. Alternate Functionality Pinout	40
4.3. GPIO Pinout Overview	41
4.4. QFN24 Package	42
5. PCB Layout and Soldering	44
5.1. Recommended PCB Layout	44
5.2. Soldering Information	46
6. Chip Marking, Revision and Errata	47
6.1. Chip Marking	47
6.2. Revision	47
6.3. Errata	47
7. Revision History	48
7.1. Revision 1.00	48
7.2. Revision 0.91	48
7.3. Revision 0.90	48
7.4. Revision 0.20	49
A. Disclaimer and Trademarks	50
A.1. Disclaimer	50
A.2. Trademark Information	50
B. Contact Information	51
B.1.	51

List of Figures

2.1. Block Diagram	3
2.2. EFM32HG308 Memory Map with largest RAM and Flash sizes	7
3.1. EM0 Current consumption while executing prime number calculation code from flash with HFRCO running at 24 MHz	11
3.2. EM0 Current consumption while executing prime number calculation code from flash with HFRCO running at 21 MHz	11
3.3. EM0 Current consumption while executing prime number calculation code from flash with HFRCO running at 14 MHz	12
3.4. EM0 Current consumption while executing prime number calculation code from flash with HFRCO running at 11 MHz	12
3.5. EM0 Current consumption while executing prime number calculation code from flash with HFRCO running at 6.6 MHz	13
3.6. EM1 Current consumption with all peripheral clocks disabled and HFRCO running at 24 MHz	13
3.7. EM1 Current consumption with all peripheral clocks disabled and HFRCO running at 21 MHz	14
3.8. EM1 Current consumption with all peripheral clocks disabled and HFRCO running at 14 MHz	14
3.9. EM1 Current consumption with all peripheral clocks disabled and HFRCO running at 11 MHz	15
3.10. EM1 Current consumption with all peripheral clocks disabled and HFRCO running at 6.6 MHz	15
3.11. EM2 current consumption. RTC prescaled to 1kHz, 32.768 kHz LFRCO.	16
3.12. EM3 current consumption.	16
3.13. EM4 current consumption.	17
3.14. Typical Low-Level Output Current, 2V Supply Voltage	21
3.15. Typical High-Level Output Current, 2V Supply Voltage	22
3.16. Typical Low-Level Output Current, 3V Supply Voltage	23
3.17. Typical High-Level Output Current, 3V Supply Voltage	24
3.18. Typical Low-Level Output Current, 3.8V Supply Voltage	25
3.19. Typical High-Level Output Current, 3.8V Supply Voltage	26
3.20. Calibrated LFRCO Frequency vs Temperature and Supply Voltage	28
3.21. Calibrated HFRCO 1 MHz Band Frequency vs Supply Voltage and Temperature	29
3.22. Calibrated HFRCO 7 MHz Band Frequency vs Supply Voltage and Temperature	30
3.23. Calibrated HFRCO 11 MHz Band Frequency vs Supply Voltage and Temperature	30
3.24. Calibrated HFRCO 14 MHz Band Frequency vs Supply Voltage and Temperature	30
3.25. Calibrated HFRCO 21 MHz Band Frequency vs Supply Voltage and Temperature	31
3.26. ACMP Characteristics, Vdd = 3V, Temp = 25°C, FULLBIAS = 0, HALFBIAS = 1	34
4.1. EFM32HG308 Pinout (top view, not to scale)	38
4.2. QFN24	42
5.1. QFN24 PCB Land Pattern	44
5.2. QFN24 PCB Solder Mask	45
5.3. QFN24 PCB Stencil Design	46
6.1. Example Chip Marking (top view)	47

List of Tables

1.1. Ordering Information	2
2.1. Configuration Summary	6
3.1. Absolute Maximum Ratings	8
3.2. General Operating Conditions	8
3.3. Current Consumption	9
3.4. Energy Modes Transitions	17
3.5. Power Management	18
3.6. Flash	18
3.7. GPIO	18
3.8. LFXO	27
3.9. HFXO	27
3.10. LFRCO	28
3.11. HFRCO	29
3.12. AUXHFRCO	31
3.13. USHFRCO	32
3.14. ULFRCO	32
3.15. ACMP	33
3.16. VCMP	35
3.17. I2C Standard-mode (Sm)	35
3.18. I2C Fast-mode (Fm)	36
3.19. I2C Fast-mode Plus (Fm+)	36
3.20. USB	36
3.21. Digital Peripherals	37
4.1. Device Pinout	38
4.2. Alternate functionality overview	40
4.3. GPIO Pinout	42
4.4. QFN24 (Dimensions in mm)	43
5.1. QFN24 PCB Land Pattern Dimensions (Dimensions in mm)	44
5.2. QFN24 PCB Solder Mask Dimensions (Dimensions in mm)	45
5.3. QFN24 PCB Stencil Design Dimensions (Dimensions in mm)	46

List of Equations

3.1. Total ACMP Active Current	33
3.2. VCMP Trigger Level as a Function of Level Setting	35

silabs.com



ZERO
ARM Cortex-M0+



TINY
ARM Cortex-M3



GECKO
ARM Cortex-M3



LEOPARD
ARM Cortex-M3



GIANT
ARM Cortex-M3



WONDER
ARM Cortex-M4

