

PLEASE CHECK WWW.MOLEX.COM FOR LATEST PART INFORMATION

Part Number: [5030911421](#)
Status: **Active**
Overview: [iGrid Wire-to-Board Dual-Row System](#)
Description: 2.00mm Pitch iGrid Wire-to-Board Header, Dual Row, Vertical, Gold (Au) Plating, with PCB Locator, 14 Circuits

Documents:

Drawing (PDF)	Packaging Specification 5030919200-SPK-200 (PDF)
Product Specification 5016460000-PS-000 (PDF)	RoHS Certificate of Compliance (PDF)
Application Specification 5016460000-A00 (PDF)	Product Literature (PDF)
Application Specification 5016460000-A01 (PDF)	

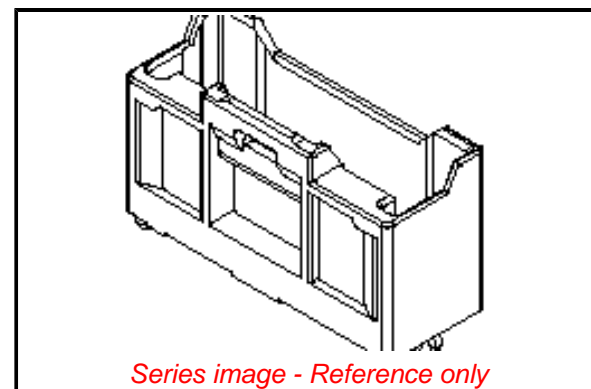

Agency Certification

CSA	LR19880
UL	E29179

General

Product Family	PCB Headers
Series	503091
Application	Signal, Wire-to-Board
Overview	iGrid Wire-to-Board Dual-Row System
Product Literature Order No	987650-1973
Product Name	iGrid
UPC	800756915944

Physical

Breakaway	No
Circuits (Loaded)	14
Circuits (maximum)	14
Color - Resin	Black
Durability (mating cycles max)	30
First Mate / Last Break	No
Flammability	94V-0
Glow-Wire Capable	No
Keying to Mating Part	Yes
Lock to Mating Part	Yes
Material - Metal	Brass
Material - Plating Mating	Gold
Material - Plating Termination	Gold
Material - Resin	Nylon
Net Weight	830.000/mg
Number of Rows	2
Orientation	Vertical
PC Tail Length	3.20mm
PCB Locator	Yes
PCB Retention	None
PCB Thickness - Recommended	1.20mm, 1.60mm
Packaging Type	Tray
Pitch - Mating Interface	2.00mm
Plating min - Mating	0.100µm
Plating min - Termination	0.100µm
Polarized to Mating Part	Yes
Polarized to PCB	Yes
Stackable	No
Surface Mount Compatible (SMC)	No
Temperature Range - Operating	-40° to +105°C
Termination Interface: Style	Through Hole

EU ELV

Not Relevant

EU RoHS

Compliant

REACH SVHC

Not Contained Per -
ED/61/2018 (27 June
2018)

Halogen-Free

Status

Not Low-Halogen

Need more information on product environmental compliance?

Email productcompliance@molex.com
Please visit the [Contact Us](#) section for any non-product compliance questions.

China ROHS	Green Image
ELV	Not Relevant
RoHS Phthalates	Not Contained

Search Parts in this Series

[503091](#) Series

Mates With

[501646](#) Housing

Unmated Height	12.00mm
Electrical	
Current - Maximum per Contact	2.0A
Voltage - Maximum	250V AC (RMS)/DC

Material Info

Reference - Drawing Numbers

Application Specification	5016460000-A00, 5016460000-A01
Packaging Specification	5030919200-SPK-200
Product Specification	5016460000-PS-000
Sales Drawing	5030910000-SD-000

This document was generated on 08/20/2018

PLEASE CHECK WWW.MOLEX.COM FOR LATEST PART INFORMATION