

KEMET, PHBC, Choke, 43 uH, 20%

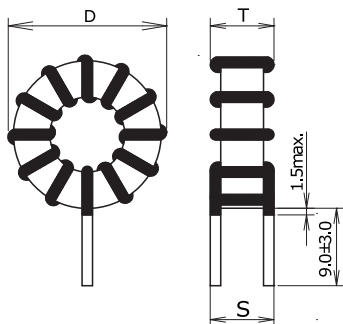

General Information	
Series:	PHBC
Style:	Through-Hole Toroid
Description:	Normal Mode Choke Coil. AC Line Filter.
Features:	Switching Power Supply Outlet, DC-DC Converter, Phase Compensation, Noise Solution
RoHS:	Yes
Lead:	Wire Leads
Core:	Ferrite
Miscellaneous:	20 (K) Temperature Rise Max.

Dimensions	
D	17mm MAX
T	9.1mm MAX
S	7mm NOM
LL	9mm +/-3mm
G	1.5mm MAX
Wire Size	0.6mm

Specifications	
Inductance:	43 uH (0.1 MHz)
Inductance Tolerance:	20%
Temperature Range:	-40/+125C
Rated Temperature:	125C
Current:	2 A (MAX)

Packaging Specifications	
Weight:	5 g
Packaging:	Tray
Packaging Quantity:	700