

PLEASE CHECK WWW.MOLEX.COM FOR LATEST PART INFORMATION

Part Number: [0430450620](#)
Status: **Active**
Overview: [Micro-Fit 3.0 Connector System Product Family](#)
Description: [Micro-Fit 3.0 Vertical Header, 3.00mm Pitch, Dual Row, 6 Circuits, with Solder Tab, Gold, Glow-Wire Capable, Black](#)

Documents:

3D Model	Product Specification TS-43045-002-001 (PDF)
Drawing (PDF)	Product Specification TS-46235-001-001 (PDF)
Product Specification PS-43045 (PDF)	Packaging Specification PK-70873-05XX-003 (PDF)
Product Specification PS-43045-001 (PDF)	RoHS Certificate of Compliance (PDF)
Product Specification TS-43045-001-001 (PDF)	Product Literature (PDF)

Agency Certification

CSA	LR19980
UL	E29179

General

Product Family	PCB Headers
Series	43045
Application	Power, Wire-to-Board
Comments	<p>High Temperature Square Pin Solder Type</p> <p>This Molex product is manufactured from material that has the following ratings, tested by independent agencies: a) A Glow Wire Ignition Temperature (GWIT) of at least 775 deg C per IEC 60695-2-13. b) A Glow Wire Flammability Index (GWFI) above 850 deg C per IEC 60695-2-12. and hence complies with the requirements set out in the International Standard IEC 60335-1 5th edition - household and similar electrical appliances - safety, section 30 Resistance to heat and fire. The customers using this product must determine its suitability for use in their particular application through testing or other acceptable means as described in end-product glow-wire flammability test standard IEC 60695-2-11 and any applicable product end-use standard(s). If it is determined during the customer's evaluation of suitability, that higher performance is required, please contact Molex for possible product options.</p>

Overview	Micro-Fit 3.0 Connector System Product Family
Product Literature Order No	987650-5984
Product Name	Micro-Fit 3.0
UPC	800753816244

Physical

Breakaway	No
Circuits (Loaded)	6
Circuits (maximum)	6
Color - Resin	Black
Durability (mating cycles max)	30
Flammability	94V-0
Glow-Wire Capable	Yes
Mated Height	17.64mm
Material - Metal	Brass
Material - Plating Mating	Gold

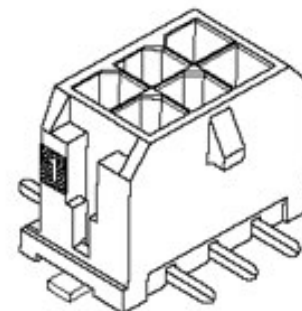

Series image - Reference only

EU ELV

Not Relevant

EU RoHS

Compliant

REACH SVHC

Not Contained Per - ED/61/2018 (27 June 2018)

Halogen-Free

Status

Low-Halogen

For more information, please visit [Contact US](#)

China ROHS

ELV

RoHS Phthalates

China RoHS

Green Image

Not Relevant

Not Contained

Search Parts in this Series

[43045 Series](#)

Mates With

[Micro-Fit 3.0 Receptacle Housing 43025](#)
[Micro-Fit 3.0 TPA Receptacle Housing 172952](#)

Material - Plating Termination	Tin
Material - Resin	High Temperature Thermoplastic
Net Weight	1.214/g
Number of Rows	2
Orientation	Vertical
PCB Locator	Yes
PCB Retention	Yes
PCB Thickness - Recommended	1.60mm
Packaging Type	Embossed Tape on Reel
Pitch - Mating Interface	3.00mm
Plating min - Mating	0.762µm
Polarized to PCB	Yes
Shrouded	Fully
Stackable	No
Surface Mount Compatible (SMC)	N/A
Temperature Range - Operating	-40° to +105°C
Termination Interface: Style	Surface Mount

Electrical

Current - Maximum per Contact	8.5A
Voltage - Maximum	600V

Solder Process Data

Duration at Max. Process Temperature (seconds)	030
Lead-free Process Capability	REFLOW
Max. Cycles at Max. Process Temperature	003
Process Temperature max. C	260

Material Info

Reference - Drawing Numbers

Packaging Specification	PK-70873-05XX-003
Product Specification	PS-43045, PS-43045-001, TS-43045-001-001, TS-43045-002-001, TS-46235-001-001
Sales Drawing	SD-43045-007-001
Symbol/Footprint Data	SYM-43045-0618

This document was generated on 10/26/2018

PLEASE CHECK WWW.MOLEX.COM FOR LATEST PART INFORMATION