

PLEASE CHECK WWW.MOLEX.COM FOR LATEST PART INFORMATION

Part Number: [0432024101](#)
Status: **Active**
Overview: [Magnetic and Modular Jacks and Plugs](#)
Description: [Modular Jack, Right-Angle, Low Profile, 4/4](#)

Documents:

3D Model	Product Specification TS-43202-002-001 (PDF)
Drawing (PDF)	Packaging Specification PK-43202-003 (PDF)
Product Specification PS-43202-001-001 (PDF)	RoHS Certificate of Compliance (PDF)

Agency Certification

CSA	LR19980
UL	E107635

General

Product Family	Modular Jacks/Plugs
Series	43202
Comments	Enhanced panel grounding tabs
Component Type	PCB Jack
Magnetic	No
Overview	Magnetic and Modular Jacks and Plugs
Performance Category	3, 4
Power over Ethernet (PoE)	N/A
Product Name	Modular Jack 4/4
UPC	800754378437

Physical

Color - Resin	Black
Durability (mating cycles max)	500
Flammability	94V-0
Inverted / Top Latch	No
Jack Height	11.58mm
Lightpipes/LEDs	None
Material - Metal	Phosphor Bronze
Material - Plating Mating	Gold
Material - Plating Termination	Tin
Material - Resin	High Temperature Thermoplastic
Net Weight	1.768/g
Orientation	Right Angle (Side Entry)
PCB Retention	Yes
PCB Thickness - Recommended	1.57mm
Packaging Type	Tray
Pitch - Mating Interface	1.02mm
Pitch - Termination Interface	1.27mm
Plating min - Mating	1.270µm
Plating min - Termination	2.540µm
Ports	1
Positions / Loaded Contacts	4/4
Surface Mount Compatible (SMC)	Yes
Temperature Range - Operating	-40° to +85°C
Termination Interface: Style	Through Hole
Wire/Cable Type	N/A

Electrical

Current - Maximum per Contact	1.5A
Shielded	No
Voltage - Maximum	150V AC (RMS)

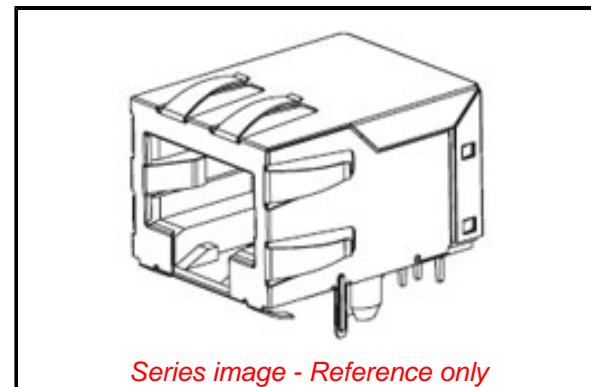

Series image - Reference only

EU ELV

Not Relevant

EU RoHS

Compliant

REACH SVHC

Not Contained Per -
ED/61/2018 (27 June
2018)

Halogen-Free

Status

Not Low-Halogen

For more information, please visit [Contact US](#)

China ROHS

ELV

RoHS Phthalates

Green Image

Not Relevant

Not Contained

Search Parts in this Series

[43202 Series](#)

Mates With

FCC 68 Plugs

Solder Process Data

Duration at Max. Process Temperature (seconds)	005
Lead-free Process Capability	WAVE
Max. Cycles at Max. Process Temperature	001
Process Temperature max. C	260

Material Info

Engineering Number	A432024101
--------------------	------------

Reference - Drawing Numbers

Packaging Specification	PK-43202-003
Product Specification	PS-43202-001-001, TS-43202-002-001
Sales Drawing	SDA-43202

This document was generated on 10/24/2018

PLEASE CHECK WWW.MOLEX.COM FOR LATEST PART INFORMATION