

PLEASE CHECK WWW.MOLEX.COM FOR LATEST PART INFORMATION

Part Number: **0443002200**
Status: **Active**
Overview: Micro-Fit 3.0 Connector System Product Family
Description: Micro-Fit BMI Plug Housing, Dual Row, Panel Mount, 22 Circuits, Black

Documents:

3D Model	Product Specification TS-44300-001-001 (PDF)
Drawing (PDF)	Product Specification TS-46235-001-001 (PDF)
Product Specification PS-44300-001-001 (PDF)	Packaging Specification PK-44300-001-001 (PDF)
Product Specification TS-43045-001-001 (PDF)	RoHS Certificate of Compliance (PDF)
Product Specification TS-43045-002-001 (PDF)	Product Literature (PDF)

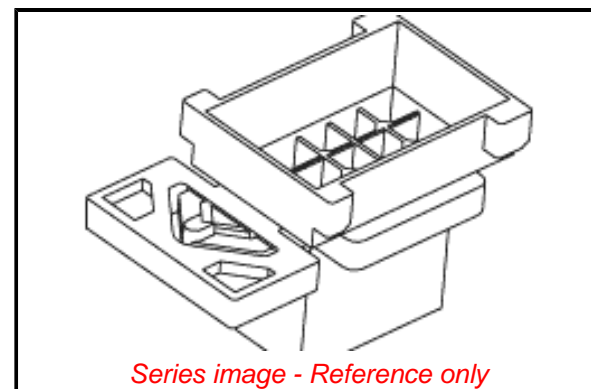

Agency Certification

CSA	LR19980
UL	E29179

General

Product Family	Crimp Housings
Series	44300
Application	Power, Wire-to-Board, Wire-to-Wire
Overview	Micro-Fit 3.0 Connector System Product Family
Product Literature Order No	987650-5984
Product Name	Micro-Fit BMI
UPC	800753281974

Physical

Circuits (maximum)	22
Color - Resin	Black
Flammability	94V-0
Gender	Plug
Glow-Wire Capable	No
Lock to Mating Part	No
Material - Resin	Polyester
Net Weight	4.894/g
Number of Rows	2
Packaging Type	Bag
Panel Mount	Yes
Pitch - Mating Interface	3.00mm
Polarized to Mating Part	Yes
Stackable	No
Temperature Range - Operating	-40° to +105°C

Solder Process Data

Lead-freeProcess Capability	N/A
-----------------------------	-----

Material Info

Reference - Drawing Numbers

Packaging Specification	PK-44300-001-001
Product Specification	PS-44300-001-001, TS-43045-001-001, TS-43045-002-001, TS-44300-001-001, TS-46235-001-001
Sales Drawing	SD-44300-001

EU ELV

Not Relevant

EU RoHS

Compliant

REACH SVHC

Not Contained Per
-ED/01/2018 (15
January 2018)

Halogen-Free

Status

Not Low-Halogen

For more information, please visit [Contact US](#)

China ROHS

ELV

RoHS Phthalates

China RoHS

Green Image

Not Relevant

Not Contained

Search Parts in this Series

[44300 Series](#)

Mates With

[44133](#) , [44764](#) , [44769](#)

Use With

[43031](#) Micro-Fit 3.0 Male Crimp Terminals