

PLEASE CHECK WWW.MOLEX.COM FOR LATEST PART INFORMATION

Part Number: [5023860670](#)
Status: **Active**
Description: 1.25 W/B Sgl R/A Rec Assy 6CktEmbsTpPkg

Documents:

3D Model	Application Specification AS-502380-002-001 (PDF)
Drawing (PDF)	Packaging Specification SPK-502386-001-001 (PDF)
Product Specification PS-502382-001-001 (PDF)	RoHS Certificate of Compliance (PDF)

Agency Certification

UL E29179

General

Product Family	PCB Receptacles
Series	502386
Application	Signal, Wire-to-Board
Product Name	CLIK-Mate
UPC	822350895712

Physical

Circuits (Loaded)	6
Circuits (maximum)	6
Color - Resin	Natural
Durability (mating cycles max)	30
Glow-Wire Capable	No
Guide to Mating Part	Yes
Keying to Mating Part	Yes
Lock to Mating Part	Yes
Mated Height	5.55mm
Material - Metal	Copper Alloy
Material - Plating Mating	Tin
Material - Plating Termination	Tin
Material - Resin	High Temperature Thermoplastic
Net Weight	302.001/mg
Number of Rows	1
Orientation	Right Angle
PCB Locator	No
PCB Retention	Yes
Packaging Type	Embossed Tape on Reel
Pitch - Mating Interface	1.25mm
Pitch - Termination Interface	1.25mm
Plating min - Mating	1.016µm
Plating min - Termination	1.016µm
Polarized to Mating Part	Yes
Polarized to PCB	No
Stackable	No
Temperature Range - Operating	-40° to +105°C
Termination Interface: Style	Surface Mount

Electrical

Current - Maximum per Contact	1.0A
Voltage - Maximum	50V AC (RMS)/DC

Material Info

Reference - Drawing Numbers

Application Specification	AS-502380-002-001
Packaging Specification	SPK-502386-001-001

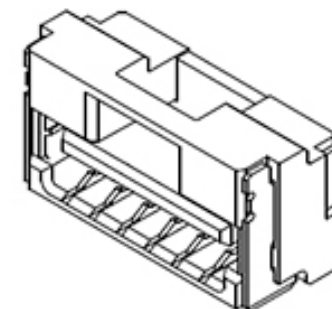

Series image - Reference only

EU ELV

Not Relevant

EU RoHS

Compliant

REACH SVHC

Not Contained Per -
ED/61/2018 (27 June
2018)

Halogen-Free

Status

Not Low-Halogen

For more information, please visit [Contact US](#)

China ROHS

ELV

RoHS Phthalates

China RoHS

Green Image

Not Relevant

Not Contained

Search Parts in this Series

[502386](#) Series

Mates With

[502380](#) CLIK-Mate Housing

This document was generated on 10/18/2018

PLEASE CHECK WWW.MOLEX.COM FOR LATEST PART INFORMATION