

PLEASE CHECK WWW.MOLEX.COM FOR LATEST PART INFORMATION

Part Number: **5024390800**
Status: **Active**
Overview: CLIK-Mate Wire-to-Board Connectors
Description: 2.00mm Pitch CLIK-Mate Wire-to-Board Housing, Single Row, Positive Lock, 8 Circuits, White

Documents:

3D Model	Application Specification AS-502439-002-001 (PDF)
Drawing (PDF)	Packaging Specification 5024399200-200 (PDF)
Product Specification 5024431570-000 (PDF)	RoHS Certificate of Compliance (PDF)
Application Specification AS-502439-001-001 (PDF)	

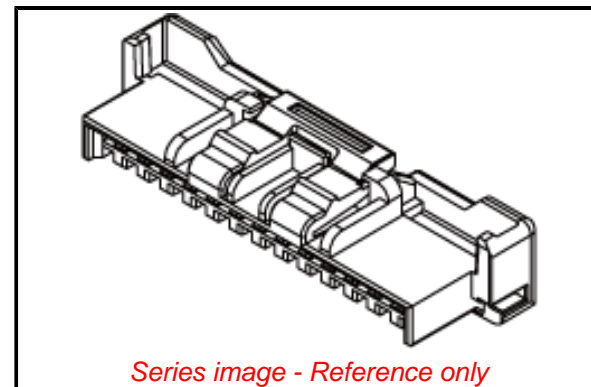

Agency Certification

UL E29179

General

Product Family	Crimp Housings
Series	502439
Application	Signal, Wire-to-Board
Comments	See Product Specification for maximum current rating by circuit size and wire AWG
Overview	CLIK-Mate Wire-to-Board Connectors
Product Name	CLIK-Mate
UPC	822350915861

Physical

Breakaway	No
Circuits (maximum)	8
Color - Resin	White
Gender	Plug
Glow-Wire Capable	No
Keying to Mating Part	Yes
Lock to Mating Part	Yes
Material - Resin	PBT
Net Weight	643.000/mg
Number of Rows	1
Packaging Type	Bag
Panel Mount	No
Pitch - Mating Interface	2.00mm
Polarized to Mating Part	Yes
Stackable	No
Temperature Range - Operating	-40° to +105°C

Electrical

Current - Maximum per Contact 3.0A

Material Info

Reference - Drawing Numbers

Application Specification	AS-502439-001-001, AS-502439-002-001
Packaging Specification	5024399200-200
Product Specification	5024431570-000
Sales Drawing	5024391500-000

EU ELV

Not Relevant

EU RoHS

Compliant

REACH SVHC

Not Contained Per - ED/61/2018 (27 June 2018)

Halogen-Free

Status

Not Low-Halogen

For more information, please visit [Contact US](#)

China ROHS

ELV

RoHS Phthalates

China RoHS

Green Image

Not Relevant

Not Contained

Search Parts in this Series

[502439](#) Series

Mates With

[502443](#) PCB Receptacle Vertical . [502494](#) PCB Receptacle Right Angle

Use With

[502438](#) Crimp Terminal