

**PLEASE CHECK WWW.MOLEX.COM FOR LATEST PART INFORMATION**

**Part Number:** [0533750810](#)  
**Status:** **Active**  
**Overview:** Mini-Lock Wire-to-Board Connector System  
**Description:** 2.50mm Pitch Mini-Lock Wire-to-Board Header, Vertical, Friction and Positive Lock, 8 Circuits

**Documents:**

<a href="#">3D Model</a>	<a href="#">Packaging Specification 533759200-SPK-200 (PDF)</a>
<a href="#">Drawing (PDF)</a>	<a href="#">RoHS Certificate of Compliance (PDF)</a>
<a href="#">Product Specification PS-51103-005-001 (PDF)</a>	<a href="#">Product Literature (PDF)</a>
<a href="#">Product Specification PS-51163-002-001 (PDF)</a>	

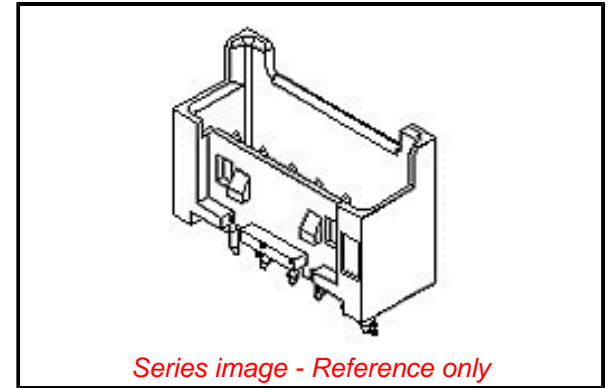

**Agency Certification**

CSA	LR19980
UL	E29179

**General**

Product Family	PCB Headers
Series	<a href="#">53375</a>
Application	Signal, Wire-to-Board
Overview	<a href="#">Mini-Lock Wire-to-Board Connector System</a>
Product Literature Order No	987651-9241
Product Name	Mini-Lock
UPC	800754235174

**Physical**

Breakaway	No
Circuits (Loaded)	8
Circuits (maximum)	8
Color - Resin	Natural
Durability (mating cycles max)	30
First Mate / Last Break	No
Flammability	94V-0
Glow-Wire Capable	No
Guide to Mating Part	No
Keying to Mating Part	None
Lock to Mating Part	Yes
Material - Plating Mating	Tin
Material - Plating Termination	Tin
Material - Resin	Polyester
Net Weight	925.000/mg
Number of Rows	1
Orientation	Vertical
PC Tail Length	3.40mm
PCB Locator	Yes
PCB Retention	Yes
PCB Thickness - Recommended	1.60mm
Packaging Type	Bag
Pitch - Mating Interface	2.50mm
Polarized to Mating Part	Yes
Polarized to PCB	Yes
Shrouded	Fully
Stackable	No
Surface Mount Compatible (SMC)	No
Temperature Range - Operating	-40° to +105°C
Termination Interface: Style	Through Hole

**EU ELV**

**Not Relevant**

**EU RoHS**

**Compliant**

**REACH SVHC**

Not Contained Per -  
ED/61/2018 (27 June  
2018)

**Halogen-Free**

**Status**

**Not Low-Halogen**

For more information, please visit [Contact US](#)

China ROHS

ELV

RoHS Phthalates

**China RoHS**

Green Image

Not Relevant

Not Contained

**Search Parts in this Series**

[53375 Series](#)

**Mates With**

Mini-Lock Wire-to-Board and Wire-to-Wire  
Crimp Terminal [51103](#) , [51102](#) , [51163](#)

**Electrical**

Current - Maximum per Contact 3.0A  
Voltage - Maximum 250V

**Material Info****Reference - Drawing Numbers**

Packaging Specification 533759200-SPK-200  
Product Specification PS-51103-005-001, PS-51163-002-001  
Sales Drawing SD-53375-001

This document was generated on 09/27/2018

**PLEASE CHECK [WWW.MOLEX.COM](http://WWW.MOLEX.COM) FOR LATEST PART INFORMATION**