

**PLEASE CHECK WWW.MOLEX.COM FOR LATEST PART INFORMATION**

**Part Number:** [0755860007](#)  
**Status:** **Active**  
**Overview:** [iPass Connector System](#)  
**Description:** 0.80mm Pitch, iPass I/O Surface Mount Receptacle, Right-Angle, External Application, 68 Circuit, 0.76µm Gold (Au)

**Documents:**

<a href="#">3D Model</a>	<a href="#">Application Specification AS-75586-001-001 (PDF)</a>
<a href="#">Drawing (PDF)</a>	<a href="#">Packaging Specification PK-75586-002 (PDF)</a>
<a href="#">Product Specification PS-75586-001-001 (PDF)</a>	<a href="#">Packaging Specification PK-75586-101 (PDF)</a>
<a href="#">Application Specification AS-170432-0003 (PDF)</a>	<a href="#">RoHS Certificate of Compliance (PDF)</a>

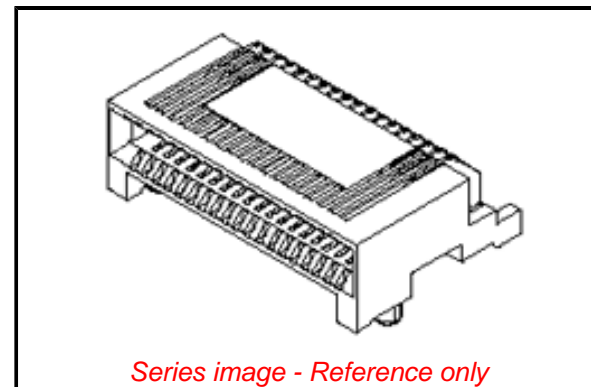

**Agency Certification**

CSA	LR19980
UL	E29179

**General**

Product Family	I/O Connectors
Series	<a href="#">75586</a>
Application	Wire-to-Board
Component Type	Receptacle
Electrical Model	Yes
Overview	<a href="#">iPass Connector System</a>
Product Name	iPass, Mini Multi-Lane, PCI Express
Type	N/A
UPC	822348849550

**Physical**

Boot Color	N/A
Circuits (Loaded)	68
Circuits (maximum)	68
Color - Resin	Black
Durability (mating cycles max)	250
Flammability	94V-0
Gender	Female
Keying to Mating Part	None
Lock to Mating Part	None
Material - Metal	High Performance Alloy (HPA)
Material - Plating Mating	Gold
Material - Plating Termination	Tin
Material - Resin	High Temperature Thermoplastic
Net Weight	1.611/g
Number of Rows	2
Orientation	Right Angle
PCB Locator	Yes
PCB Retention	None
PCB Thickness - Recommended	1.35mm
Packaging Type	Embossed Tape on Reel
Panel Mount	No
Pitch - Mating Interface	0.80mm
Pitch - Termination Interface	0.80mm
Plating min - Mating	0.762µm
Plating min - Termination	2.540µm
Polarized to Mating Part	Yes
Polarized to PCB	Yes
Ports	1
Surface Mount Compatible (SMC)	Yes

**EU ELV**

**Not Relevant**

**EU RoHS**

**Compliant**

**REACH SVHC**

Not Contained Per -  
ED/61/2018 (27 June  
2018)

**Halogen-Free**

**Status**

**Low-Halogen**

For more information, please visit [Contact US](#)

China ROHS

ELV

RoHS Phthalates

**China RoHS**

Green Image

Not Relevant

Not Contained

**Search Parts in this Series**

[75586](#) Series

**Mates With**

[74547](#) iPass Cable Assembly

**Use With**

[74548](#) I/O Connectors

Temperature Range - Operating	-40° to +80°C
Termination Interface: Style	Surface Mount
Waterproof / Dustproof	No
Wire Insulation Diameter	N/A
Wire Size AWG	N/A

**Electrical**

Current - Maximum per Contact	0.5A
Grounding to Panel	N/A
Shielded	No
Voltage - Maximum	30V AC (RMS)/DC

**Solder Process Data**

Duration at Max. Process Temperature (seconds)	020
Lead-free Process Capability	REFLOW
Max. Cycles at Max. Process Temperature	001
Process Temperature max. C	260

**Material Info****Reference - Drawing Numbers**

Application Specification	AS-170432-0003, AS-75586-001-001
Electrical Model Document	EE-75586-001
Packaging Specification	PK-75586-002, PK-75586-101
Product Specification	PS-75586-001-001
S-Parameter Model	SP-75586-001
Sales Drawing	SD-75586-001

This document was generated on 10/08/2018

**PLEASE CHECK [WWW.MOLEX.COM](http://WWW.MOLEX.COM) FOR LATEST PART INFORMATION**