

PLEASE CHECK WWW.MOLEX.COM FOR LATEST PART INFORMATION

Part Number: **5016451420**
Status: **Active**
Overview: iGrid Wire-to-Board Dual-Row System
Description: 2.00mm Pitch iGrid Wire-to-Board Header, Dual Row, Vertical, Tin (Sn) Plating, with PCB Locator, 14 Circuits

Documents:

3D Model	Application Specification 5016460000-A01 (PDF)
Drawing (PDF)	Packaging Specification SPK-501645-001-001 (PDF)
Product Specification PS-501646-001-001 (PDF)	RoHS Certificate of Compliance (PDF)
Application Specification 5016460000-A00 (PDF)	

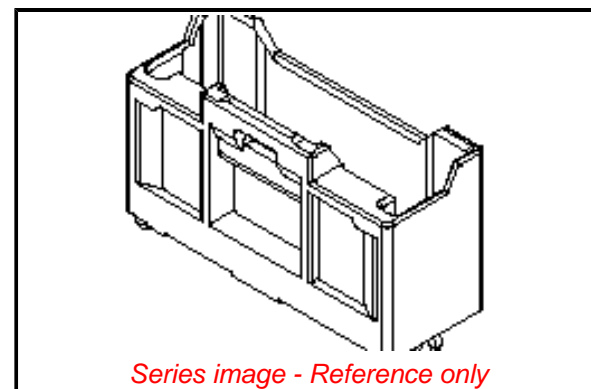

Agency Certification

CSA	LR19980
UL	E29179

General

Product Family	PCB Headers
Series	501645
Application	Signal, Wire-to-Board
Overview	iGrid Wire-to-Board Dual-Row System
Product Name	iGrid
UPC	822350201407

Physical

Breakaway	No
Circuits (Loaded)	14
Circuits (maximum)	14
Color - Resin	Natural
Durability (mating cycles max)	30
First Mate / Last Break	No
Flammability	94V-0
Glow-Wire Capable	No
Keying to Mating Part	Yes
Lock to Mating Part	Yes
Material - Metal	Brass
Material - Plating Mating	Tin
Material - Plating Termination	Tin
Material - Resin	Nylon
Net Weight	923.600/mg
Number of Rows	2
Orientation	Vertical
PC Tail Length	3.20mm
PCB Locator	Yes
PCB Retention	None
PCB Thickness - Recommended	1.20mm, 1.60mm
Packaging Type	Tray
Pitch - Mating Interface	2.00mm
Polarized to Mating Part	Yes
Polarized to PCB	Yes
Stackable	No
Surface Mount Compatible (SMC)	No
Temperature Range - Operating	-40° to +105°C
Termination Interface: Style	Through Hole

Electrical

Current - Maximum per Contact	2.0A
-------------------------------	------

EU ELV

Not Relevant

EU RoHS

Compliant

REACH SVHC

Not Contained Per -
ED/61/2018 (27 June
2018)

Halogen-Free

Status

Not Low-Halogen

For more information, please visit [Contact US](#)

China ROHS

ELV

RoHS Phthalates

China RoHS

Green Image

Not Relevant

Not Contained

Search Parts in this Series

[501645 Series](#)

Mates With

[501646 Housing](#)

Voltage - Maximum

250V AC (RMS)/DC

Material Info

Reference - Drawing Numbers

Application Specification

5016460000-A00, 5016460000-A01

Packaging Specification

SPK-501645-001-001

Product Specification

PS-501646-001-001

Sales Drawing

SD-501645-001

This document was generated on 10/23/2018

PLEASE CHECK WWW.MOLEX.COM FOR LATEST PART INFORMATION