

PLEASE CHECK WWW.MOLEX.COM FOR LATEST PART INFORMATION

Part Number: [5022503591](#)
Status: **Active**
Overview: FFC-FPC (SMT)
Description: 0.30mm Pitch Easy-On BackFlip Type FPC Connector, Right Angle, Surface Mount, Dual Contact Style, 0.90mm Mated Height, 35 Circuits

Documents:

[3D Model](#) [Packaging Specification SPK-502250-001-001 \(PDF\)](#)
[Drawing \(PDF\)](#) [RoHS Certificate of Compliance \(PDF\)](#)
[Product Specification PS-502250-001-001 \(PDF\)](#)

General

Product Family	FFC/FPC Connectors
Series	502250
Comments	Black Actuator
Overview	FFC-FPC (SMT)
Product Name	Easy-On
UPC	800756810188

Physical

Circuits (Loaded)	35
Color - Resin	Natural
Contact Position	Dual
Durability (mating cycles max)	10
Entry Angle	90° Angle
Mated Height	0.90mm
Material - Metal	Copper Alloy
Material - Plating Mating	Gold
Material - Plating Termination	Gold
Material - Resin	Liquid Crystal Polymer
Net Weight	81.954/mg
Number of Rows	1
Orientation	Right Angle
PCB Locator	No
PCB Retention	Yes
Packaging Type	Embossed Tape on Reel
Pitch - Mating Interface	0.30mm
Polarized to PCB	Yes
Stackable	No
Temperature Range - Operating	-40°C to +105°C
Termination Interface: Style	Surface Mount
Wire/Cable Type	FPC only

Electrical

Current - Maximum per Contact	0.2A
Voltage - Maximum	50V AC (RMS)/DC

Material Info

Reference - Drawing Numbers

Packaging Specification	SPK-502250-001-001
Product Specification	PS-502250-001-001
Sales Drawing	5022500000-000, 5022501000-000

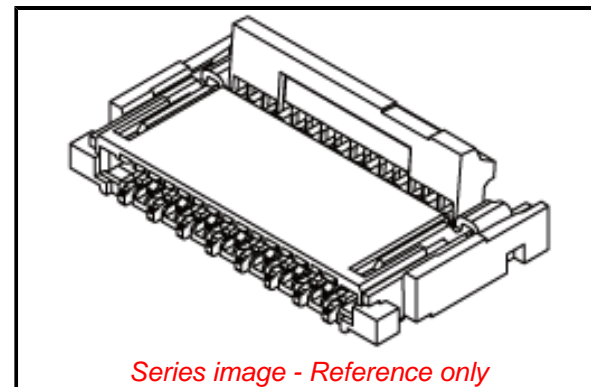

Series image - Reference only

EU ELV

Not Relevant

EU RoHS

Compliant

REACH SVHC

Not Contained Per -
ED/30/2017 (7 July
2017)

Halogen-Free

Status

Not Low-Halogen

Need more information on product environmental compliance?

Email productcompliance@molex.com
Please visit the [Contact Us](#) section for any non-product compliance questions.

China ROHS	Green Image
ELV	Not Relevant
RoHS Phthalates	Not Contained

Search Parts in this Series

[502250 Series](#)