

**PLEASE CHECK WWW.MOLEX.COM FOR LATEST PART INFORMATION**

**Part Number:** [5023860870](#)  
**Status:** **Active**  
**Description:** 1.25 W/B Sgl R/A Rec Assy 8CktEmbsTpPkg

**Documents:**

<a href="#">3D Model</a>	<a href="#">Application Specification AS-502380-002-001 (PDF)</a>
<a href="#">Drawing (PDF)</a>	<a href="#">Packaging Specification SPK-502386-001-001 (PDF)</a>
<a href="#">Product Specification PS-502382-001-001 (PDF)</a>	<a href="#">RoHS Certificate of Compliance (PDF)</a>

**Agency Certification**

UL E29179

**General**

Product Family	PCB Receptacles
Series	<a href="#">502386</a>
Application	Signal, Wire-to-Board
Product Name	CLIK-Mate
UPC	822350895736

**Physical**

Circuits (Loaded)	8
Circuits (maximum)	8
Color - Resin	Natural
Durability (mating cycles max)	30
Glow-Wire Capable	No
Guide to Mating Part	Yes
Keying to Mating Part	Yes
Lock to Mating Part	Yes
Mated Height	5.55mm
Material - Metal	Copper Alloy
Material - Plating Mating	Tin
Material - Plating Termination	Tin
Material - Resin	High Temperature Thermoplastic
Net Weight	380.801/mg
Number of Rows	1
Orientation	Right Angle
PCB Locator	No
PCB Retention	Yes
Packaging Type	Embossed Tape on Reel
Pitch - Mating Interface	1.25mm
Pitch - Termination Interface	1.25mm
Plating min - Mating	1.016µm
Plating min - Termination	1.016µm
Polarized to Mating Part	Yes
Polarized to PCB	No
Stackable	No
Temperature Range - Operating	-40° to +105°C
Termination Interface: Style	Surface Mount

**Electrical**

Current - Maximum per Contact	1.0A
Voltage - Maximum	50V AC (RMS)/DC

**Material Info**

**Reference - Drawing Numbers**

Application Specification	AS-502380-002-001
Packaging Specification	SPK-502386-001-001

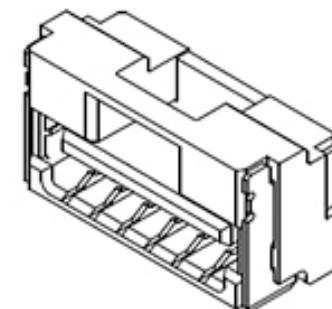

*Series image - Reference only*

**EU ELV**

**Not Relevant**

**EU RoHS**

**Compliant**

**REACH SVHC**

Not Contained Per -  
ED/61/2018 (27 June  
2018)

**Halogen-Free**

**Status**

**Not Low-Halogen**

For more information, please visit [Contact US](#)

China ROHS

ELV

RoHS Phthalates

**China RoHS**

Green Image

Not Relevant

Not Contained

**Search Parts in this Series**

[502386](#) Series

**Mates With**

[502380](#) CLIK-Mate Housing

This document was generated on 10/18/2018

**PLEASE CHECK [WWW.MOLEX.COM](http://WWW.MOLEX.COM) FOR LATEST PART INFORMATION**