

PLEASE CHECK WWW.MOLEX.COM FOR LATEST PART INFORMATION

Part Number: [0901301214](#)
Status: **Active**
Overview: C-Grid III Interconnects
Description: C-Grid III Header, Dual Row, Vertical, Shrouded, Fully Loaded, 14 Circuits, Black, 0.38µm Gold (Au) Selective Plating

Documents:

[3D Model](#) [Packaging Specification PK-91814-005 \(PDF\)](#)
[Drawing \(PDF\)](#) [RoHS Certificate of Compliance \(PDF\)](#)
[Product Specification PS-99020-0001-001 \(PDF\)](#)

Agency Certification

CSA LR19980
 UL E29179

General

Product Family PCB Headers
 Series [90130](#)
 Application Signal, Wire-to-Board
 Overview [C-Grid III Interconnects](#)
 Product Name C-Grid III
 UPC 800754314930

Physical

Breakaway No
 Circuits (Loaded) 14
 Circuits (maximum) 14
 Color - Resin Black
 Durability (mating cycles max) 100
 First Mate / Last Break No
 Flammability 94V-0
 Glow-Wire Capable No
 Guide to Mating Part No
 Keying to Mating Part None
 Lock to Mating Part Yes
 Material - Metal Brass
 Material - Plating Mating Gold
 Material - Plating Termination Tin
 Material - Resin Polyester
 Net Weight 1.693/g
 Number of Rows 2
 Orientation Vertical
 PC Tail Length 2.90mm
 PCB Locator No
 PCB Retention None
 PCB Thickness - Recommended 1.60mm
 Packaging Type Tray
 Pitch - Mating Interface 2.54mm
 Pitch - Termination Interface 2.54mm
 Plating min - Mating 0.381µm
 Plating min - Termination 3.048µm
 Polarized to Mating Part Yes
 Polarized to PCB No
 Shrouded Closed Ends
 Stackable No
 Surface Mount Compatible (SMC) No
 Temperature Range - Operating -55° to +125°C

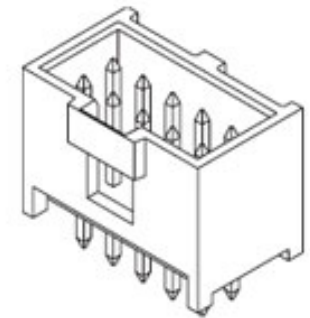

Series image - Reference only

EU ELV

Not Relevant

EU RoHS

Compliant

REACH SVHC

Not Contained Per -
 ED/61/2018 (27 June
 2018)

Halogen-Free

Status

Not Low-Halogen

For more information, please visit [Contact US](#)

China ROHS

ELV

RoHS Phthalates

China RoHS

Green Image

Not Relevant

Not Contained

Search Parts in this Series

[90130](#) Series

Mates With

[90142](#) C-Grid III Crimp Housing

Termination Interface: Style Through Hole

Electrical

Current - Maximum per Contact 3.0A
Voltage - Maximum 350V AC/DC

Solder Process Data

Duration at Max. Process Temperature (seconds) 003
Lead-freeProcess Capability WAVE
Max. Cycles at Max. Process Temperature 001
Process Temperature max. C 235

Material Info

Reference - Drawing Numbers

Packaging Specification PK-91814-005
Product Specification PS-99020-0001-001
Sales Drawing SDA-90130-001

This document was generated on 10/11/2018

PLEASE CHECK WWW.MOLEX.COM FOR LATEST PART INFORMATION