

Cylindrical High-Intensity LED (5 mm)



OVLLx8C7

Features:

- Wide viewing angle
- High-brightness indicator
- Industry standard lead spacing
- Unique lens shape for flexible applications



Description:

The OVLLx8C7 series is designed for superior performance in signage and lighting applications that require wide-angle uniform light output. These devices combine a high-intensity LED with a unique flat-topped T-1 $\frac{1}{2}$ package to provide both high brightness and a wide spatial radiation pattern.

Applications:

- Channel letter and other signage backlighting
- Decorative architectural indoor and outdoor lighting accents
- Industrial and consumer indicators

Part Number	Material	Emitted Color	Intensity Typ. mcd	Lens Color
OVLLB8C7	InGaN	Blue	440	Clear
OVLLG8C7	InGaN	Green	2400	Clear
OVLLR8C7	AlInGaP	Red	900	Clear
OVLLY8C7	AlInGaP	Yellow	980	Clear

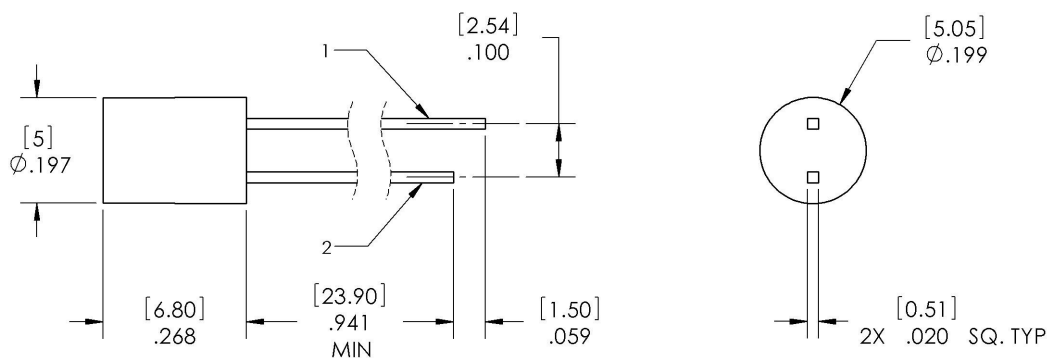

1 ANODE 2 CATHODE DIMENSIONS ARE IN INCHES AND [MILLIMETERS].

TOLERANCES ARE .005 [.12] UNLESS OTHERWISE SPECIFIED.



RoHS

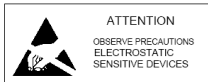

**DO NOT LOOK DIRECTLY
AT LED WITH
UNSHIELDED EYES OR
DAMAGE TO RETINA MAY**

General Note

TT Electronics reserves the right to make changes in product specification without notice or liability. All information is subject to TT Electronics' own data and is considered accurate at time of going to print.

TT Electronics | Optek Technology, Inc.
1645 Wallace Drive, Ste. 130, Carrollton, TX USA 75006 | Ph: +1 972 323 2200
www.ttelectronics.com | sensors@ttelectronics.com

Cylindrical High-Intensity LED (5 mm)



Electrical Specifications

Absolute Maximum Ratings ($T_A = 25^\circ\text{C}$ unless otherwise noted)

Storage Temperature Range		-40 ~ +100° C
Operating Temperature Range		-40 ~ +100° C
Reverse Voltage		5 V
Continuous Forward Current	Blue, Green	25 mA
Continuous Forward Current	Red, Yellow	50 mA
Peak Forward Current (10% Duty Cycle, 1 KHz)		100 mA
Power Dissipation	Blue, Green	100 mW
Power Dissipation	Red, Yellow	120 mW
Lead Soldering Temperature (4 mm from the base of the epoxy bulb) ¹		260° C / 5 seconds
LED Junction Temperature		125° C
Electrostatic Discharge Classification (JEDEC-JESD22-A114F)		Class 1C
Current Linearity vs. Ambient Temperature	Blue, Green	-0.29 mA/° C
Current Linearity vs. Ambient Temperature	Red, Yellow	-0.72 mA/° C

Electrical Characteristics

$T_A = 25^\circ\text{C}$ unless otherwise noted

SYMBOL	PARAMETER	COLOR	MIN	TYP	MAX	UNITS	CONDITIONS
I_V	Luminous Intensity	Blue	295	440	----	mcd	$I_F = 20\text{ mA}$
		Green	1135	2400	----		
		Red	580	900	----		
		Yellow	580	980	----		
V_F	Forward Voltage	Blue, Green	----	3.2	4.0	V	$I_F = 20\text{ mA}$
		Red, Yellow	----	2.0	2.4		
I_R	Reverse Current	Blue, Green	----	----	10	μA	$V_R = 5\text{ V}$
		Red, Yellow					
λ_D	Dominant Wavelength	Blue	460	470	475	nm	$I_F = 20\text{ mA}$
		Green	519	525	531		
		Red	620	623	630		
		Yellow	585	589	595		
20½H-H	50% Power Angle	Blue, Green	----	85	----	deg	$I_F = 20\text{ mA}$
		Red, Yellow	----	100	----		

General Note

TT Electronics reserves the right to make changes in product specification without notice or liability. All information is subject to TT Electronics' own data and is considered accurate at time of going to print.

TT Electronics | Optek Technology, Inc.
1645 Wallace Drive, Ste. 130, Carrollton, TX USA 75006 | Ph: +1 972 323 2200
www.ttelectronics.com | sensors@ttelectronics.com

Cylindrical High-Intensity LED (5 mm)



Typical Electro-Optical Characteristics Curves (BLUE)

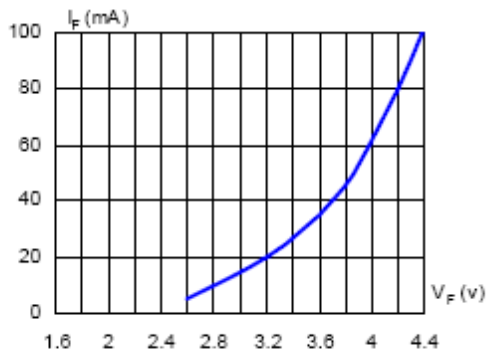

Fig. 1 Forward Current vs Forward Voltage

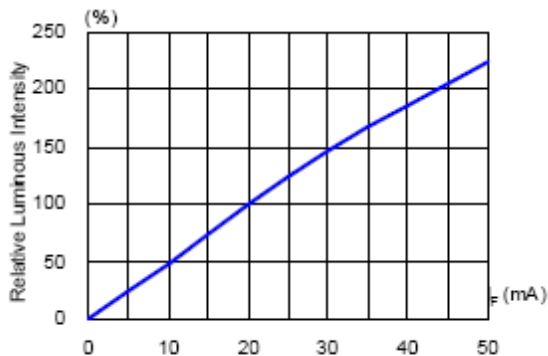

Fig. 2 Luminous Intensity vs. Forward Current

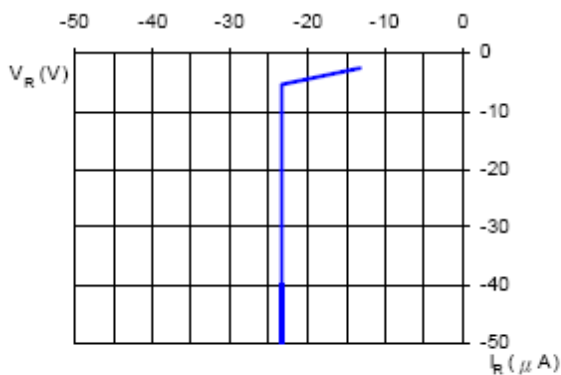

Fig. 3 Reverse Current vs. Reverse Voltage

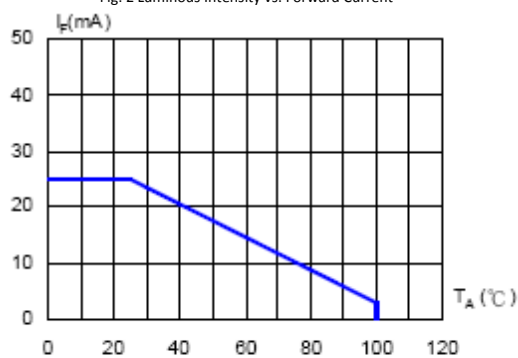

Fig. 4 Allow able Forward Current vs. Ambient Temperature

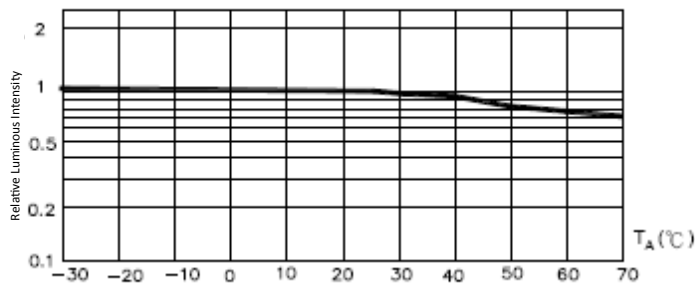

Fig. 5 Luminous Intensity at $I_F + 20mA$ vs. Ambient Temperature

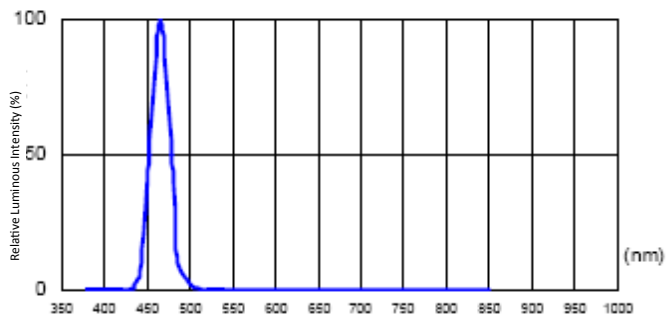

Fig. 6 Relative Luminous Intensity vs. Wavelength

General Note

TT Electronics reserves the right to make changes in product specification without notice or liability. All information is subject to TT Electronics' own data and is considered accurate at time of going to print.

TT Electronics | Optek Technology, Inc.
1645 Wallace Drive, Ste. 130, Carrollton, TX USA 75006 | Ph: +1 972 323 2200
www.ttelectronics.com | sensors@ttelectronics.com

Cylindrical High-Intensity LED (5 mm)



Typical Electro-Optical Characteristics Curves (GREEN)

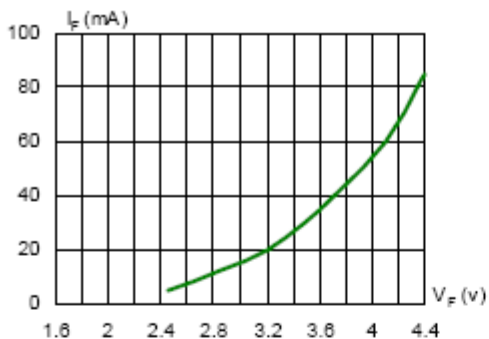

Fig. 1 Forward Current vs. Forward Voltage

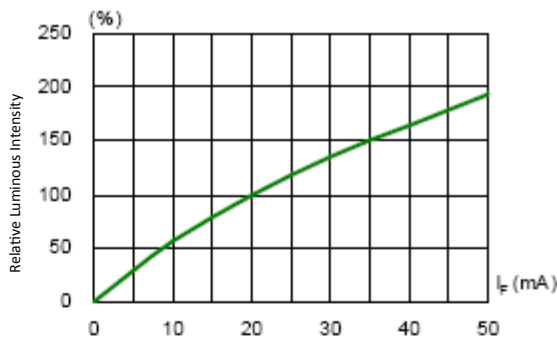

Fig. 2 Luminous Intensity vs. Forward Current

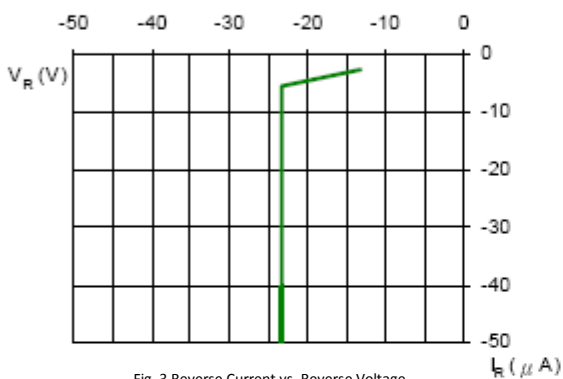

Fig. 3 Reverse Current vs. Reverse Voltage

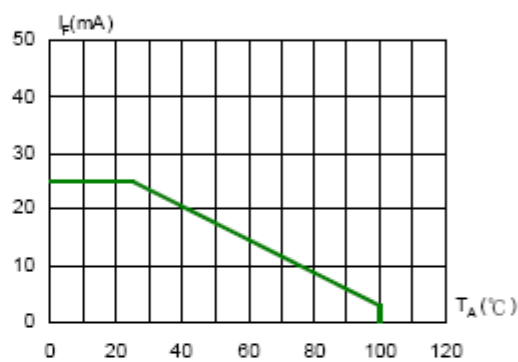

Fig. 4 Allowable Forward Current vs. Ambient Temperature

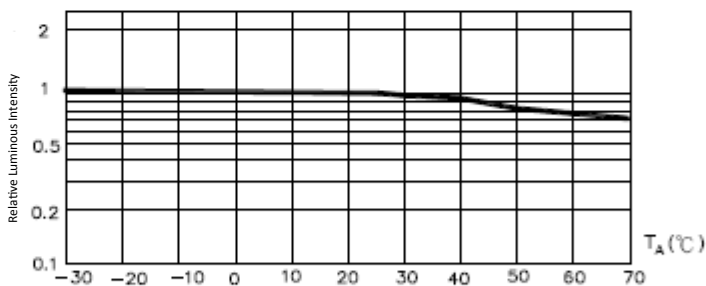

Fig. 5 Luminous Intensity at $I_F + 20mA$ vs. Ambient Temperature

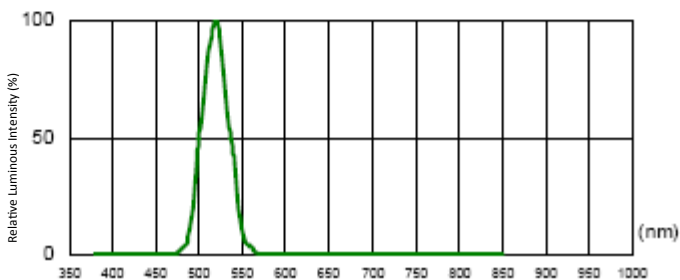

Fig. 6 Relative Luminous Intensity vs. Wavelength

General Note

TT Electronics reserves the right to make changes in product specification without notice or liability. All information is subject to TT Electronics' own data and is considered accurate at time of going to print.

TT Electronics | Optek Technology, Inc.
1645 Wallace Drive, Ste. 130, Carrollton, TX USA 75006 | Ph: +1 972 323 2200
www.ttelectronics.com | sensors@ttelectronics.com

Cylindrical High-Intensity LED (5 mm)



Typical Electro-Optical Characteristics Curves (RED)



Fig. 1 Forward Current vs Forward Voltage

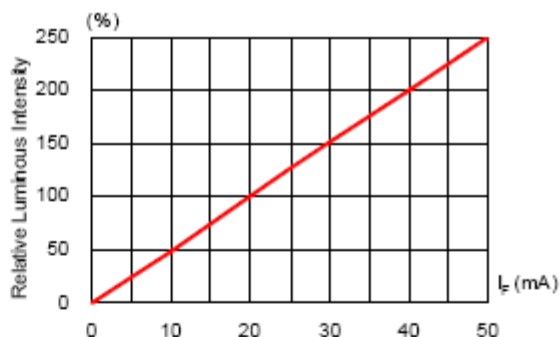

Fig. 2 Luminous Intensity vs. Forward Current

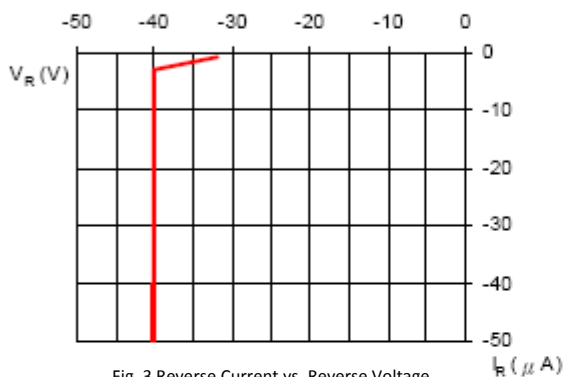

Fig. 3 Reverse Current vs. Reverse Voltage

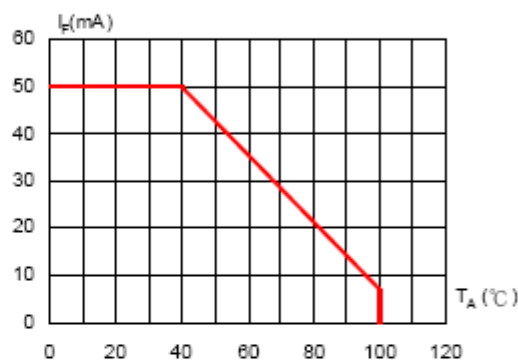

Fig. 4 Allowable Forward Current vs. Ambient Temperature

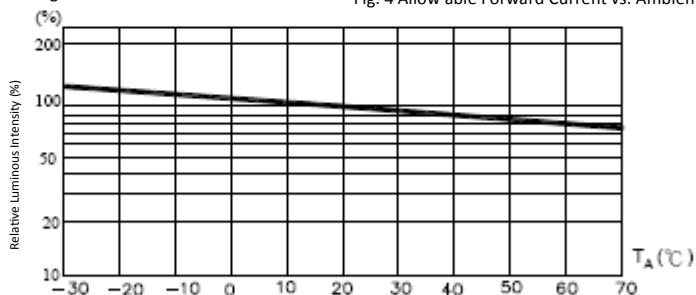

Fig. 5 Luminous Intensity at $I_F=20mA$ vs. Ambient Temperature

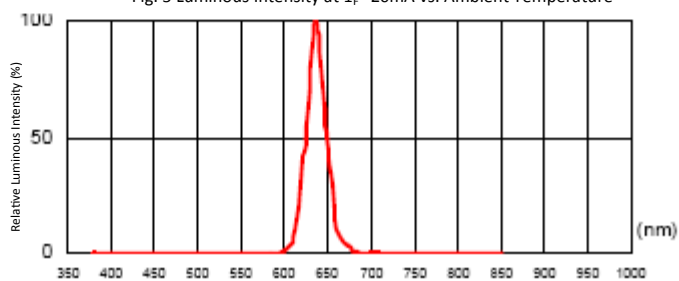

Fig. 6 Relative Luminous Intensity vs. Wavelength

General Note

TT Electronics reserves the right to make changes in product specification without notice or liability. All information is subject to TT Electronics' own data and is considered accurate at time of going to print.

TT Electronics | Optek Technology, Inc.
1645 Wallace Drive, Ste. 130, Carrollton, TX USA 75006 | Ph: +1 972 323 2200
www.ttelectronics.com | sensors@ttelectronics.com

Cylindrical High-Intensity LED (5 mm)



Typical Electro-Optical Characteristics Curves (YELLOW)

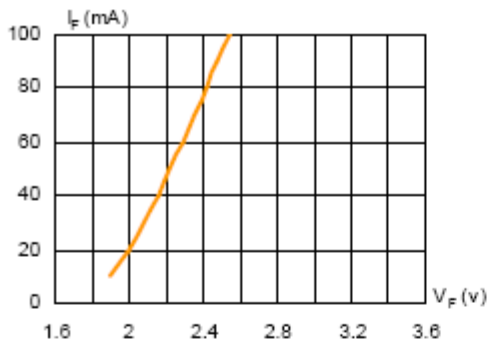

Fig. 1 Forward Current vs. Forward Voltage

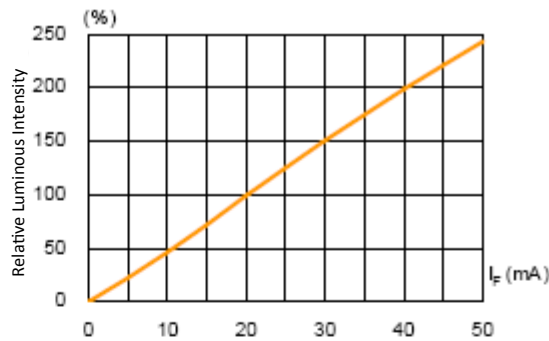

Fig. 2 Luminous Intensity vs. Forward Current

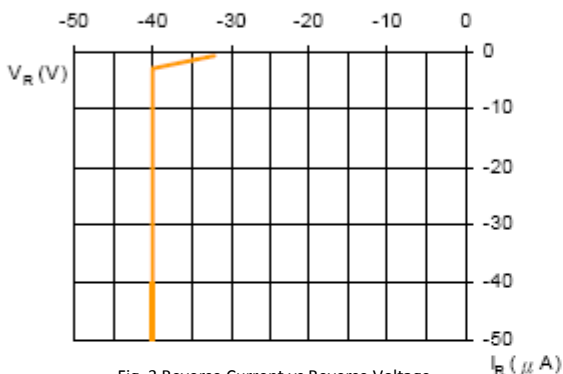

Fig. 3 Reverse Current vs Reverse Voltage

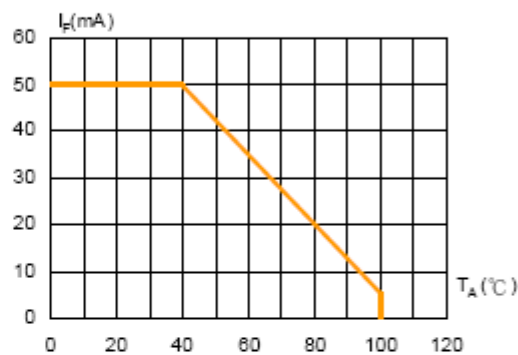

Fig. 4 Allow able Forward Current vs. Ambient Temperature

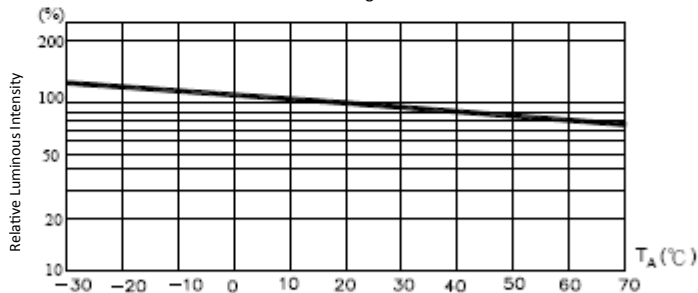

Fig. 5 Luminous Intensity at $I_F=20mA$ vs. Ambient Temperature

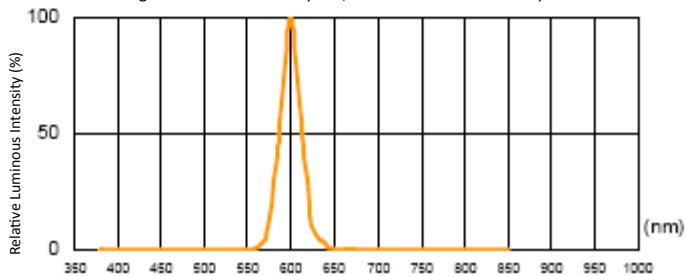

Fig. 6 Relative Luminous Intensity vs. Wavelength

General Note

TT Electronics reserves the right to make changes in product specification without notice or liability. All information is subject to TT Electronics' own data and is considered accurate at time of going to print.

TT Electronics | Optek Technology, Inc.
1645 Wallace Drive, Ste. 130, Carrollton, TX USA 75006 | Ph: +1 972 323 2200
www.ttelectronics.com | sensors@ttelectronics.com

Cylindrical High-Intensity LED (5 mm)



Beam Pattern

BLUE and GREEN

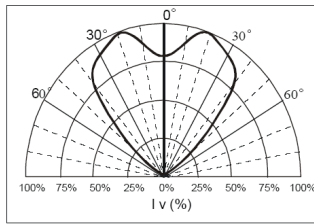

RED and YELLOW

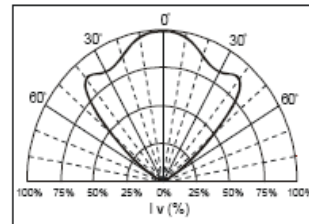

Packaging: 500 pcs per bulk bag with desiccant

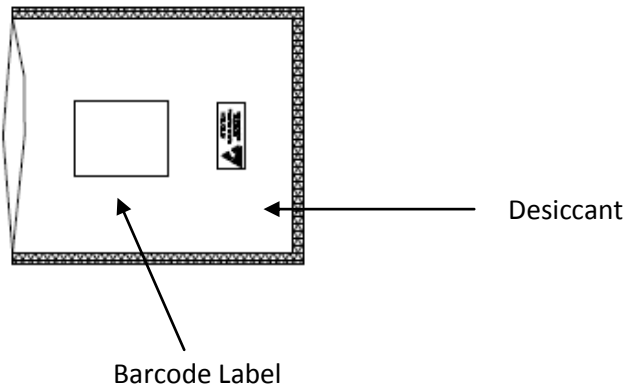

Cylindrical High-Intensity LED (5 mm)



Reliability Test

1. Test Conditions, Acceptable Criteria & Results:

Classification	Test Item	Standard Test Method	Test Conditions	Duration	Unit	Acc / Rej Criteria	Result
Life Test	Operation Life Test (OLT)	MIL-STD-750D Method 1026.3	$T_A=25^{\circ}\text{C}$, $I_F=30\text{mA}$ *	1000 Hrs	100	0 / 1	Pass
Environment Test	High Temperature Storage (HTS)	MIL-STD-750D Method 1032.1	$T_A=100^{\circ}\text{C}$	1000 Hrs	100	0 / 1	Pass
	Low Temperature Storage (LTS)	MIL-STD-750D Method 1032.1	$T_A=-40^{\circ}\text{C}$	1000 Hrs	100	0 / 1	Pass
	Temp. & Humidity with Bias (THB)	MIL-STD-750D Method 103B	$T_A=85^{\circ}\text{C}$, $R_h=85\%$ $I_F=20\text{mA}$ **	500 Hrs	100	0 / 1	Pass
	Thermal Shock Test (TST)	MIL-STD-750D Method 1056.1	$0^{\circ}\text{C} \sim 100^{\circ}\text{C}$ 2min 2min	100 cycles	100	0 / 1	Pass
	Temperature Cycling Test (TCT)	MIL-STD-750D Method 1051.5	$-40^{\circ}\text{C} \sim 25^{\circ}\text{C} \sim 100^{\circ}\text{C} \sim 25^{\circ}\text{C}$ 30min 5min 30min 5min	100 cycles	100	0 / 1	Pass
Mechanical Test	Solderability	MIL-STD-750D Method 2026.4	$235\pm 5^{\circ}\text{C}$, 5 sec.	1 time	20	0 / 1	Pass
	Resistance to Soldering Heat	MIL-STD-750D Method 2031.1	$260\pm 5^{\circ}\text{C}$, 5 sec.	1 time	20	0 / 1	Pass
	Lead Integrity	MIL-STD-750D Method 2036.3	Load 2.5N (0.25kgf) $0^{\circ} \sim 90^{\circ} \sim 0^{\circ}$, bend	3 times	20	0 / 1	Pass

Remark : (*) $I_F=30\text{mA}$ for AlInGaP chip ; $I_F=20\text{mA}$ for InGaN chip

(**) $I_F=20\text{mA}$ for AlInGaP chip ; $I_F=10\text{mA}$ for InGaN chip

2. Failure Criteria ($T_A=25^{\circ}\text{C}$):

Test Item	Symbol	Test Conditions	Criteria for Judgment	
			Min.	Max.
Luminous Intensity	I_V	$I_F=20\text{mA}$	$\text{LSL} \times 0.7$ **	
Forward Voltage	V_F	$I_F=20\text{mA}$		$\text{USL} \times 1.1$ *

(*) USL : Upper Standard Level , (**) LSL : Lower Standard Level