

Product description	Contacts: 8, Connecting cable 5m, male cable connector M12x1 - RJ45-male connector, shielded, IP67
Area	M12-D, M12-X Series 876 X-coding
Order number	79 9723 050 08

Illustration

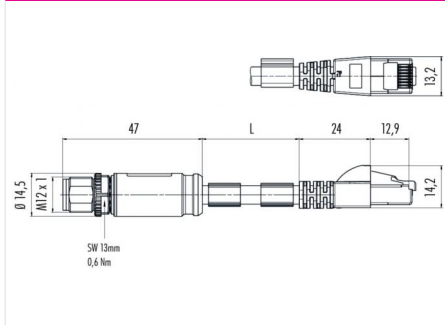

Scale drawing



Contact arrangement

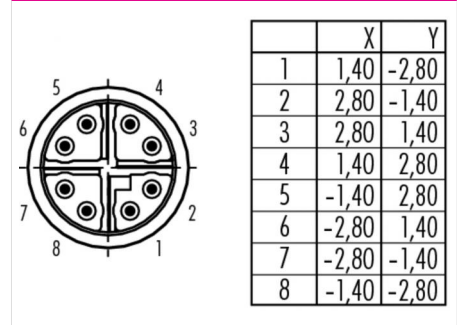

Technical data

General values

Connector design	connecting cord
Connector locking system	bolted
Termination	moulded on cable
Wire gauge (AWG)	4x2xAWG26
Upper limit temperature	85 °C
Lower limit temperature	-40 °C

Cable data

Sheath material	PUR
Single-lead insulation	PE
Single-lead structure	8 x 0,14
Cable diameter	6.2
Conductor resistance	14,5Ω/100 m
Temperature range, moving cable, °C from	-10
Temperature range, moving cable, °C to	60
Temperature range, fixed cable, °C from	-40
Temperature range, fixed cable, °C to	85
Bending radius, fixed cable	≥ 50 mm
Approval 1	UL listed

Electrical values

Rated current (40 °C)	0,5 A
Rated voltage	50V AC, 60V DC V
Pollution degree	3
Overvoltage category	II
Insulating material group	II
Volume resistivity	≤ 15 mΩ
Insulation resistance	>10^8Ω
EMC compliance	shielded
Degree of protection	IP67
Mechanical operation	> 100 Mating cycles

Material

Contact material	CuZn (brass)
Contact plating	Au (gold)
Contact body material	PA
Housing material	PUR

Product description	Contacts: 8, Connecting cable 5m, male cable connector M12x1 - RJ45-male connector, shielded, IP67
Area	M12-D, M12-X Series 876 X-coding
Order number	79 9723 050 08

Security notices

The connectors are designed for use in plant, control system and electrical equipment. The end user is responsible for checking whether the connectors are suitable for use in other applications.

Connectors with degree of protection IP 67 and IP 68 are not suitable for use under water. When used outdoors, the connectors must be separately protected against corrosion. For further information about IP degrees of protection refer to 'Technical support' in the Download Centre.

To lock the cable connector to the equipment connector, the threaded ring is tightened until it is 'finger-tight' (approx. 50 cNm).