

DO NOT SCALE DRAWING

REVISIONS				
ZONE	REV.	DESCRIPTION	DATE	APPROVED
	A	DRAWN	13-06-2013	

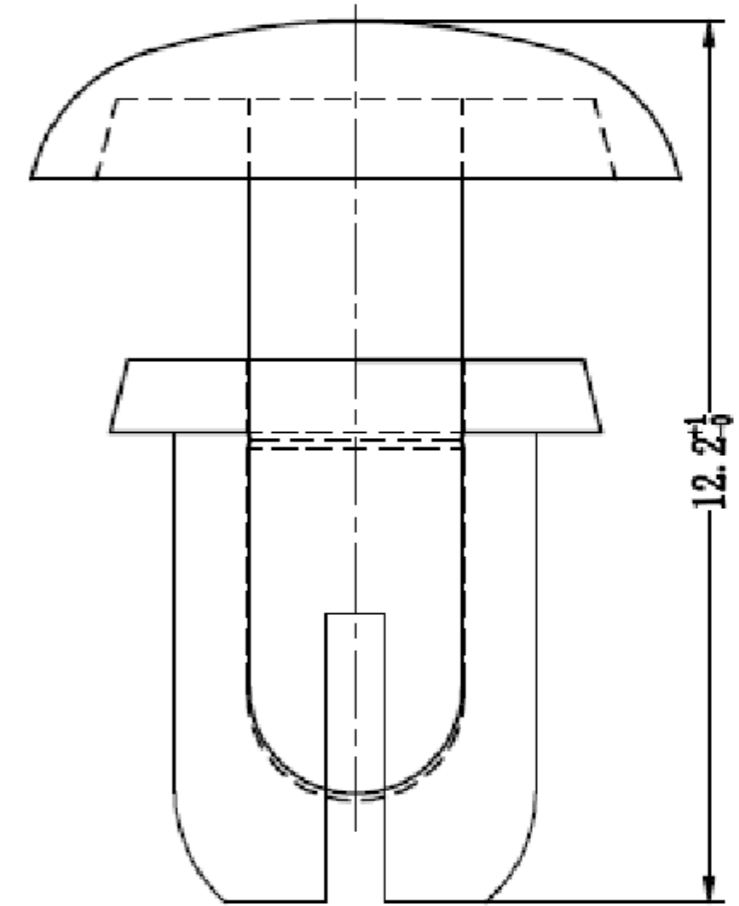
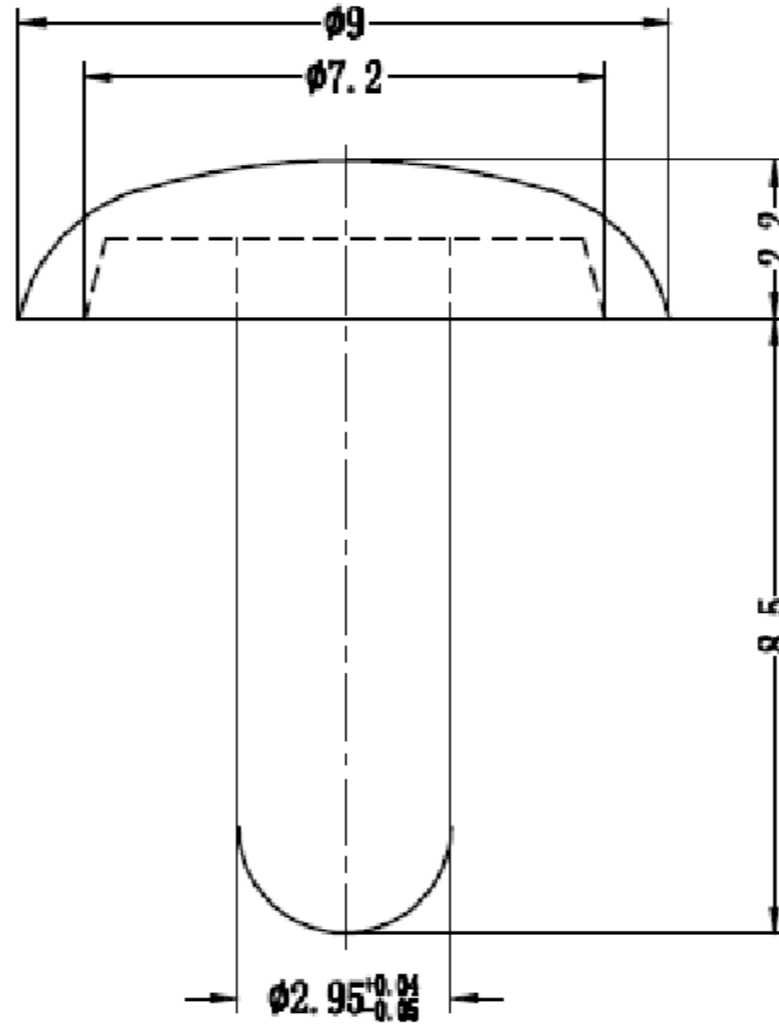
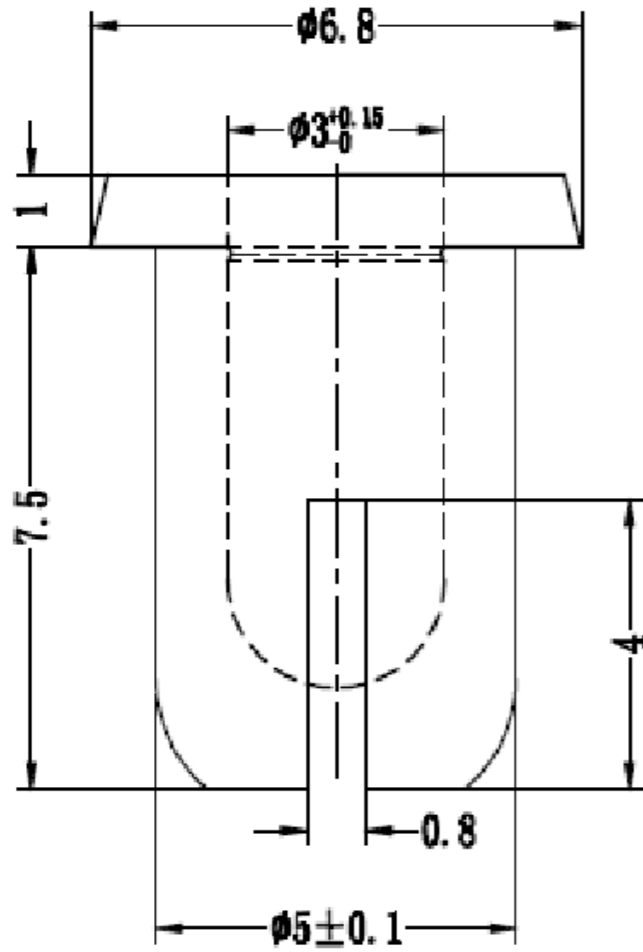

NOTES

Also available in flame retardant nylon (PA6 UL94V-0)



DESIGN RIGHT. TR FASTENINGS LTD, 2003
UNDER NO CIRCUMSTANCES MUST THIS
DRAWING BE COPIED OR DISCLOSED,
WITHOUT FIRST OBTAINING WRITTEN
AUTHORITY.

UNLESS OTHERWISE SPECIFIED:
DIMENSIONS ARE IN MILLIMETERS.
SURFACE FINISH:
TOLERANCES:
L ≤ 4 = ±0,1 4 < L ≤ 15 = ±0,2
15 < L ≤ 50 = ±0,3 50 < L ≤ 100 = ±0,4

NAME	DATE
DRAWN DANIELE MONTALI	13/06/2013
CHK'D	
APPV'D	

MATERIAL
PA6 UL94V-2
ROHS compliant

HEAT TREATMENT
N/A

FINISH
Black or White

TITLE
Snap Rivet

DWG NO.
TRSR5075

A3