

FFSH2065BDN-F085

Silicon Carbide Schottky Diode, 650 V, 20 A

Description

Silicon Carbide (SiC) Schottky Diodes use a completely new technology that provides superior switching performance and higher reliability compared to Silicon. No reverse recovery current, temperature independent switching characteristics, and excellent thermal performance sets Silicon Carbide as the next generation of power semiconductor. System benefits include highest efficiency, faster operating frequency, increased power density, reduced EMI, and reduced system size & cost.

Features

- Max Junction Temperature 175°C
- Avalanche Rated 49 mJ
- High Surge Current Capacity
- Positive Temperature Coefficient
- Ease of Paralleling
- No Reverse Recovery/No Forward Recovery
- AEC-Q101 Qualified
- These Devices are Pb-Free, Halogen Free/BFR Free and are RoHS Compliant

Applications

- Automotive HEV-EV Onboard Chargers
- Automotive HEV-EV DC-DC Converters



ON Semiconductor®

www.onsemi.com

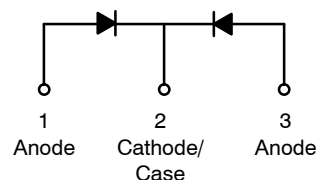

Schottky Diode

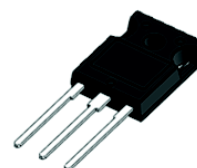

TO-247-3LD
CASE 340CH

MARKING DIAGRAM



\$Y	= ON Semiconductor Logo
&Z	= Assembly Plant Code
&3	= Numeric Date Code
&K	= Lot Code
FFSH2065BDN	= Specific Device Code

ORDERING INFORMATION

See detailed ordering and shipping information on page 2 of this data sheet.

FFSH2065BDN-F085

ABSOLUTE MAXIMUM RATINGS ($T_C = 25^\circ\text{C}$ unless otherwise noted)

Symbol	Parameter	Value	Unit	
V_{RRM}	Peak Repetitive Reverse Voltage	650	V	
E_{AS}	Single Pulse Avalanche Energy (Note 1)	49*/49**	mJ	
I_F	Continuous Rectified Forward Current @ $T_C < 136^\circ\text{C}$	10*/20**	A	
$I_{F, Max}$	Non-Repetitive Peak Forward Surge Current	$T_C = 25^\circ\text{C}, 10 \mu\text{s}$	650	A
		$T_C = 150^\circ\text{C}, 10 \mu\text{s}$	570	A
$I_{F, SM}$	Non-Repetitive Forward Surge Current $T_C = 25^\circ\text{C}$	Half-Sine Pulse, $t_p = 8.3 \text{ ms}$	42	A
P_{tot}	Power Dissipation	$T_C = 25^\circ\text{C}$	65	W
		$T_C = 150^\circ\text{C}$	22	W
T_J, T_{STG}	Operating and Storage Temperature Range	-55 to +175	$^\circ\text{C}$	
	TO247 Mounting Torque, M3 Screw	60	Ncm	

Stresses exceeding those listed in the Maximum Ratings table may damage the device. If any of these limits are exceeded, device functionality should not be assumed, damage may occur and reliability may be affected.

* Per Leg, ** Per Device

1. E_{AS} of 49 mJ is based on starting $T_J = 25^\circ\text{C}$, $L = 0.5 \text{ mH}$, $I_{AS} = 14 \text{ A}$, $V = 50 \text{ V}$.

THERMAL CHARACTERISTICS

Symbol	Parameter	Value	Unit
$R_{\theta JC}$	Thermal Resistance, Junction to Case, Max	2.3*/1.2**	$^\circ\text{C}/\text{W}$

* Per Leg, ** Per Device

ELECTRICAL CHARACTERISTICS ($T_C = 25^\circ\text{C}$ unless otherwise noted (per leg))

Symbol	Parameter	Test Condition	Min	Typ	Max	Unit
V_F	Forward Voltage	$I_F = 10 \text{ A}, T_C = 25^\circ\text{C}$	-	1.38	1.7	V
		$I_F = 10 \text{ A}, T_C = 125^\circ\text{C}$	-	1.6	2.0	
		$I_F = 10 \text{ A}, T_C = 175^\circ\text{C}$	-	1.72	2.4	
I_R	Reverse Current	$V_R = 650 \text{ V}, T_C = 25^\circ\text{C}$	-	0.5	40	μA
		$V_R = 650 \text{ V}, T_C = 125^\circ\text{C}$	-	1	80	
		$V_R = 650 \text{ V}, T_C = 175^\circ\text{C}$	-	2	160	
Q_C	Total Capacitive Charge	$V = 400 \text{ V}$	-	25	-	nC
C	Total Capacitance	$V_R = 1 \text{ V}, f = 100 \text{ kHz}$	-	421	-	pF
		$V_R = 300 \text{ V}, f = 100 \text{ kHz}$	-	40	-	
		$V_R = 600 \text{ V}, f = 100 \text{ kHz}$	-	34	-	

Product parametric performance is indicated in the Electrical Characteristics for the listed test conditions, unless otherwise noted. Product performance may not be indicated by the Electrical Characteristics if operated under different conditions.

PACKAGE MARKING AND ORDERING INFORMATION

Part Number	Top Marking	Package	Shipping
FFSH2065BDN-F085	FFSH2065BDN	TO-247-3LD (Pb-Free / Halogen Free)	30 Units / Tube

TYPICAL CHARACTERISTICS

($T_J = 25^\circ\text{C}$ unless otherwise noted (per leg))

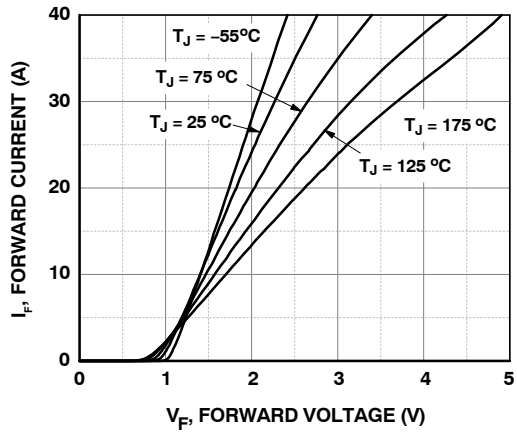

Figure 1. Forward Characteristics

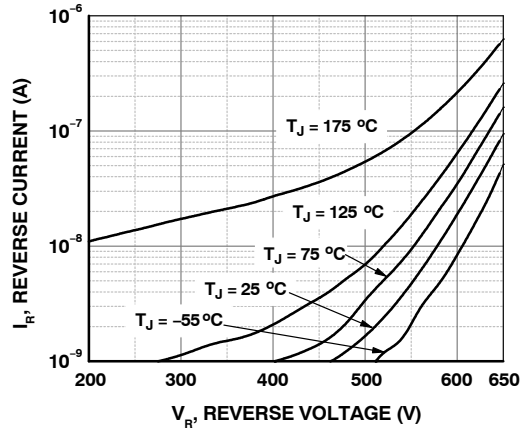

Figure 2. Reverse Characteristics

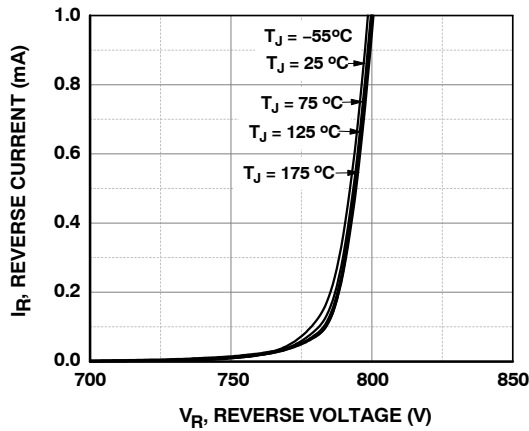

Figure 3. Reverse Characteristics

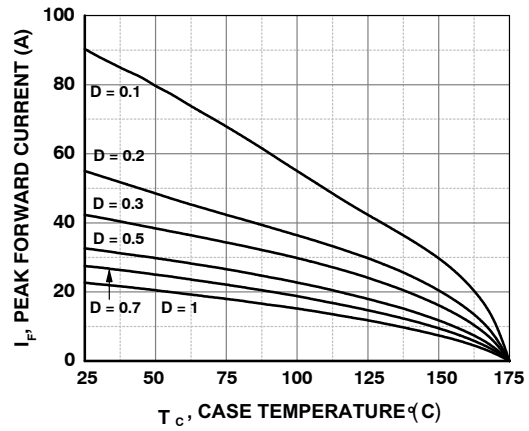

Figure 4. Current Derating

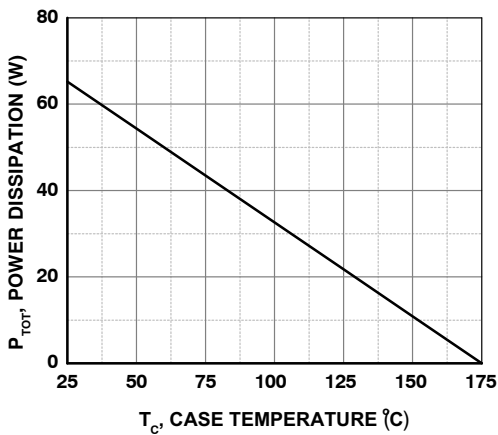

Figure 5. Power Derating

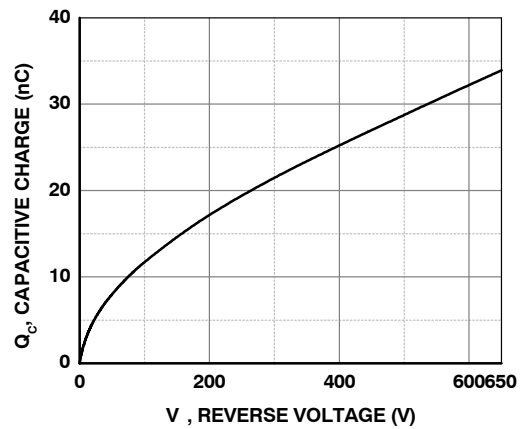

Figure 6. Capacitive Charge vs. Reverse Voltage

TYPICAL CHARACTERISTICS

($T_J = 25^\circ\text{C}$ unless otherwise noted)

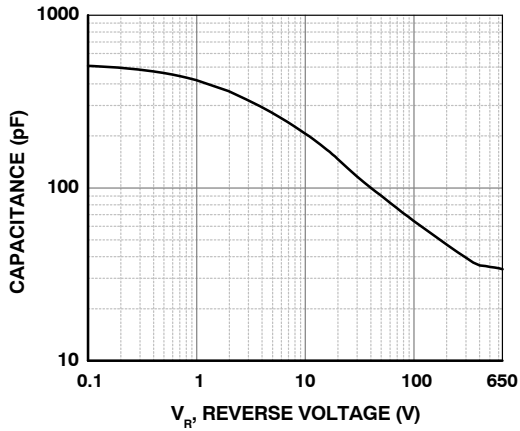

Figure 7. Capacitance vs. Reverse Voltage

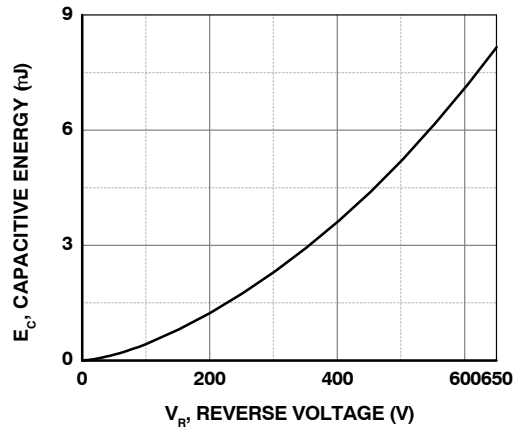

Figure 8. Capacitance Stored Energy

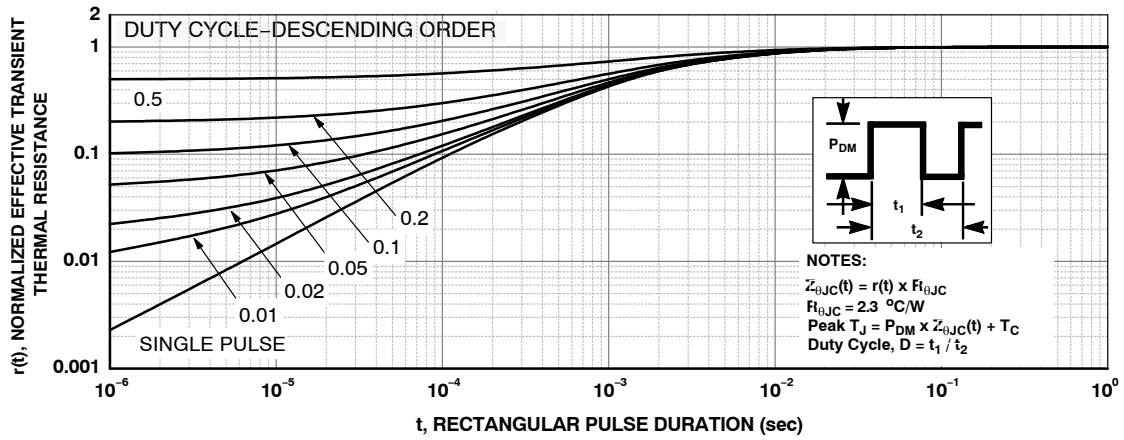

Figure 9. Junction-to-Case Transient Thermal Response Curve

TEST CIRCUIT AND WAVEFORMS

$L = 0.5 \text{ mH}$
 $R < 0.1 \ \Omega$
 $V_{DD} = 50 \text{ V}$
 $E_{AVL} = 1/2LI^2 [V_{R(AVL)} / (V_{R(AVL)} - V_{DD})]$
 $Q1 = \text{IGBT (} BV_{CES} > \text{DUT } V_{R(AVL)} \text{)}$

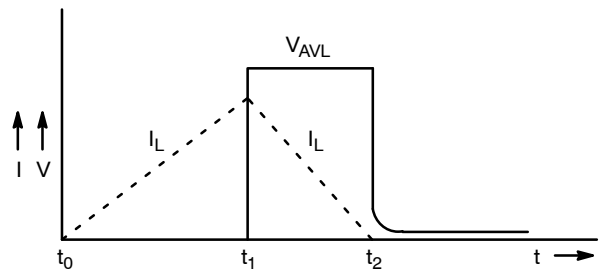
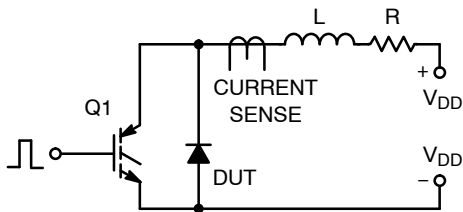

Figure 10. Unclamped Inductive Switching Test Circuit & Waveform

MECHANICAL CASE OUTLINE

PACKAGE DIMENSIONS

TO-247-3LD CASE 340CH ISSUE O

DATE 31 OCT 2016

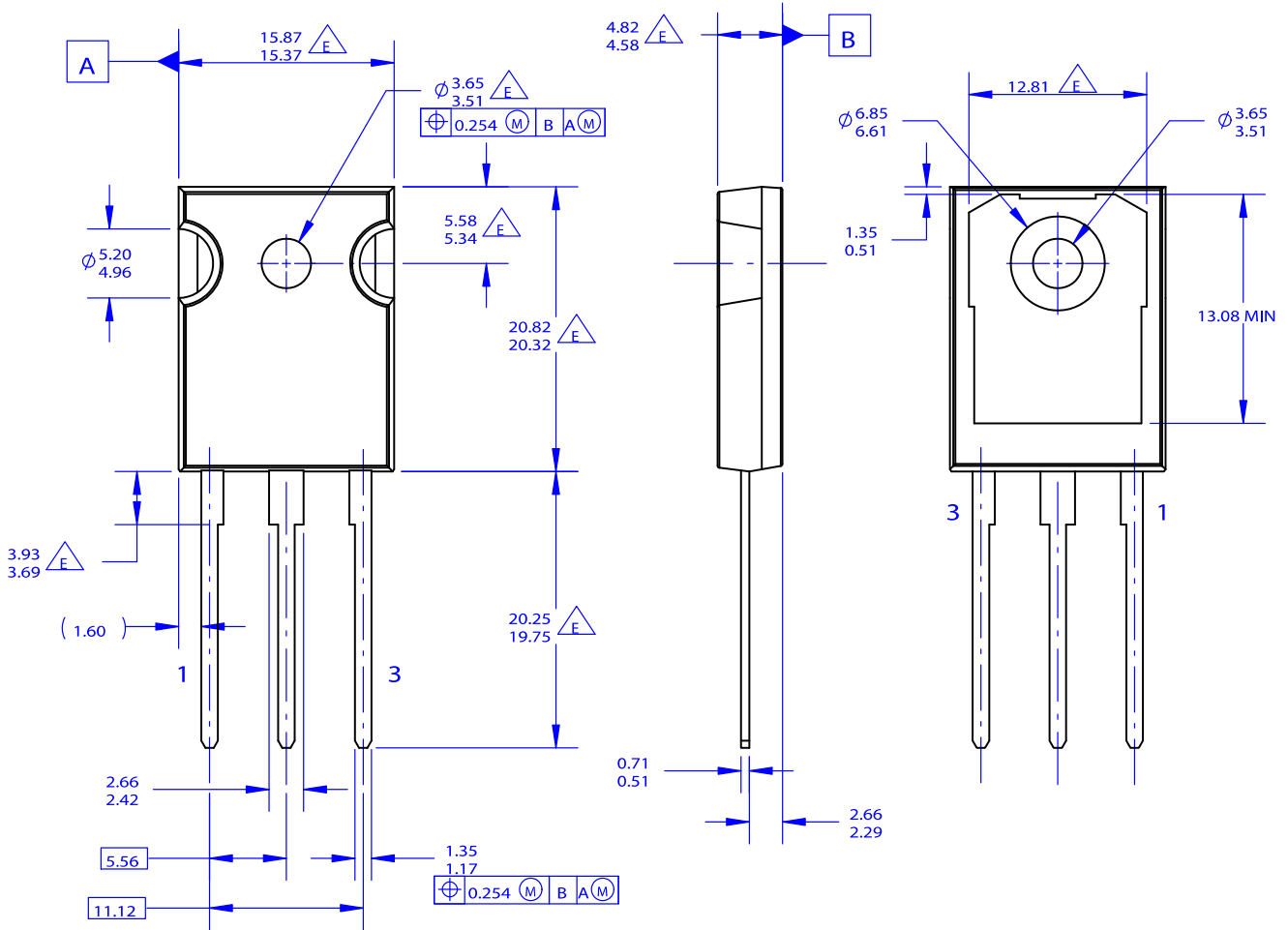

NOTES: UNLESS OTHERWISE SPECIFIED.

- A. PACKAGE REFERENCE: JEDEC TO-247, ISSUE E, VARIATION AB, DATED JUNE, 2004.
- B. DIMENSIONS ARE EXCLUSIVE OF BURRS, MOLD FLASH, AND TIE BAR EXTRUSIONS.
- C. ALL DIMENSIONS ARE IN MILLIMETERS.
- D. DRAWING CONFORMS TO ASME Y14.5 - 1994

 DOES NOT COMPLY JEDEC STANDARD VALUE

DOCUMENT NUMBER:	98AON13853G	Electronic versions are uncontrolled except when accessed directly from the Document Repository. Printed versions are uncontrolled except when stamped "CONTROLLED COPY" in red.
STATUS:	ON SEMICONDUCTOR STANDARD	
NEW STANDARD:		
DESCRIPTION:	TO-247-3LD	PAGE 1 OF 2



ISSUE	REVISION	DATE
O	RELEASED FOR PRODUCTION FROM FAIRCHILD TO247G03 TO ON SEMICONDUCTOR. REQ. BY J. LETTERMAN.	31 OCT 2016

ON Semiconductor and ON are registered trademarks of Semiconductor Components Industries, LLC (SCILLC). SCILLC reserves the right to make changes without further notice to any products herein. SCILLC makes no warranty, representation or guarantee regarding the suitability of its products for any particular purpose, nor does SCILLC assume any liability arising out of the application or use of any product or circuit, and specifically disclaims any and all liability, including without limitation special, consequential or incidental damages. "Typical" parameters which may be provided in SCILLC data sheets and/or specifications can and do vary in different applications and actual performance may vary over time. All operating parameters, including "Typicals" must be validated for each customer application by customer's technical experts. SCILLC does not convey any license under its patent rights nor the rights of others. SCILLC products are not designed, intended, or authorized for use as components in systems intended for surgical implant into the body, or other applications intended to support or sustain life, or for any other application in which the failure of the SCILLC product could create a situation where personal injury or death may occur. Should Buyer purchase or use SCILLC products for any such unintended or unauthorized application, Buyer shall indemnify and hold SCILLC and its officers, employees, subsidiaries, affiliates, and distributors harmless against all claims, costs, damages, and expenses, and reasonable attorney fees arising out of, directly or indirectly, any claim of personal injury or death associated with such unintended or unauthorized use, even if such claim alleges that SCILLC was negligent regarding the design or manufacture of the part. SCILLC is an Equal Opportunity/Affirmative Action Employer. This literature is subject to all applicable copyright laws and is not for resale in any manner.

ON Semiconductor and  are trademarks of Semiconductor Components Industries, LLC dba ON Semiconductor or its subsidiaries in the United States and/or other countries. ON Semiconductor owns the rights to a number of patents, trademarks, copyrights, trade secrets, and other intellectual property. A listing of ON Semiconductor's product/patent coverage may be accessed at www.onsemi.com/site/pdf/Patent-Marking.pdf. ON Semiconductor reserves the right to make changes without further notice to any products herein. ON Semiconductor makes no warranty, representation or guarantee regarding the suitability of its products for any particular purpose, nor does ON Semiconductor assume any liability arising out of the application or use of any product or circuit, and specifically disclaims any and all liability, including without limitation special, consequential or incidental damages. Buyer is responsible for its products and applications using ON Semiconductor products, including compliance with all laws, regulations and safety requirements or standards, regardless of any support or applications information provided by ON Semiconductor. "Typical" parameters which may be provided in ON Semiconductor data sheets and/or specifications can and do vary in different applications and actual performance may vary over time. All operating parameters, including "Typicals" must be validated for each customer application by customer's technical experts. ON Semiconductor does not convey any license under its patent rights nor the rights of others. ON Semiconductor products are not designed, intended, or authorized for use as a critical component in life support systems or any FDA Class 3 medical devices or medical devices with a same or similar classification in a foreign jurisdiction or any devices intended for implantation in the human body. Should Buyer purchase or use ON Semiconductor products for any such unintended or unauthorized application, Buyer shall indemnify and hold ON Semiconductor and its officers, employees, subsidiaries, affiliates, and distributors harmless against all claims, costs, damages, and expenses, and reasonable attorney fees arising out of, directly or indirectly, any claim of personal injury or death associated with such unintended or unauthorized use, even if such claim alleges that ON Semiconductor was negligent regarding the design or manufacture of the part. ON Semiconductor is an Equal Opportunity/Affirmative Action Employer. This literature is subject to all applicable copyright laws and is not for resale in any manner.

PUBLICATION ORDERING INFORMATION

LITERATURE FULFILLMENT:

Literature Distribution Center for ON Semiconductor
19521 E. 32nd Pkwy, Aurora, Colorado 80011 USA
Phone: 303-675-2175 or 800-344-3860 Toll Free USA/Canada
Fax: 303-675-2176 or 800-344-3867 Toll Free USA/Canada
Email: orderlit@onsemi.com

N. American Technical Support: 800-282-9855 Toll Free
USA/Canada
Europe, Middle East and Africa Technical Support:
Phone: 421 33 790 2910

ON Semiconductor Website: www.onsemi.com

Order Literature: <http://www.onsemi.com/orderlit>

For additional information, please contact your local
Sales Representative