

Click [here](#) for production status of specific part numbers.

## MAX40242

## 20V, Low Input Bias-Current, Low-Noise, Dual Op Amp

### General Description

The MAX40242 provides a combination of high voltage, low noise, low input bias current in a dual channel and features rail-to-rail at the output.

This dual amplifier operates over a wide supply voltage range from a single 2.7V to 20V supply or split  $\pm 1.35V$  to  $\pm 10V$  supplies and consumes only 1.2mA quiescent supply current per channel.

The MAX40242 is a unity-gain stable amplifier with a gain-bandwidth product of 10MHz. The device outputs drive up to 200pF load capacitor without any external isolation resistor compensation.

The MAX40242 is available in 8-thin wafer-level packages (WLPs) and is rated for operation over the  $-40^{\circ}C$  to  $+125^{\circ}C$  automotive temperature range.

### Applications

- Chemical Sensor Interface
- Photodiode Sensor Interface
- Medical Pulse Oximetry
- Industrial: Process and Control
- Precision Instrumentation

### Benefits and Features

- 2.7V to 20V Single Supply or  $\pm 1.35V$  to  $\pm 10V$  Dual Supplies
- 2pA (Max) Input Bias Current
- $5nV/\sqrt{Hz}$  Input Voltage Noise
- 10MHz Bandwidth
- $8V/\mu s$  Slew Rate
- Rail-to-Rail Output
- Integrated EMI Filters
- 1.2mA Supply Current per Amplifier
- Tiny, 0.85mm x 1.65mm 8-WLP

Ordering Information appears at end of data sheet.

### Typical Application Circuit

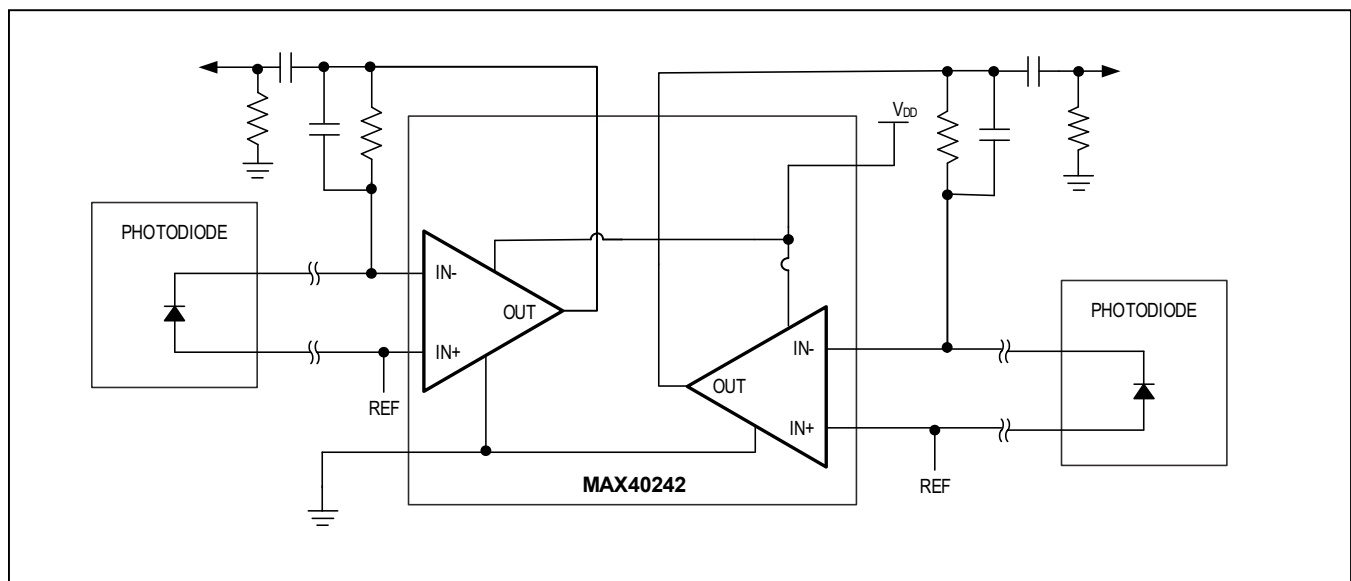

### Absolute Maximum Ratings

Supply Voltage ( $V_{DD}$ to $V_{SS}$ )	-0.3V to +22V	Operating Temperature Range	-40°C to +125°C
All Other Pins	( $V_{SS} - 0.3V$ ) to ( $V_{DD} + 0.3V$ )	Junction Temperature	+150°C
Short-Circuit Duration to $V_{DD}$ or $V_{SS}$	1s	Storage Temperature Range	-65°C to +150°C
Continuous Input Current (Any Pins)	±20mA	Lead Temperature (soldering, 10s)	+300°C
Differential Input Voltage	±6V		
Continuous Power Dissipation ( $T_A = +70^\circ\text{C}$ )			
8-THIN WLP (derate 11.4mW/°C above +70°C)	912mW		

Stresses beyond those listed under "Absolute Maximum Ratings" may cause permanent damage to the device. These are stress ratings only, and functional operation of the device at these or any other conditions beyond those indicated in the operational sections of the specifications is not implied. Exposure to absolute maximum rating conditions for extended periods may affect device reliability.

### Package Thermal Characteristics (Note 1)

8-THIN WLP

Junction-to-Ambient Thermal Resistance ( $\theta_{JA}$ )	87.71°C/W
Junction-to-Case Thermal Resistance ( $\theta_{JC}$ )	NA°C/W

**Note 1:** Package thermal resistances were obtained using the method described in JEDEC specification JESD51-7, using a four-layer board. For detailed information on package thermal considerations, refer to [www.maximintegrated.com/thermal-tutorial](http://www.maximintegrated.com/thermal-tutorial).

### Electrical Characteristics

( $V_{DD} = 10V$ ,  $V_{SS} = 0V$ ,  $V_{IN+} = V_{IN-} = V_{DD}/2$ ,  $R_L = 10k\Omega$  to  $V_{DD}/2$ ,  $T_A = -40^\circ\text{C}$  to  $+125^\circ\text{C}$ , unless otherwise noted. Typical values are at  $T_A = +25^\circ\text{C}$ .) (Note 2)

PARAMETER	SYMBOL	CONDITIONS	MIN	TYP	MAX	UNITS
<b>POWER SUPPLY</b>						
Supply Voltage Range	$V_{DD}$	Guaranteed by PSRR	2.7		20	V
Power-Supply Rejection Ratio	PSRR	$V_{DD} = 2.7V$ to $20V$ , $V_{CM} = 0V$	$T_A = +25^\circ\text{C}$	106	130	dB
			$-40^\circ\text{C} \leq T_A \leq +125^\circ\text{C}$	100		
Quiescent Current Per Amplifier	$I_{DD}$	$R_{LOAD} = \text{infinity}$	$T_A = +25^\circ\text{C}$	1.2	1.6	mA
			$-40^\circ\text{C} \leq T_A \leq +125^\circ\text{C}$		1.8	
Power-Up Time	$t_{ON}$	$R_{LOAD} = 10k\Omega$ to $V_{DD}/2$ , $C_{LOAD} = 20pF$ , $V_{OUT}$ reaches $V_{DD}/2$ to 1%		20		$\mu\text{s}$
<b>DC CHARACTERISTICS</b>						
Input Common-Mode Range	$V_{CM}$	Guaranteed by CMRR test	$V_{SS} - 0.05$		$V_{DD} - 1.5$	V
Common-Mode Rejection Ratio	CMRR	$V_{CM} = V_{SS} - 0.05V$ to $V_{DD} - 1.5V$	$T_A = +25^\circ\text{C}$	94	111	dB
			$-40^\circ\text{C} \leq T_A \leq +125^\circ\text{C}$	90		
Input Offset Voltage	$V_{OS}$	$T_A = +25^\circ\text{C}$		50	600	$\mu\text{V}$
		$-40^\circ\text{C} \leq T_A \leq +125^\circ\text{C}$			800	
Input Offset Voltage Drift (Note 3)	$TC V_{OS}$			0.25	2.5	$\mu\text{V}/^\circ\text{C}$
Input Bias Current (Note 3)	$I_B$	$T_A = +25^\circ\text{C}$		0.02	2	pA
		$-40^\circ\text{C} \leq T_A \leq +85^\circ\text{C}$			15	
		$-40^\circ\text{C} \leq T_A \leq +125^\circ\text{C}$			75	

## Electrical Characteristics (continued)

( $V_{DD} = 10V$ ,  $V_{SS} = 0V$ ,  $V_{IN+} = V_{IN-} = V_{DD}/2$ ,  $R_L = 10k\Omega$  to  $V_{DD}/2$ ,  $T_A = -40^\circ C$  to  $+125^\circ C$ , unless otherwise noted. Typical values are at  $T_A = +25^\circ C$ .) (Note 2)

PARAMETER	SYMBOL	CONDITIONS	MIN	TYP	MAX	UNITS
Input Offset Current (Note 3)	$I_{OS}$	$T_A = +25^\circ C$		0.04	1	pA
		$-40^\circ C \leq T_A \leq +85^\circ C$			10	
		$-40^\circ C \leq T_A \leq +125^\circ C$				
Open Loop Gain	$A_{VOL}$	$250mV \leq V_{OUT} \leq V_{DD} - 250mV$	$T_A = +25^\circ C$	134	145	dB
			$-40^\circ C \leq T_A \leq +125^\circ C$	129		
Input Resistance	$R_{IN}$	Differential		50		M $\Omega$
		Common mode		200		
Output Short-Circuit Current (Note 3)		To $V_{DD}$ or $V_{SS}$   Noncontinuous (1s)		95		mA
Output Voltage Low	$V_{OL}$	$V_{OUT} - V_{SS}$ , $R_{LOAD} = 10k\Omega$ to $V_{DD}/2$ , $T_A = +25^\circ C$		11	15	mV
		$V_{OUT} - V_{SS}$ , $R_{LOAD} = 10k\Omega$ to $V_{DD}/2$ , $-40^\circ C < T_A < 125^\circ C$			25	
		$V_{OUT} - V_{SS}$ , $R_{LOAD} = 2k\Omega$ to $V_{DD}/2$ , $T_A = +25^\circ C$		47	60	
		$V_{OUT} - V_{SS}$ , $R_{LOAD} = 2k\Omega$ to $V_{DD}/2$ , $-40^\circ C < T_A < 125^\circ C$			85	
Output Voltage High	$V_{OH}$	$V_{OUT} - V_{SS}$ , $R_{LOAD} = 10k\Omega$ to $V_{DD}/2$ , $T_A = +25^\circ C$		20	26	mV
		$V_{OUT} - V_{SS}$ , $R_{LOAD} = 10k\Omega$ to $V_{DD}/2$ , $-40^\circ C < T_A < 125^\circ C$			37	
		$V_{OUT} - V_{SS}$ , $R_{LOAD} = 2k\Omega$ to $V_{DD}/2$ , $T_A = +25^\circ C$		80	100	
		$V_{OUT} - V_{SS}$ , $R_{LOAD} = 2k\Omega$ to $V_{DD}/2$ , $-40^\circ C < T_A < 125^\circ C$			135	
<b>AC CHARACTERISTICS</b>						
Input Voltage-Noise Density	$e_n$	$f = 1kHz$		5		nV/ $\sqrt{Hz}$
Input Voltage Noise		$0.1Hz \leq f \leq 10Hz$		1.6		$\mu V_{P-P}$
Input Current-Noise Density	$I_N$	$f = 1kHz$		0.3		pA/ $\sqrt{Hz}$
Input Capacitance	$C_{IN}$			4		pF
Gain-Bandwidth Product	GBW			10		MHz
Phase Margin	PM	$C_{LOAD} = 20pF$		60		°
Slew Rate	SR	$A_V = 1V/V$ , $V_{OUT} = 2V_{P-P}$ , 10% to 90%		8		V/ $\mu s$
Large-Signal Bandwidth	BW	$R_{LOAD} = 10k\Omega$ to $V_{DD}/2$ , $C_{LOAD} = 20pF$ , $A_V = 1V/V$		1		MHz
Capacitive Loading	$C_{LOAD}$	No sustained oscillation, $A_V = 1V/V$		200		pF
Crosstalk	$X_T$	$R_{LOAD} = 2k\Omega$ to $V_{DD}/2$ , $C_{LOAD} = 20pF$ , $V_{OUT} = 5V_{P-P}$ , $f = 100kHz$		-98		dB

**Electrical Characteristics (continued)**

( $V_{DD} = 10V$ ,  $V_{SS} = 0V$ ,  $V_{IN+} = V_{IN-} = V_{DD}/2$ ,  $R_L = 10k\Omega$  to  $V_{DD}/2$ ,  $T_A = -40^\circ C$  to  $+125^\circ C$ , unless otherwise noted. Typical values are at  $T_A = +25^\circ C$ .) (Note 2)

PARAMETER	SYMBOL	CONDITIONS		MIN	TYP	MAX	UNITS
Total Harmonic Distortion Plus Noise	THD+N	$V_{OUT} = 2V_{P-P}$ , $A_V = +1V/V$	f = 1kHz		-124		dB
			f = 20kHz		-100		
EMI Rejection Ratio	EMIRR	$V_{RF\_PEAK} = 100mV$	f = 400MHz		35		dB
			f = 800MHz		40		
			f = 1800MHz		50		
			f = 2400MHz		57		
Settling Time		To 0.1%, $V_{OUT} = 2V$ step, $A_V = -1V/V$			2		$\mu s$

**Note 2:** All devices are production tested at  $T_A = +25^\circ C$ . Specifications over temperature are guaranteed by design.

**Note 3:** Guaranteed by design.

Typical Operating Characteristics

( $V_{DD} = 10V$ ,  $V_{SS} = 0V$ , outputs have  $R_L = 10k\Omega$  to  $V_{DD}/2$ .  $T_A = +25^\circ C$ , unless otherwise specified.)

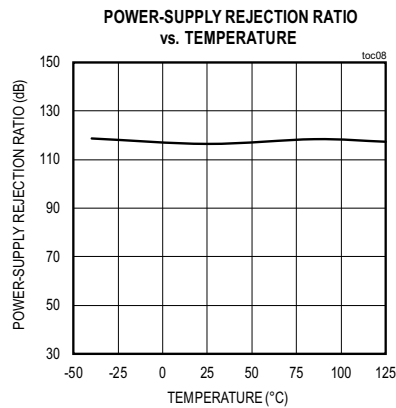
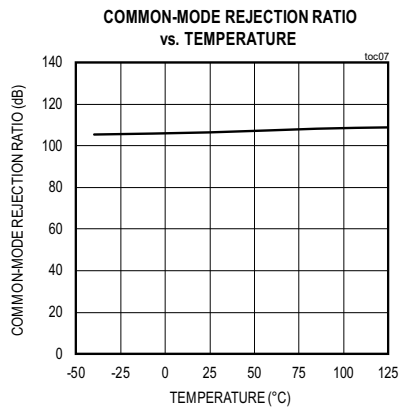
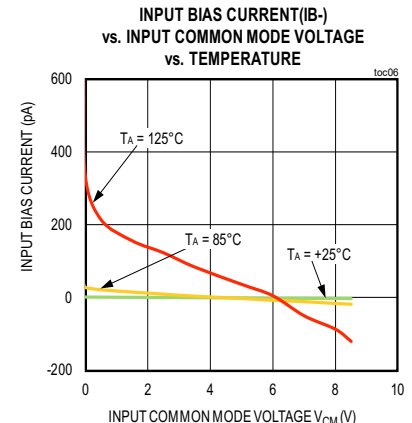
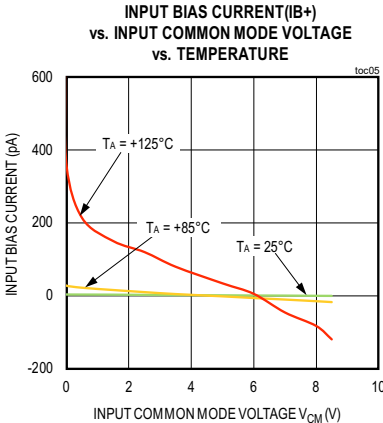
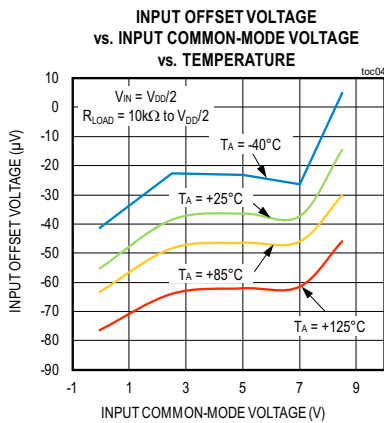
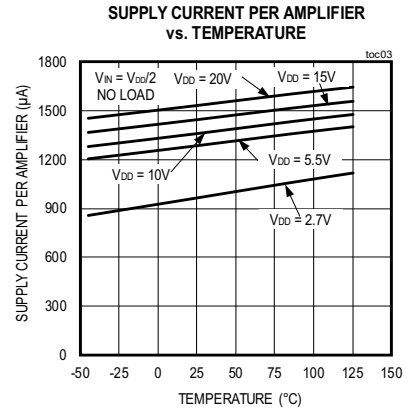
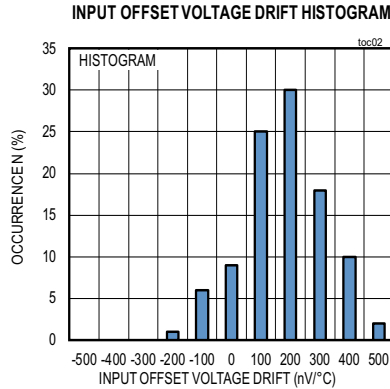
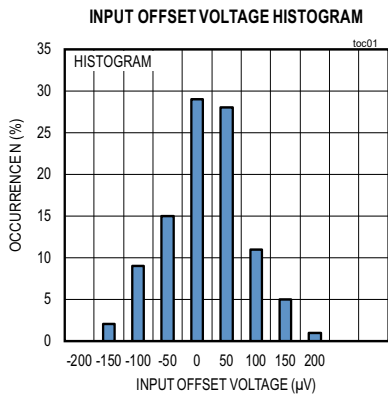

Typical Operating Characteristics (continued)

( $V_{DD} = 10V$ ,  $V_{SS} = 0V$ , outputs have  $R_L = 10k\Omega$  to  $V_{DD}/2$ .  $T_A = +25^\circ C$ , unless otherwise specified.)

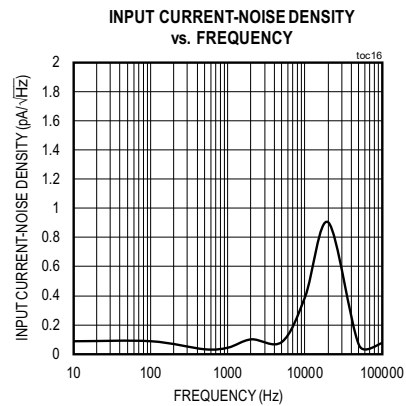
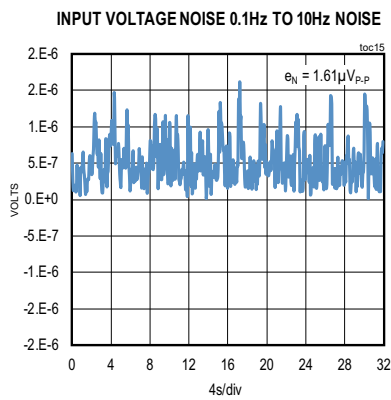
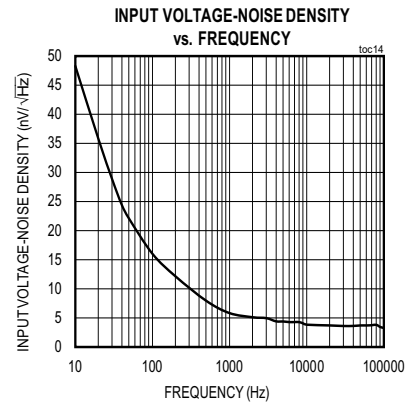
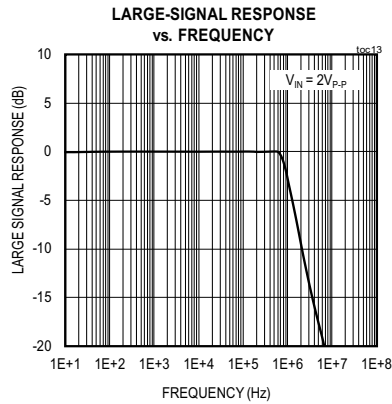
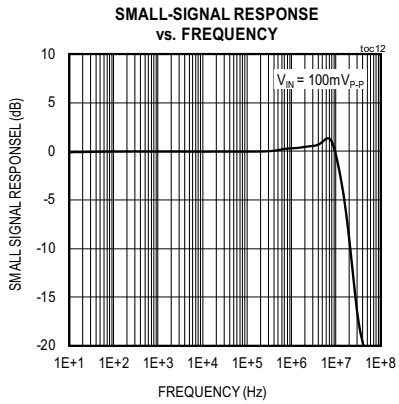
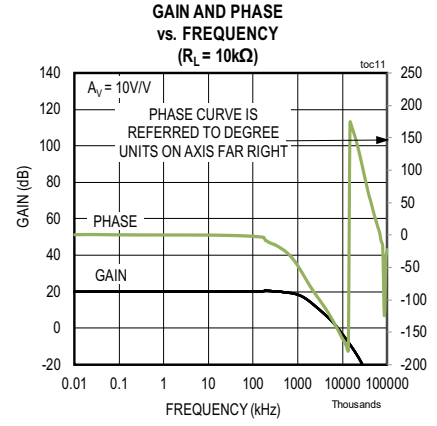
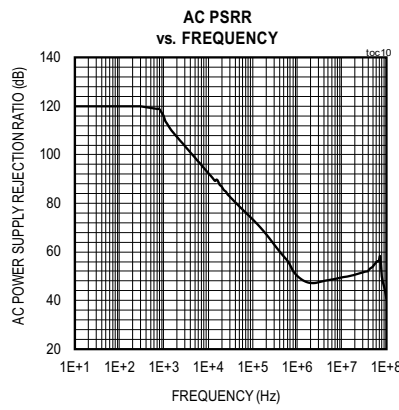
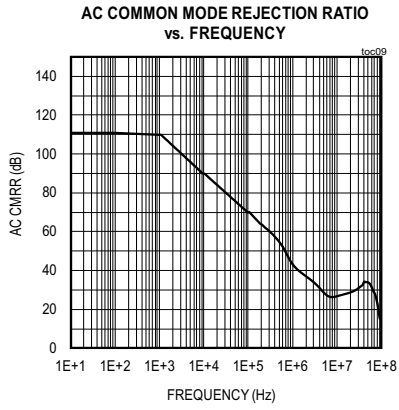

Typical Operating Characteristics (continued)

( $V_{DD} = 10V$ ,  $V_{SS} = 0V$ , outputs have  $R_L = 10k\Omega$  to  $V_{DD}/2$ .  $T_A = +25^\circ C$ , unless otherwise specified.)

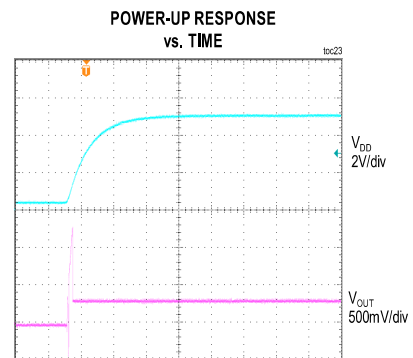
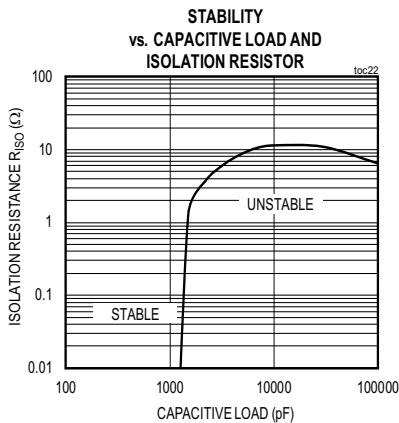
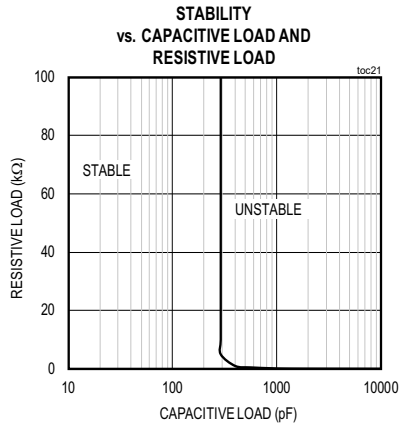
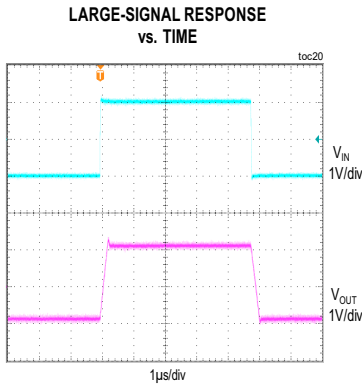
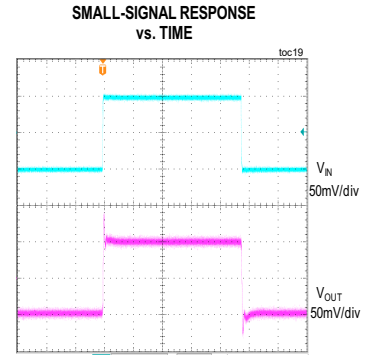
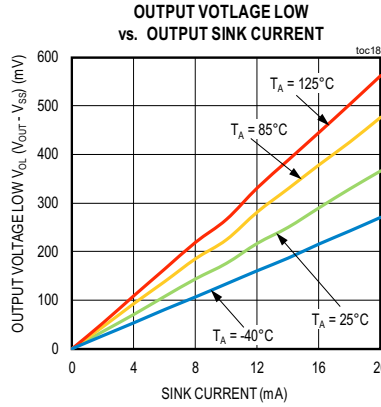
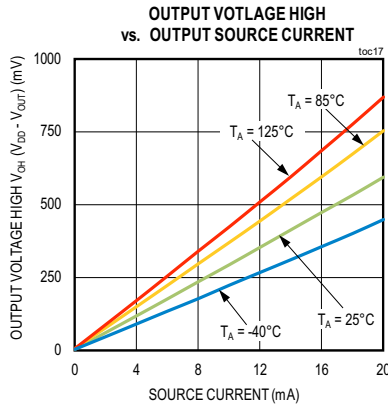

Typical Operating Characteristics (continued)

( $V_{DD} = 10V$ ,  $V_{SS} = 0V$ , outputs have  $R_L = 10k\Omega$  to  $V_{DD}/2$ .  $T_A = +25^\circ C$ , unless otherwise specified.)

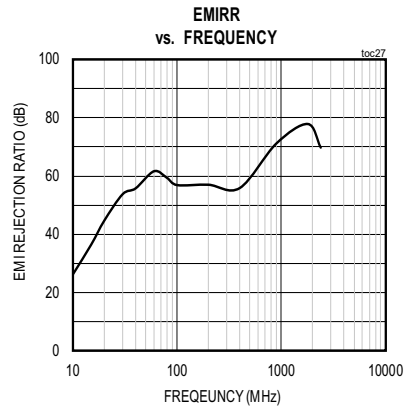
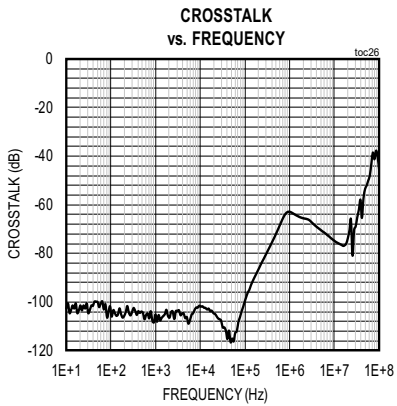
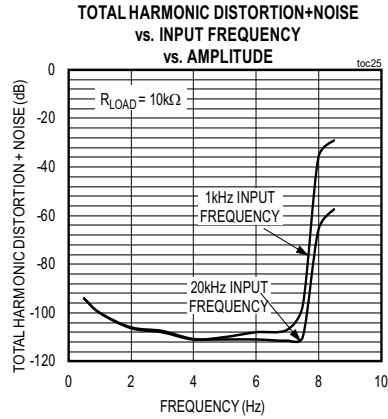
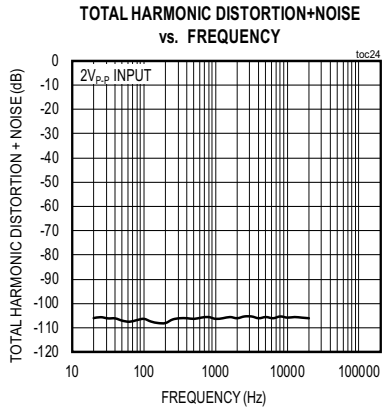



**Pin Configuration**

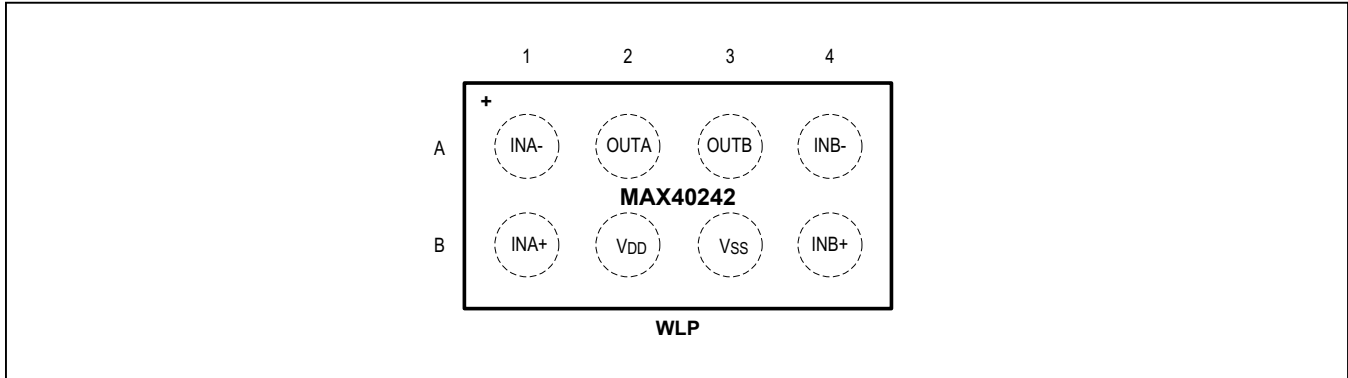

**Bump Description**

BUMP (WLP)	NAME	FUNCTION
A1	INA-	Channel A Negative Input
A2	OUTA	Channel A Output
A3	OUTB	Channel B Output
A4	INB-	Channel B Negative Input
B1	INA+	Channel A Positive Input
B2	V <sub>DD</sub>	Positive Supply Voltage
B3	V <sub>SS</sub>	Negative Supply Voltage. Connect V <sub>SS</sub> to ground if single supply is used.
B4	INB+	Channel B Positive Input

**Detailed Description**

Combining high input impedance, low input bias current, wide bandwidth, and fast settling time, the MAX40242 is an ideal amplifier for driving precision analog-to-digital inputs and buffering digital-to-analog converter outputs.

**Input Bias Current**

The MAX40242 features a high-impedance CMOS input stage and a special ESD structure that allows low input bias current operation at low-input, common-mode voltages. Low input bias current is useful when interfacing with high-ohmic or capacitive sensors and is beneficial for designing transimpedance amplifiers for photodiode sensors. This makes the device ideal for ground-referenced medical and industrial sensor applications.

**Integrated EMI Filter**

Electromagnetic interference (EMI) noise occurs at higher frequency that results in malfunction or degradation of electrical equipment.

The MAX40242 has an input EMI filter to avoid the output from getting affected by radio frequency interference. The EMI filter, composed of passive devices, presents significant higher impedance to higher frequencies.

**High Supply Voltage Range**

The device features 1.2mA current consumption per channel and a voltage supply range from either 2.7V to 20V single supply or ±1.35V to ±10V split supply.

## Typical Application Circuit

### High-Impedance Sensor Application

High impedance sources like pH sensor, photodiodes in applications require negligible input leakage currents to the input transimpedance/buffer structure. The MAX40242 benefits with clean and precise signal conditioning due to its input structure.

The device interfaces to both current-output sensors (photodiodes) (Figure 1), and high-impedance voltage sources (piezoelectric sensors). For current output sensors, a transimpedance amplifier is the most noise-efficient method for converting the input signal to a voltage. High-value feedback resistors are commonly chosen to create large gains, while feedback capacitors help stabilize the amplifier by cancelling any poles introduced in the feedback loop by the highly capacitive sensor or cabling. A combination of low-current noise and low-voltage noise is important for these applications. Take care to calibrate out photodiode dark current if DC accuracy is important. The high bandwidth and slew rate also allow AC signal processing in certain medical photodiode sensor applications such as pulse-oximetry. For voltage-output sensors, a noninverting amplifier is typically used to buffer and/or apply a small gain to the

input voltage signal. Due to the extremely high impedance of the sensor output, a low input bias current with minimal temperature variation is very important for these applications.

### Transimpedance Amplifier

As shown in Figure 1, the noninverting pin is biased at 2V with C2 added to bypass high-frequency noise. This bias voltage to reverse biases the photodiode D1 at 2V which is often enough to minimize the capacitance across the junction. Hence, the reverse current ( $I_R$ ) produced by the photodiode as light photons are incident on it, a proportional voltage is produced at the output of the amplifier by the given relation:

$$V_{OUT} = I_R \times R1$$

The addition of C1 is to compensate for the instability caused due to the additional capacitance at the input (junction capacitance  $C_j$  and input capacitance of the op amp  $C_{IN}$ ), which results in loss of phase margin. More information about stabilizing the transimpedance amplifier can be found in [Application Note 5129: Stabilize Your Transimpedance Amplifier](#).

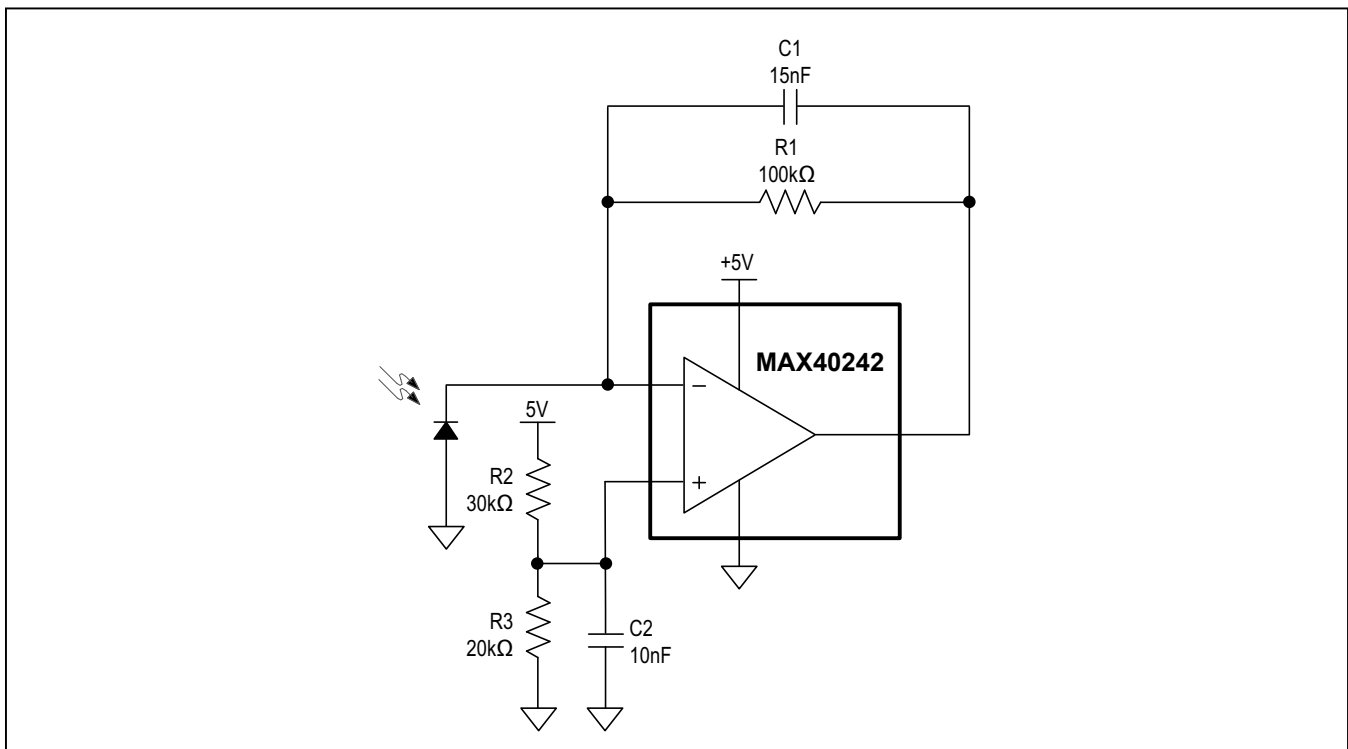

Figure 1. High-Impedance Source/Sensor Preamp Application

MAX40242

20V, Low Input Bias-Current,  
Low-Noise, Dual Op Amp

### Ordering Information

PART	TEMP RANGE	PIN-PACKAGE	TOP MARK
MAX40242ANA+	-40°C to +125°C	8-THIN WLP	+AAN

+Denotes lead(Pb)-free/RoHS-compliant package.

### Chip Information

PROCESS: BiCMOS

### Package Information

For the latest package outline information and land patterns (footprints), go to [www.maximintegrated.com/packages](http://www.maximintegrated.com/packages). Note that a "+", "#", or "-" in the package code indicates RoHS status only. Package drawings may show a different suffix character, but the drawing pertains to the package regardless of RoHS status.

PACKAGE TYPE	PACKAGE CODE	OUTLINE NO.	LAND PATTERN NO.
8-THIN WLP	N80D1+1	<a href="#">21-100280</a>	<a href="#">Apps Note 1891</a>

MAX40242

20V, Low Input Bias-Current,  
Low-Noise, Dual Op Amp

### Revision History

REVISION NUMBER	REVISION DATE	DESCRIPTION	PAGES CHANGED
0	6/18	Initial release	—

For pricing, delivery, and ordering information, please contact Maxim Direct at 1-888-629-4642, or visit Maxim Integrated's website at [www.maximintegrated.com](http://www.maximintegrated.com).

*Maxim Integrated cannot assume responsibility for use of any circuitry other than circuitry entirely embodied in a Maxim Integrated product. No circuit patent licenses are implied. Maxim Integrated reserves the right to change the circuitry and specifications without notice at any time. The parametric values (min and max limits) shown in the Electrical Characteristics table are guaranteed. Other parametric values quoted in this data sheet are provided for guidance.*