



ON Semiconductor®

## FGD3245G2-F085 / FGB3245G2-F085

### EcoSPARK® 2 320mJ, 450V, N-Channel Ignition IGBT

#### Features

- SCIS Energy = 320mJ at  $T_J = 25^\circ\text{C}$
- Logic Level Gate Drive
- Low Saturation Voltage
- Qualified to AEC Q101
- RoHS Compliant

#### Applications

- Automotive Ignition Coil Driver Circuits
- Coil On Plug Applications

#### General Description

The FGB3245G2-F085 and FGD3245G2 are N-channel IGBTs designed in ON Semiconductor's EcoSPARK-2 technology which helps in eliminating external protection circuitry. The technology is optimized for driving the coil in the harsh environment of automotive ignition systems and offers out-standing  $V_{sat}$  and SCIS Energy capability also at elevated operating temperatures. The logic level gate input is ESD protected and features an integrated gate resistor. An integrated zener-circuitry clamps the IGBT's collector-to-emitter voltage at 450V which enables systems requiring a higher spark voltage



FGD3245G2-F085 / FGB3245G2-F085

#### Package

#### Symbol

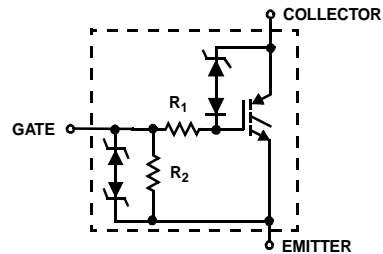
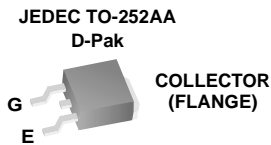
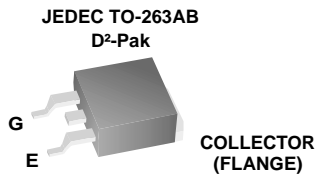

**Device Maximum Ratings**  $T_A = 25^\circ\text{C}$  unless otherwise noted

Symbol	Parameter	Rating	Units
$BV_{CER}$	Collector to Emitter Breakdown Voltage ( $I_C = 1\text{mA}$ )	450	V
$BV_{ECS}$	Emitter to Collector Voltage - Reverse Battery Condition ( $I_C = 10\text{mA}$ )	28	V
$E_{SCIS25}$	Self Clamping Inductive Switching Energy (Note 1)	320	mJ
$E_{SCIS150}$	Self Clamping Inductive Switching Energy (Note 2)	180	mJ
$I_{C25}$	Collector Current Continuous, at $V_{GE} = 4.0\text{V}$ , $T_C = 25^\circ\text{C}$	23	A
$I_{C110}$	Collector Current Continuous, at $V_{GE} = 4.0\text{V}$ , $T_C = 110^\circ\text{C}$	23	A
$V_{GEM}$	Gate to Emitter Voltage Continuous	$\pm 10$	V
$P_D$	Power Dissipation Total, at $T_C = 25^\circ\text{C}$	150	W
	Power Dissipation Derating, for $T_C > 25^\circ\text{C}$	1.1	W/ $^\circ\text{C}$
$T_J$	Operating Junction Temperature Range	-40 to +175	$^\circ\text{C}$
$T_{STG}$	Storage Junction Temperature Range	-40 to +175	$^\circ\text{C}$
$T_L$	Max. Lead Temp. for Soldering (Leads at 1.6mm from case for 10s)	300	$^\circ\text{C}$
$T_{PKG}$	Max. Lead Temp. for Soldering (Package Body for 10s)	260	$^\circ\text{C}$
ESD	Electrostatic Discharge Voltage at 100pF, 1500 $\Omega$	4	kV
	CDM-Electrostatic Discharge Voltage at 1 $\Omega$	2	kV

**Package Marking and Ordering Information**

Device Marking	Device	Package	Reel Size	Tape Width	Quantity
FGD3245G2	FGD3245G2-F085	TO252AA	330mm	16mm	2500 units
FGB3245G2	FGB3245G2-F085	TO263AB	330mm	24mm	800 units

**Electrical Characteristics**  $T_A = 25^\circ\text{C}$  unless otherwise noted

Symbol	Parameter	Test Conditions	Min	Typ	Max	Units
--------	-----------	-----------------	-----	-----	-----	-------

**Off State Characteristics**

$BV_{CER}$	Collector to Emitter Breakdown Voltage	$I_{CE} = 2\text{mA}$ , $V_{GE} = 0$ , $R_{GE} = 1\text{K}\Omega$ , $T_J = -40$ to $150^\circ\text{C}$	420	-	480	V	
$BV_{CES}$	Collector to Emitter Breakdown Voltage	$I_{CE} = 10\text{mA}$ , $V_{GE} = 0\text{V}$ , $R_{GE} = 0$ , $T_J = -40$ to $150^\circ\text{C}$	440	-	500	V	
$BV_{ECS}$	Emitter to Collector Breakdown Voltage	$I_{CE} = -75\text{mA}$ , $V_{GE} = 0\text{V}$ , $T_J = 25^\circ\text{C}$	28	-	-	V	
$BV_{GES}$	Gate to Emitter Breakdown Voltage	$I_{GES} = \pm 2\text{mA}$	$\pm 12$	$\pm 14$	-	V	
$I_{CER}$	Collector to Emitter Leakage Current	$V_{CE} = 250\text{V}$ , $R_{GE} = 1\text{K}\Omega$	$T_J = 25^\circ\text{C}$	-	-	25	$\mu\text{A}$
			$T_J = 150^\circ\text{C}$	-	-	1	mA
$I_{ECS}$	Emitter to Collector Leakage Current	$V_{EC} = 24\text{V}$	$T_J = 25^\circ\text{C}$	-	-	1	mA
			$T_J = 150^\circ\text{C}$	-	-	40	
$R_1$	Series Gate Resistance		-	120	-	$\Omega$	
$R_2$	Gate to Emitter Resistance		10K	-	30K	$\Omega$	

**On State Characteristics**

$V_{CE(SAT)}$	Collector to Emitter Saturation Voltage	$I_{CE} = 6\text{A}$ , $V_{GE} = 4\text{V}$ ,	$T_J = 25^\circ\text{C}$	-	1.13	1.25	V
$V_{CE(SAT)}$	Collector to Emitter Saturation Voltage	$I_{CE} = 10\text{A}$ , $V_{GE} = 4.5\text{V}$ ,	$T_J = 150^\circ\text{C}$	-	1.32	1.50	V
$V_{CE(SAT)}$	Collector to Emitter Saturation Voltage	$I_{CE} = 15\text{A}$ , $V_{GE} = 4.5\text{V}$ ,	$T_J = 150^\circ\text{C}$	-	1.64	1.85	V

**Electrical Characteristics**  $T_A = 25^\circ\text{C}$  unless otherwise noted

Symbol	Parameter	Test Conditions	Min	Typ	Max	Units
--------	-----------	-----------------	-----	-----	-----	-------

**Dynamic Characteristics**

$Q_{G(ON)}$	Gate Charge	$I_{CE} = 10\text{A}, V_{CE} = 12\text{V}, V_{GE} = 5\text{V}$	-	23	-	nC
$V_{GE(TH)}$	Gate to Emitter Threshold Voltage	$I_{CE} = 1\text{mA}, V_{CE} = V_{GE}, T_J = 25^\circ\text{C}$	1.3	1.6	2.2	V
		$T_J = 150^\circ\text{C}$	0.75	1.1	1.8	
$V_{GEP}$	Gate to Emitter Plateau Voltage	$V_{CE} = 12\text{V}, I_{CE} = 10\text{A}$	-	2.7	-	V

**Switching Characteristics**

$t_{d(ON)R}$	Current Turn-On Delay Time-Resistive	$V_{CE} = 14\text{V}, R_L = 1\Omega$	-	0.9	4	$\mu\text{s}$
$t_{rR}$	Current Rise Time-Resistive	$V_{GE} = 5\text{V}, R_G = 1\text{K}\Omega, T_J = 25^\circ\text{C}$	-	2.6	7	$\mu\text{s}$
$t_{d(OFF)L}$	Current Turn-Off Delay Time-Inductive	$V_{CE} = 300\text{V}, L = 1\text{mH}$	-	5.4	15	$\mu\text{s}$
$t_{fL}$	Current Fall Time-Inductive	$V_{GE} = 5\text{V}, R_G = 1\text{K}\Omega, I_{CE} = 6.5\text{A}, T_J = 25^\circ\text{C}$	-	2.7	15	$\mu\text{s}$
$E_{SCIS}$	Self Clamped Inductive Switching	$L = 3.0\text{mHy}, R_G = 1\text{K}\Omega, V_{GE} = 5\text{V}, (Note 1), T_J = 25^\circ\text{C}$	-	-	320	mJ

**Thermal Characteristics**

$R_{\theta JC}$	Thermal Resistance Junction to Case	All packages	-	-	0.9	$^\circ\text{C/W}$
-----------------	-------------------------------------	--------------	---	---	-----	--------------------

**Notes:**

1: Self Clamping Inductive Switching Energy ( $E_{SCIS25}$ ) of 320 mJ is based on the test conditions that starting  $T_J = 25^\circ\text{C}$ ;  $L = 3\text{mHy}$ ,  $I_{SCIS} = 14.6\text{A}$ ,  $V_{CC} = 100\text{V}$  during inductor charging and  $V_{CC} = 0\text{V}$  during the time in clamp.

2: Self Clamping Inductive Switching Energy ( $E_{SCIS150}$ ) of 180 mJ is based on the test conditions that starting  $T_J = 150^\circ\text{C}$ ;  $L = 3\text{mHy}$ ,  $I_{SCIS} = 10.9\text{A}$ ,  $V_{CC} = 100\text{V}$  during inductor charging and  $V_{CC} = 0\text{V}$  during the time in clamp.

## Typical Performance Curves

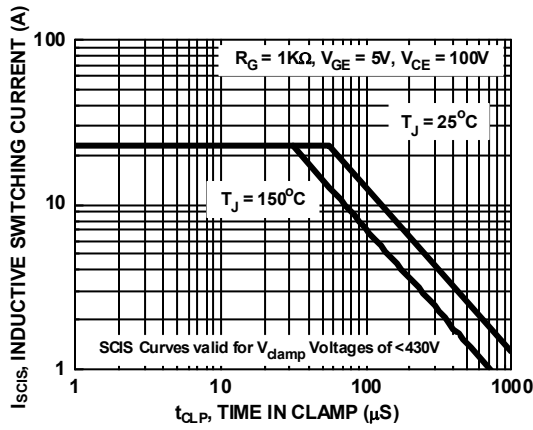

Figure 1. Self Clamped Inductive Switching Current vs. Time in Clamp

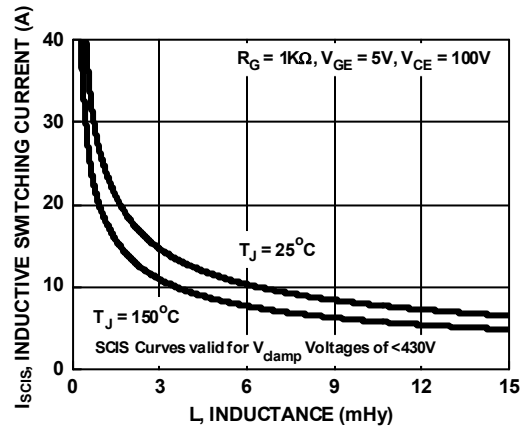

Figure 2. Self Clamped Inductive Switching Current vs. Inductance

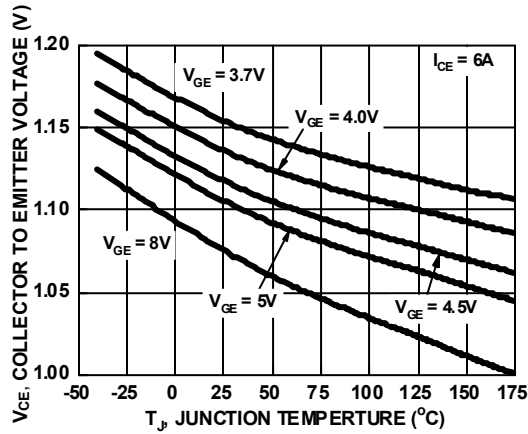

Figure 3. Collector to Emitter On-State Voltage vs. Junction Temperature

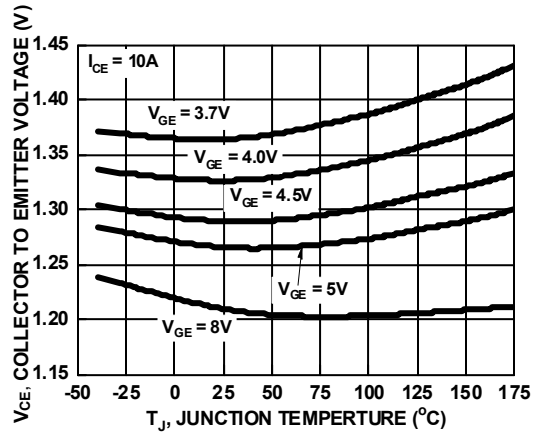

Figure 4. Collector to Emitter On-State Voltage vs. Junction Temperature

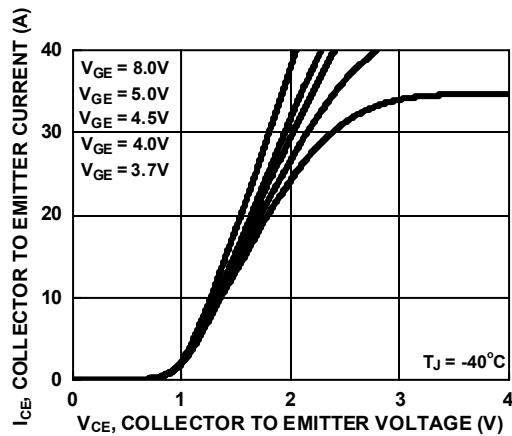

Figure 5. Collector to Emitter On-State Voltage vs. Collector Current

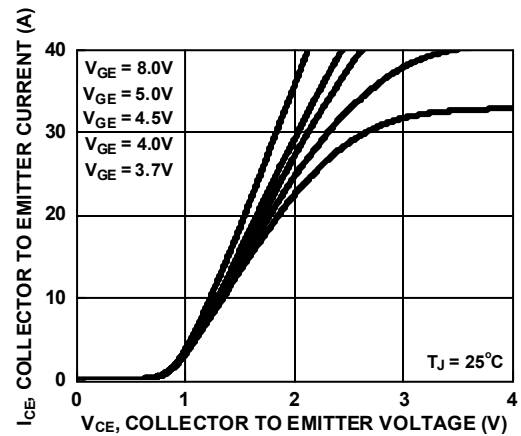

Figure 6. Collector to Emitter On-State Voltage vs. Collector Current

Typical Performance Curves (Continued)

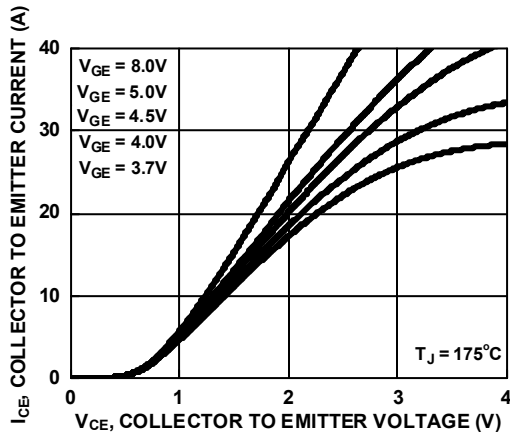

Figure 7. Collector to Emitter On-State Voltage vs. Collector Current

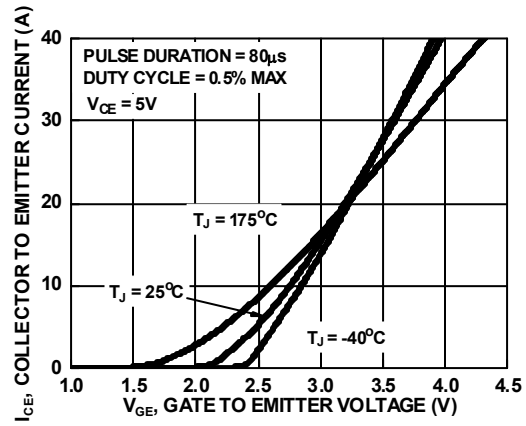

Figure 8. Transfer Characteristics

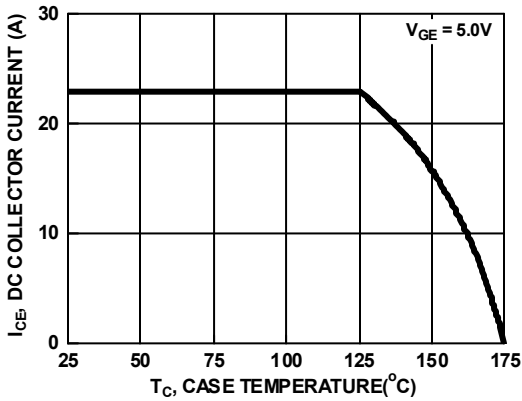

Figure 9. DC Collector Current vs. Case Temperature

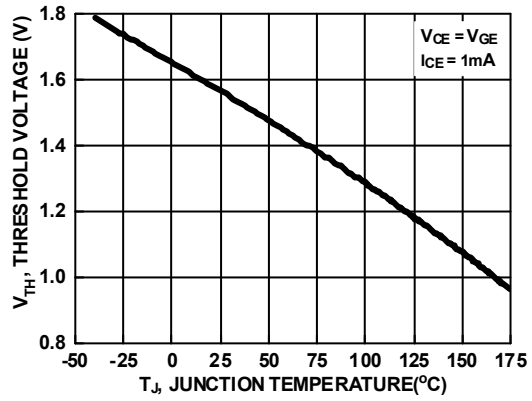

Figure 10. Threshold Voltage vs. Junction Temperature

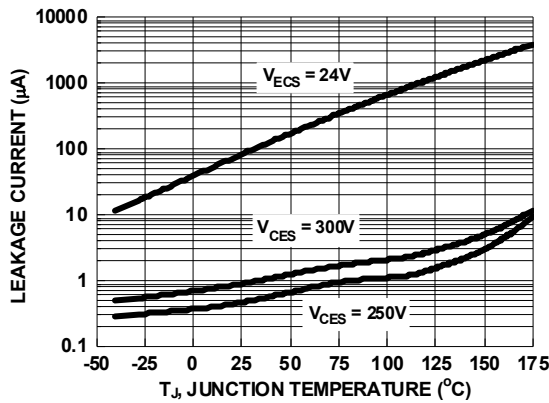

Figure 11. Leakage Current vs. Junction Temperature

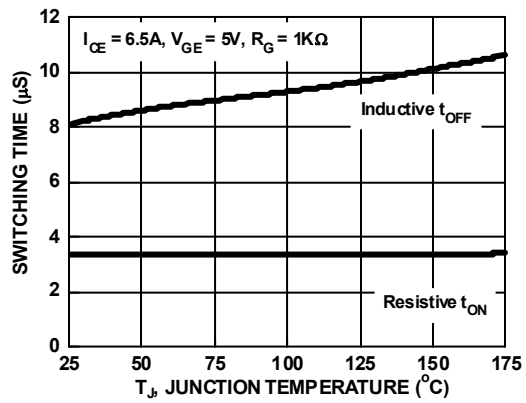
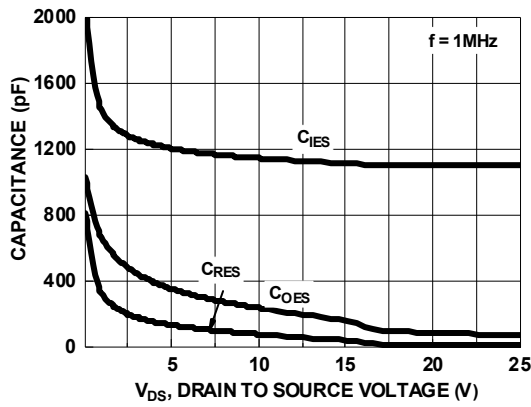
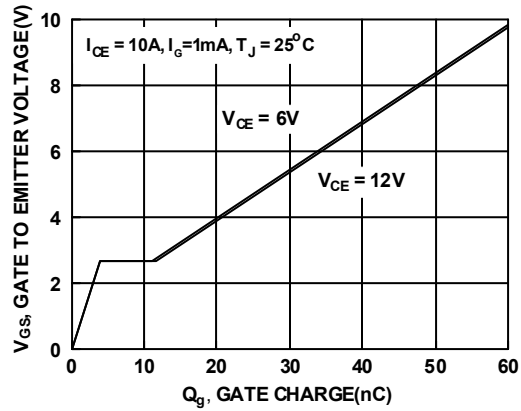

Figure 12. Switching Time vs. Junction Temperature

**Typical Performance Curves** (Continued)



**Figure 13. Capacitance vs. Collector to Emitter Voltage**



**Figure 14. Gate Charge**

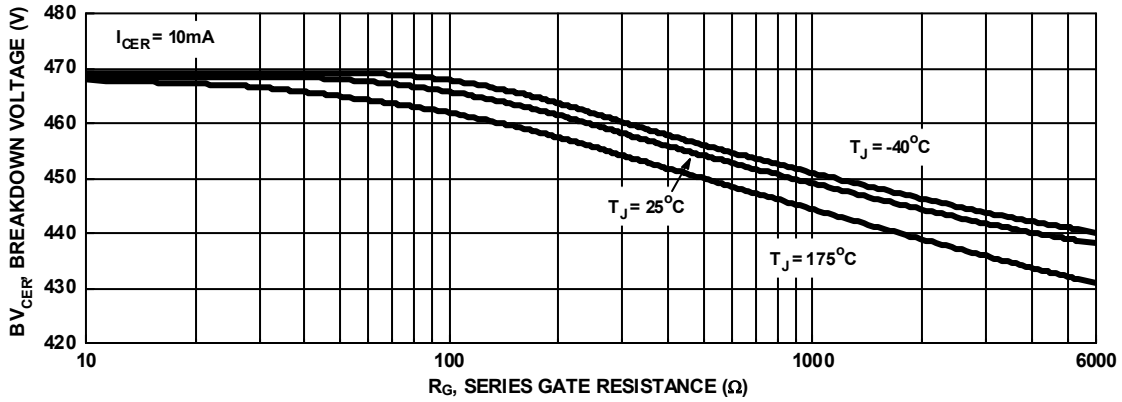

**Figure 15. Break down Voltage vs. Series Gate Resistance**

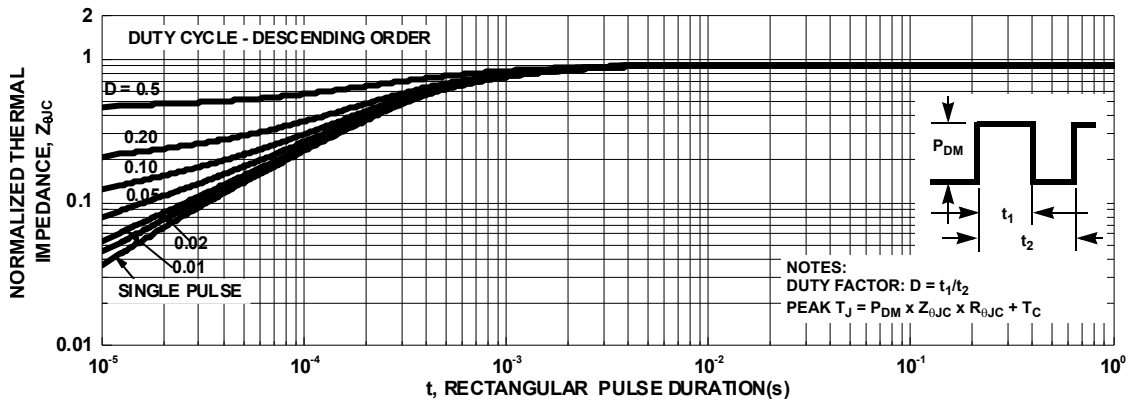

**Figure 16. IGBT Normalized Transient Thermal Impedance, Junction to Case**

## Test Circuit and Waveforms

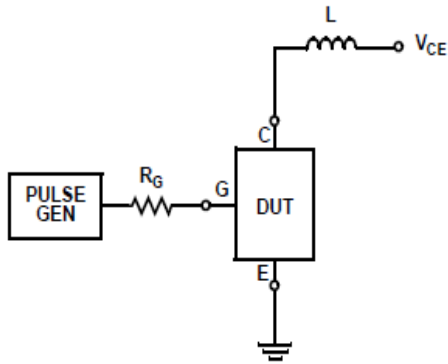

Figure 17. Inductive Switching Test Circuit

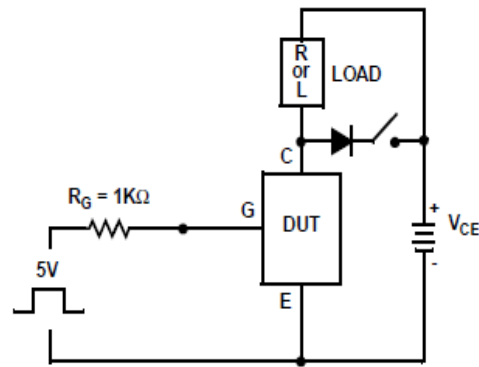

Figure 18.  $t_{ON}$  and  $t_{OFF}$  Switching Test Circuit

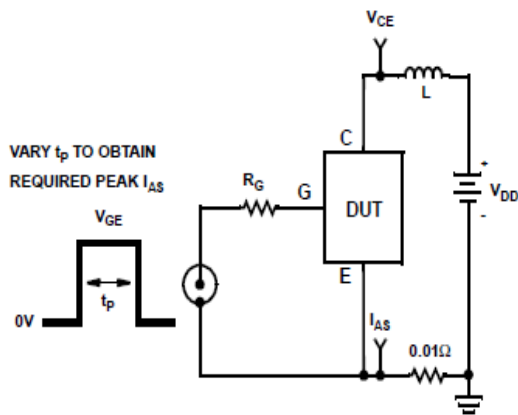

Figure 19. Energy Test Circuit

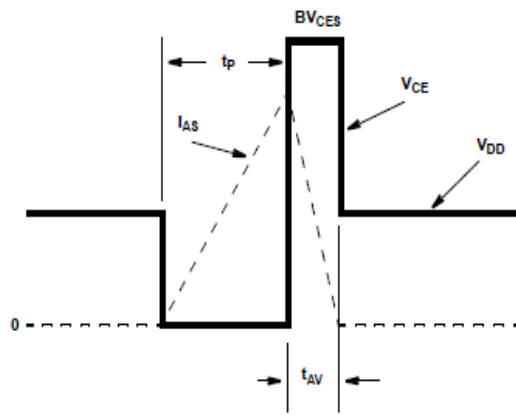



Figure 20. Energy Waveforms

ON Semiconductor and  are trademarks of Semiconductor Components Industries, LLC dba ON Semiconductor or its subsidiaries in the United States and/or other countries. ON Semiconductor owns the rights to a number of patents, trademarks, copyrights, trade secrets, and other intellectual property. A listing of ON Semiconductor's product/patent coverage may be accessed at [www.onsemi.com/site/pdf/Patent-Marking.pdf](http://www.onsemi.com/site/pdf/Patent-Marking.pdf). ON Semiconductor reserves the right to make changes without further notice to any products herein. ON Semiconductor makes no warranty, representation or guarantee regarding the suitability of its products for any particular purpose, nor does ON Semiconductor assume any liability arising out of the application or use of any product or circuit, and specifically disclaims any and all liability, including without limitation special, consequential or incidental damages. Buyer is responsible for its products and applications using ON Semiconductor products, including compliance with all laws, regulations and safety requirements or standards, regardless of any support or applications information provided by ON Semiconductor. "Typical" parameters which may be provided in ON Semiconductor data sheets and/or specifications can and do vary in different applications and actual performance may vary over time. All operating parameters, including "Typicals" must be validated for each customer application by customer's technical experts. ON Semiconductor does not convey any license under its patent rights nor the rights of others. ON Semiconductor products are not designed, intended, or authorized for use as a critical component in life support systems or any FDA Class 3 medical devices or medical devices with a same or similar classification in a foreign jurisdiction or any devices intended for implantation in the human body. Should Buyer purchase or use ON Semiconductor products for any such unintended or unauthorized application, Buyer shall indemnify and hold ON Semiconductor and its officers, employees, subsidiaries, affiliates, and distributors harmless against all claims, costs, damages, and expenses, and reasonable attorney fees arising out of, directly or indirectly, any claim of personal injury or death associated with such unintended or unauthorized use, even if such claim alleges that ON Semiconductor was negligent regarding the design or manufacture of the part. ON Semiconductor is an Equal Opportunity/Affirmative Action Employer. This literature is subject to all applicable copyright laws and is not for resale in any manner.

## PUBLICATION ORDERING INFORMATION

### LITERATURE FULFILLMENT:

Literature Distribution Center for ON Semiconductor  
19521 E. 32nd Pkwy, Aurora, Colorado 80011 USA  
**Phone:** 303-675-2175 or 800-344-3860 Toll Free USA/Canada  
**Fax:** 303-675-2176 or 800-344-3867 Toll Free USA/Canada  
**Email:** [orderlit@onsemi.com](mailto:orderlit@onsemi.com)

**N. American Technical Support:** 800-282-9855 Toll Free  
USA/Canada  
**Europe, Middle East and Africa Technical Support:**  
Phone: 421 33 790 2910  
**Japan Customer Focus Center**  
Phone: 81-3-5817-1050

**ON Semiconductor Website:** [www.onsemi.com](http://www.onsemi.com)

**Order Literature:** <http://www.onsemi.com/orderlit>

For additional information, please contact your local Sales Representative