

# F93-AJ6 Series



## Resin-Molded Chip - Automotive Product Range



### FEATURES

- Compliant to the RoHS2 directive 2011/65/EU
- Compliant to AEC-Q200

### APPLICATIONS

- Cabin electronics
- Infotainment



### CASE DIMENSIONS: millimeters (inches)

Code	EIA Code	EIA Metric	L	W <sub>1</sub>	W <sub>2</sub>	H	S
A	1206	3216-18	3.20 ± 0.20 (0.126 ± 0.008)	1.60 ± 0.20 (0.063 ± 0.008)	1.20 ± 0.10 (0.047 ± 0.004)	1.60 ± 0.20 (0.063 ± 0.008)	0.80 ± 0.20 (0.031 ± 0.008)
B	1210	3528-21	3.50 ± 0.20 (0.126 ± 0.008)	2.80 ± 0.20 (0.110 ± 0.008)	2.20 ± 0.10 (0.087 ± 0.004)	1.90 ± 0.20 (0.075 ± 0.008)	0.80 ± 0.20 (0.031 ± 0.008)
C	2312	6032-27	6.00 ± 0.20 (0.236 ± 0.008)	3.20 ± 0.20 (0.126 ± 0.008)	2.20 ± 0.10 (0.087 ± 0.004)	2.50 ± 0.20 (0.098 ± 0.008)	1.30 ± 0.20 (0.051 ± 0.008)
N	2917	7343-30	7.30 ± 0.20 (0.287 ± 0.008)	4.30 ± 0.20 (0.169 ± 0.008)	2.40 ± 0.10 (0.094 ± 0.004)	2.80 ± 0.20 (0.110 ± 0.008)	1.30 ± 0.20 (0.051 ± 0.008)

#### A, B CASE

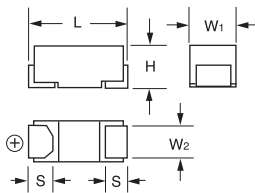

#### C, N CASE

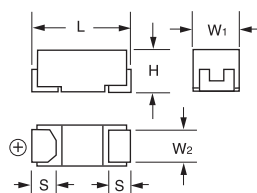

### MARKING

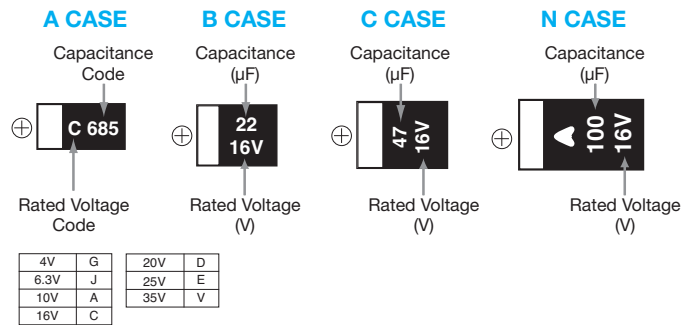

### HOW TO ORDER

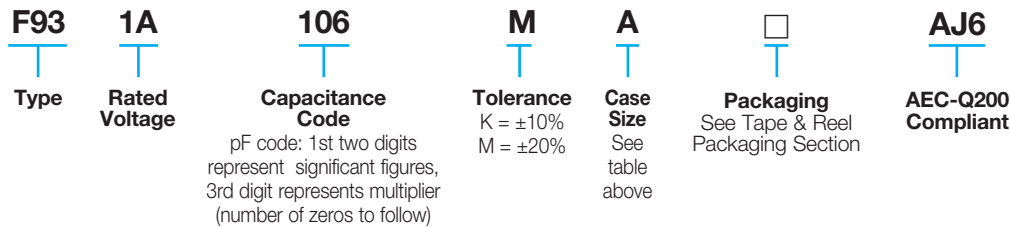

### TECHNICAL SPECIFICATIONS

Category Temperature Range:	-55 to +125°C
Rated Temperature:	+85°C
Capacitance Tolerance:	±20%, ±10% at 120Hz
Dissipation Factor:	Refer to next page
ESR 100kHz:	Refer to next page
Leakage Current:	After 1 minute's application of rated voltage, leakage current at 20°C is not more than 0.01CV or 0.5µA, whichever is greater. After 1 minute's application of rated voltage, leakage current at 85°C is not more than 0.1CV or 5µA, whichever is greater. After 1 minute's application of derated voltage, leakage current at 125°C is not more than 0.125CV or 6.3µA, whichever is greater.
Capacitance Change By Temperature	+15% Max. at +125°C +10% Max. at +85°C -10% Max. at -55°C

# F93-AJ6 Series



## Resin-Molded Chip - Automotive Product Range

### CAPACITANCE AND RATED VOLTAGE RANGE (LETTER DENOTES CASE SIZE)

Capacitance		Rated Voltage						
μF	Code	4V (0G)	6.3V (0J)	10V (1A)	16V (1C)	20V (1D)	25V (1E)	35V (1V)
1.0	105				A		A	A
1.5	155				A		A	A
2.2	225				A	A	A	A/B
3.3	335				A	A	A	B
4.7	475			A	A	A/B	A/B	B/C
6.8	685			A	A	A/B		C
10	106		A	A	A/B	A/B	B/C	C
15	156		A	A	A/B	C	C	N
22	226	A	A	A/B	A/B/C	B/C	C/N	N
33	336	A	A	A/B	B/C	C/N	N	N
47	476	A	A/B	A/B/C	B <sup>M</sup> /C/N	C/N	N	
68	686	A	A/B	B/C	C/N			
100	107	A/B	A/B/C	C/N	C/N			
150	157	B	B/C	C/N	N			
220	227	B/C	C/N	N				
330	337	C	N	N				
470	477	N	N					
680	687	N						

Released ratings (M tolerance only)

# F93-AJ6 Series



## Resin-Molded Chip - Automotive Product Range

### RATINGS & PART NUMBER REFERENCE

AVX Part No.	Case Size	Capacitance (µF)	Rated Voltage (V)	DCL (µA)	DF @ 120Hz (%)	ESR @ 100kHz (Ω)	*1 ΔC/C (%)	MSL
<b>4 Volt</b>								
F930G226#AAAJ6	A	22	4	0.9	6	2.5	*	3
F930G336#AAAJ6	A	33	4	1.3	8	2.5	*	3
F930G476#AAAJ6	A	47	4	1.9	18	2.5	*	3
F930G686#AAAJ6	A	68	4	2.7	24	2.5	*	3
F930G107#AAAJ6	A	100	4	4	30	2.0	*	3
F930G107#BAAJ6	B	100	4	4	14	0.9	*	3
F930G157#BAAJ6	B	150	4	6	16	0.7	*	3
F930G227#BAAJ6	B	220	4	8.8	18	0.7	*	3
F930G227#CCAJ6	C	220	4	8.8	12	0.7	*	3
F930G337#CCAJ6	C	330	4	13.2	14	0.7	*	3
F930G477#NCAJ6	N	470	4	18.8	16	0.3	*	3
F930G687#NCAJ6	N	680	4	27.2	18	0.3	*	3
<b>6.3 Volt</b>								
F930J106#AAAJ6	A	10	6.3	0.6	6	3.0	*	3
F930J156#AAAJ6	A	15	6.3	0.9	6	2.9	*	3
F930J226#AAAJ6	A	22	6.3	1.4	8	2.5	*	3
F930J336#AAAJ6	A	33	6.3	2.1	8	2.5	*	3
F930J476#AAAJ6	A	47	6.3	3	18	2.5	*	3
F930J476#BAAJ6	B	47	6.3	3	6	1.0	*	3
F930J686#AAAJ6	A	68	6.3	4.3	20	2.0	*	3
F930J686#BAAJ6	B	68	6.3	4.3	8	1.0	*	3
F930J107#AAAJ6	A	100	6.3	6.3	35	2.0	±15	3
F930J107#BAAJ6	B	100	6.3	6.3	14	0.9	*	3
F930J107#CCAJ6	C	100	6.3	6.3	8	0.7	*	3
F930J157#BAAJ6	B	150	6.3	9.5	18	0.9	*	3
F930J157#CCAJ6	C	150	6.3	9.5	12	0.7	*	3
F930J227#CCAJ6	C	220	6.3	13.9	14	0.7	*	3
F930J227#NCAJ6	N	220	6.3	13.9	10	0.5	*	3
F930J337#NCAJ6	N	330	6.3	20.8	14	0.5	*	3
F930J477#NCAJ6	N	470	6.3	29.6	16	0.3	*	3
<b>10 Volt</b>								
F931A475#AAAJ6	A	4.7	10	0.5	6	4.0	*	3
F931A685#AAAJ6	A	6.8	10	0.7	6	3.5	*	3
F931A106#AAAJ6	A	10	10	1	6	3.0	*	3
F931A156#AAAJ6	A	15	10	1.5	8	2.9	*	3
F931A226#AAAJ6	A	22	10	2.2	12	2.5	*	3
F931A226#BAAJ6	B	22	10	2.2	6	1.9	*	3
F931A336#AAAJ6	A	33	10	3.3	18	2.5	*	3
F931A336#BAAJ6	B	33	10	3.3	8	1.4	*	3
F931A476#AAAJ6	A	47	10	4.7	40	2.0	*	3
F931A476#BAAJ6	B	47	10	4.7	8	1.0	*	3
F931A476#CCAJ6	C	47	10	4.7	6	0.9	*	3
F931A686#BAAJ6	B	68	10	6.8	12	0.9	±15	3
F931A686#CCAJ6	C	68	10	6.8	8	0.8	*	3
F931A107#CCAJ6	C	100	10	10	10	0.7	*	3
F931A107#NCAJ6	N	100	10	10	8	0.6	*	3
F931A157#CCAJ6	C	150	10	15	14	0.7	*	3
F931A157#NCAJ6	N	150	10	15	10	0.6	*	3
F931A227#NCAJ6	N	220	10	22	12	0.5	*	3
F931A337#NCAJ6	N	330	10	33	18	0.5	*	3
<b>16 Volt</b>								
F931C105#AAAJ6	A	1	16	0.5	4	7.5	*	3
F931C155#AAAJ6	A	1.5	16	0.5	4	6.0	*	3
F931C225#AAAJ6	A	2.2	16	0.5	4	5.0	*	3
F931C335#AAAJ6	A	3.3	16	0.5	4	4.5	*	3
F931C475#AAAJ6	A	4.7	16	0.8	6	4.0	*	3
F931C685#AAAJ6	A	6.8	16	1.1	6	3.5	*	3
F931C106#AAAJ6	A	10	16	1.6	6	3.0	*	3

\*1: ΔC/C Marked “\*”

Item	All Case (%)
Damp Heat	±10
Temperature cycles	±10
Resistance soldering heat	±10
Surge	±10
Endurance	±10
Load Humidity	±10

AVX Part No.	Case Size	Capacitance (µF)	Rated Voltage (V)	DCL (µA)	DF @ 120Hz (%)	ESR @ 100kHz (Ω)	*1 ΔC/C (%)	MSL
F931C106#BAAJ6	B	10	16	1.6	6	2.0	*	3
F931C156#AAAJ6	A	15	16	2.4	10	3.0	*	3
F931C156#BAAJ6	B	15	16	2.4	6	2.0	*	3
F931C226#AAAJ6	A	22	16	3.5	15	3.0	±15	3
F931C226#BAAJ6	B	22	16	3.5	8	1.9	*	3
F931C226#CCAJ6	C	22	16	3.5	6	1.1	*	3
F931C336#BAAJ6	B	33	16	5.3	8	1.9	*	3
F931C336#CCAJ6	C	33	16	5.3	6	1.1	*	3
F931C476#BAAJ6	B	47	16	7.5	16	2.0	±15	3
F931C476#CCAJ6	C	47	16	7.5	8	0.9	*	3
F931C476#NCAJ6	N	47	16	7.5	6	0.7	*	3
F931C686#CCAJ6	C	68	16	10.9	10	0.8	*	3
F931C686#NCAJ6	N	68	16	10.9	6	0.6	*	3
F931C107#CCAJ6	C	100	16	16	15	0.7	*	3
F931C107#NCAJ6	N	100	16	16	10	0.6	*	3
F931C157#NCAJ6	N	150	16	24	15	0.6	*	3
<b>20 Volt</b>								
F931D225#AAAJ6	A	2.2	20	0.5	4	5.0	*	3
F931D335#AAAJ6	A	3.3	20	0.7	4	4.5	*	3
F931D475#AAAJ6	A	4.7	20	0.9	6	3.0	*	3
F931D475#BAAJ6	B	4.7	20	0.9	6	2.8	*	3
F931D685#AAAJ6	A	6.8	20	1.4	6	3.5	*	3
F931D685#BAAJ6	B	6.8	20	1.4	6	2.5	*	3
F931D106#AAAJ6	A	10	20	2	8	3.5	*	3
F931D106#BAAJ6	B	10	20	2	6	2.1	*	3
F931D156#CCAJ6	C	15	20	3	6	1.2	*	3
F931D226#BAAJ6	B	22	20	4.4	8	1.9	*	3
F931D226#CCAJ6	C	22	20	4.4	8	1.1	*	3
F931D336#CCAJ6	C	33	20	6.6	8	1.1	*	3
F931D336#NCAJ6	N	33	20	6.6	6	0.7	*	3
F931D476#CCAJ6	C	47	20	9.4	10	1.1	*	3
F931D476#NCAJ6	N	47	20	9.4	8	0.7	*	3
<b>25 Volt</b>								
F931E105#AAAJ6	A	1	25	0.5	4	7.5	*	3
F931E155#AAAJ6	A	1.5	25	0.5	4	6.7	*	3
F931E225#AAAJ6	A	2.2	25	0.6	6	6.3	*	3
F931E335#AAAJ6	A	3.3	25	0.8	6	6.0	*	3
F931E475#AAAJ6	A	4.7	25	1.2	8	4.0	*	3
F931E475#BAAJ6	B	4.7	25	1.2	6	2.8	*	3
F931E106#BAAJ6	B	10	25	2.5	12	1.9	*	3
F931E106#CCAJ6	C	10	25	2.5	6	1.5	*	3
F931E156#CCAJ6	C	15	25	3.8	8	1.2	*	3
F931E226#CCAJ6	C	22	25	5.5	8	1.1	*	3
F931E226#NCAJ6	N	22	25	5.5	6	0.7	*	3
F931E336#NCAJ6	N	33	25	8.3	8	0.7	*	3
F931E476#NCAJ6	N	47	25	11.8	8	0.7	*	3
<b>35 Volt</b>								
F931V105#AAAJ6	A	1	35	0.5	4	7.5	*	3
F931V155#AAAJ6	A	1.5	35	0.5	6	7.5	*	3
F931V225#AAAJ6	A	2.2	35	0.8	6	7.0	*	3
F931V225#BAAJ6	B	2.2	35	0.8	4	3.8	*	3
F931V335#BAAJ6	B	3.3	35	1.2	4	3.5	*	3
F931V475#BAAJ6	B	4.7	35	1.6	8	3.1	*	3
F931V475#CCAJ6	C	4.7	35	1.6	6	1.8	*	3
F931V685#CCAJ6	C	6.8	35	2.4	6	1.8	*	3
F931V106#CCAJ6	C	10	35	3.5	6	1.6	*	3
F931V156#NCAJ6	N	15	35	5.3	6	0.7	*	3
F931V226#NCAJ6	N	22	35	7.7	8	0.7	*	3
F931V336#NCAJ6	N	33	35	11.6	8	0.7	*	3

\*#: "M" for ±20% tolerance, "K" for ± 10% tolerance. When you need K tolerance for the part numbers which have M tolerance only, please contact to your local AVX sales office.  
Moisture Sensitivity Level (MSL) is defined according to J-STD-020.

### QUALIFICATION TABLE

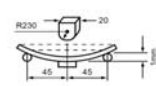
TEST	F93-AJ6 series (Temperature range -55°C to +125°C)	
	Condition	
<b>Damp Heat (Steady State)</b>	At 40°C, 90 to 95% R.H., 500 hours (No voltage applied) Capacitance Change ..... Refer to page 42 (*1) Dissipation Factor ..... Initial specified value or less Leakage Current ..... Initial specified value or less	
<b>Load Humidity</b>	After 1000 hour's application of rated voltage in series with a 33Ω resistor at 85°C, 85% R.H., capacitors meet the characteristics requirements table below. Capacitance Change ..... Refer to page 42 (*1) Dissipation Factor ..... Initial specified value or less Leakage Current ..... 125% or less than the initial specified value	
<b>Temperature Cycles</b>	At -55°C / +125°C, 30 minutes each, 1000 cycles Capacitance Change ..... Refer to page 42 (*1) Dissipation Factor ..... Initial specified value or less Leakage Current ..... Initial specified value or less	
<b>Resistance to Soldering Heat</b>	10 seconds reflow at 260°C, 10 seconds immersion at 260°C. Capacitance Change ..... Refer to page 42 (*1) Dissipation Factor ..... Initial specified value or less Leakage Current ..... Initial specified value or less	
<b>Surge</b>	After application of surge voltage in series with a 33Ω resistor at the rate of 30 seconds ON, 30 seconds OFF, for 1000 successive test cycles at 85°C, capacitors shall meet the characteristic requirements in the table above. Capacitance Change ..... Refer to page 42 (*1) Dissipation Factor ..... Initial specified value or less Leakage Current ..... Initial specified value or less	
<b>Endurance</b>	After 2000 hours' application of rated voltage in series with a 3Ω resistor at 85°C, or derated voltage in series with a 3Ω resistor at 125°C, capacitors shall meet the characteristic requirements in the table above. Capacitance Change ..... Refer to page 42 (*1) Dissipation Factor ..... Initial specified value or less Leakage Current ..... Initial specified value or less	
<b>Shear Test</b>	After applying the pressure load of 17.7N for 60 seconds horizontally to the center of capacitor side body which has no electrode and has been soldered beforehand on a substrate, there shall be found neither exfoliation nor its sign at the terminal electrode.	
<b>Terminal Strength</b>	Keeping a capacitor surface-mounted on a substrate upside down and supporting the substrate at both of the opposite bottom points 45mm apart from the center of capacitor, the pressure strength is applied with a specified jig at the center of the substrate so that substrate may bend by 1mm as illustrated. Then, there shall be found no remarkable abnormality on the capacitor terminals.	
<b>Failure Rate</b>	1% per 1000 hours at 85°C, $V_R$ with 0.1Ω/V series impedance, 60% confidence level.	

### AVX SOLID ELECTROLYTE CAPACITOR ROADMAP

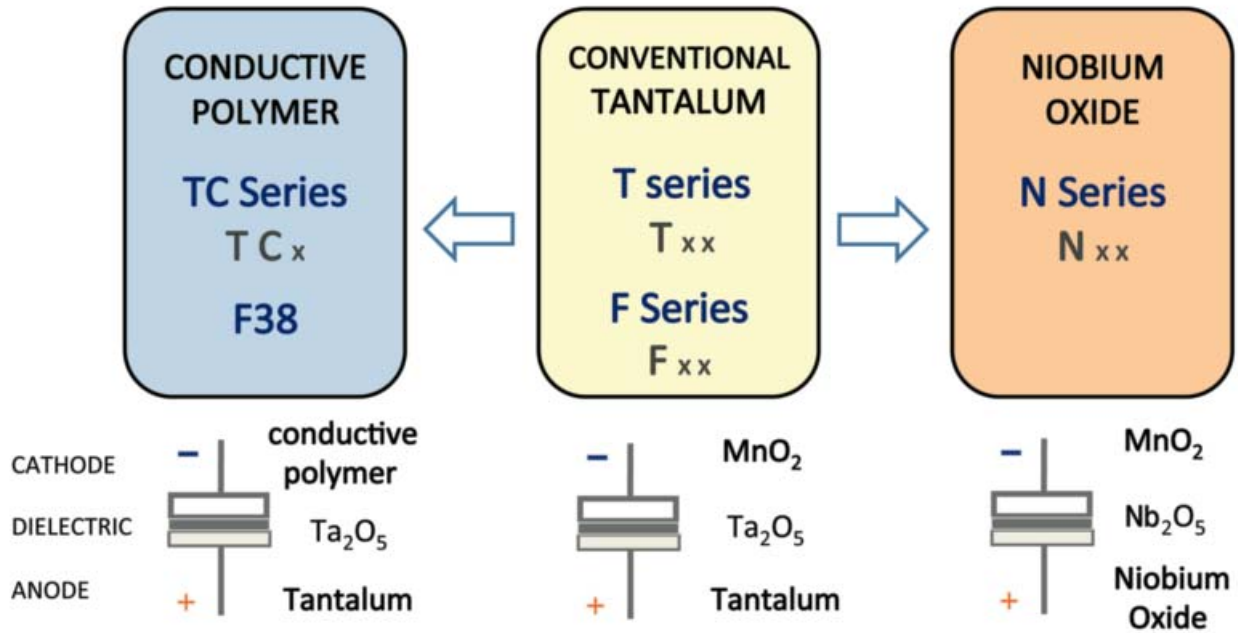

### Five Capacitor Construction Styles

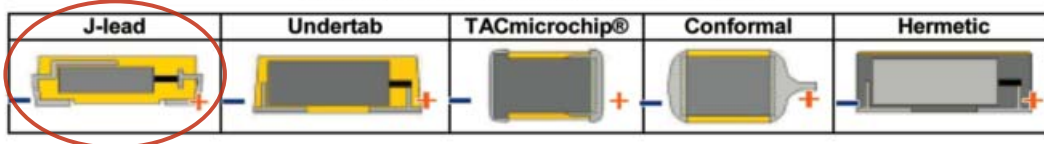

### SERIES LINE UP: CONVENTIONAL SMD MnO<sub>2</sub>

