

1

2

3

4

5

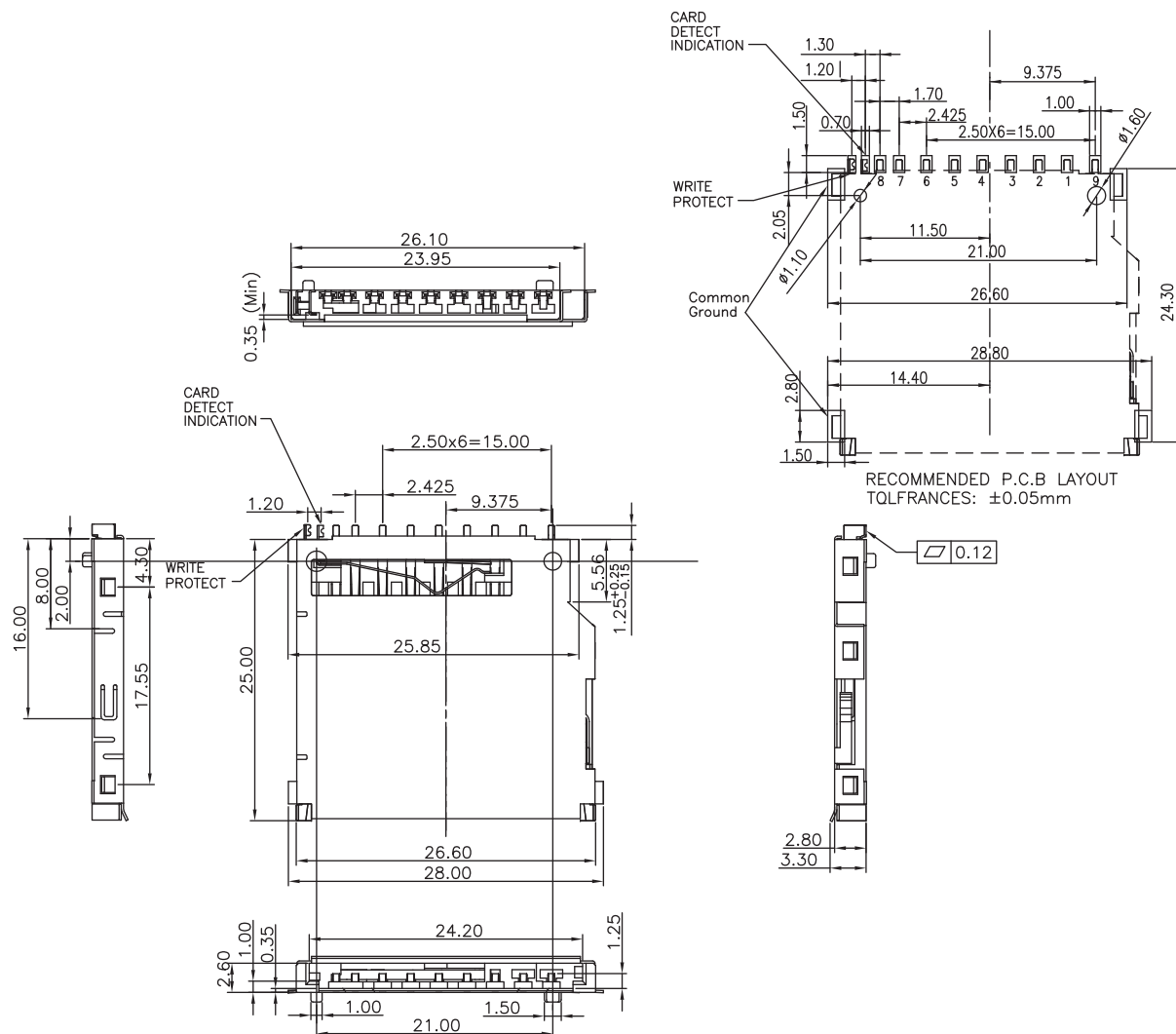

#### TECHNICAL CHARACTERISTICS

**MATERIAL**  
 INSULATOR: LCP  
 FLAMABILITY RATING: UL94-V0  
 COLOR: BLACK  
 CONTACT MATERIAL: COPPER ALLOY  
 CONTACT TYPE: STAMPED  
 CONTACT PLATING: SELECTIVE GOLD  
 SHIELDING: COPPER ALLOY  
 SHIELDING PLATING: NICKEL  
 QUALITY CLASS: 10000 MATING CYCLES

**ENVIRONMENTAL**  
 OPERATING TEMPERATURE: -25 UP TO 85°C  
 COMPLIANCE: LEAD FREE AND ROHS

**ELECTRICAL**  
 CURRENT RATING: 0.5A  
 WORKING VOLTAGE: 100VAC  
 INSULATOR RESISTANCE: >1000 MOHM  
 DIELECTRIC WITHSTANDING VOLTAGE: 500VAC/MN  
 CONTACT RESISTANCE: 100 mOHM MAX

**SOLDERING**  
 REFLOW PROCESS ONLY

**PACKAGING**  
 TAPE & REEL

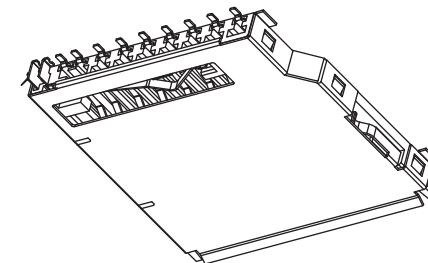

RoHS Compliant

PROJECTION:

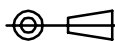

GENERAL TOLERANCE

.X =  $\pm 0.2$

.XX =  $\pm 0.15$



APPROVAL: RJ

UNIT: MM

SCALE:

SHEET: 1/3

DRAW: VICKY

**DESCRIPTION: SD Card Connector - Push & Pull - With Card Detection**  
 9 pins

**WERI PART NO: 693 063 010 911**

SIZE

**A4**

REV	DATE	FILE	BY
A	11-AUG-31	PDF	GG
B	16-FEB-12	TKP	GG
C	22-FEB-12	PAGE 2	GG
D	07-MAR-12	PAGE 2 SWITCH	GG

1

2

3

4

5

Contact OFF

Contact ON / Lock OFF

Contact ON / Lock ON



DETAIL L



K



DETAIL J



DETAIL K

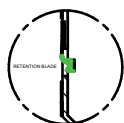

DETAIL N

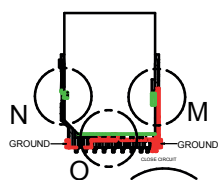

DETAIL O

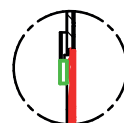

DETAIL M

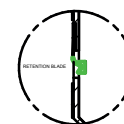

DETAIL Q

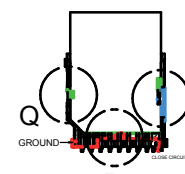

R

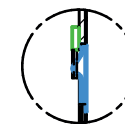

DETAIL P

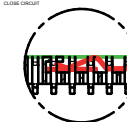

DETAIL R

Card detection switch		Write protection switch		
Card removed	Card inserted	Card removed	Card inserted	
			Write Protect	Write enable
OPEN	CLOSE	OPEN	OPEN	CLOSE

RoHS Compliant

PROJECTION:

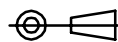

GENERAL TOLERANCE

.X =  $\pm 0.2$ .XX =  $\pm 0.15$ 

APPROVAL: RJ

UNIT: MM

SCALE:

SHEET: 2/3

DRAW: VICKY

DESCRIPTION: SD Card Connector - Push & Pull - With Card Detection  
9 pins

WERI PART NO: 693 063 010 911

SIZE

A4

REV

DATE

FILE

BY

1

2

3

4

5

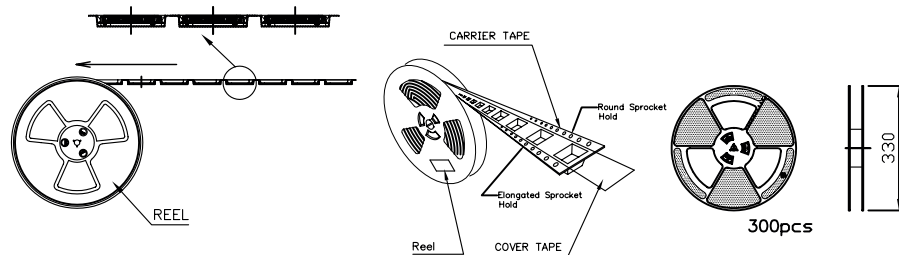
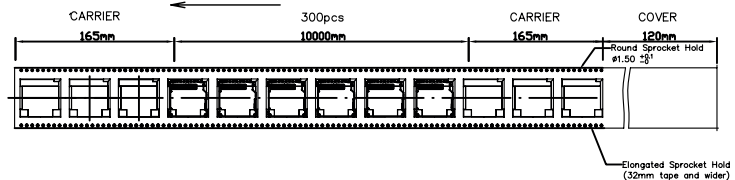
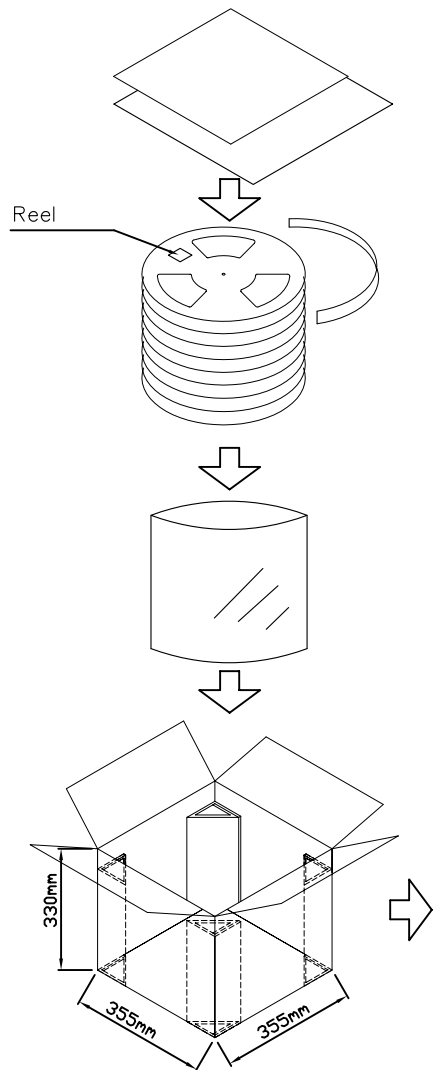

NOTES  
 1. MATERIALS: PS  
 2. PACKING: TAPE REEL(300PCS/R,1800PCS/CTN)  
 3. SONY SS-00259 or RoHS  
 All Material in According With The Rohs Environment Related Substances List Controlled.

RoHS Compliant			
REV	DATE	FILE	BY

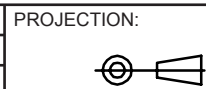

GENERAL TOLERANCE  
 .X =  $\pm 0.2$   
 .XX =  $\pm 0.15$



APPROVAL: RJ

UNIT: MM  
 SCALE:  
 SHEET: 3/3  
 DRAW: VICKY

DESCRIPTION: SD Card Connector - Push & Pull - With Card Detection  
 9 pins

WERI PART NO: 693 063 010 911

SIZE  
**A4**