

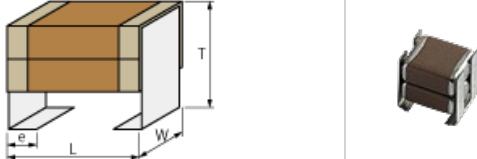

< List of part numbers with package codes >
 KRM55WR71H226MH01L , KRM55WR71H226MH01K

Shape



L size	6.1 ±0.4mm
W size	5.3 ±0.2mm
T size	6.4 ±0.3mm
Metal terminal width e	1.2±0.2mm

References

Packaging	Specifications	Minimum quantity
L	φ180mm Embossed taping	200
K	φ330mm Embossed taping	500

Mass (typ.)	
1 piece	0.85g

Specifications

Capacitance	22μF ±20%
Rated voltage	50Vdc
Temperature characteristics (complied standard)	X7R(EIA)
Capacitance change rate	±15%
Temperature range of temperature characteristics	-55 to 125°C
Operating temperature range	-55 to 125°C

Attention

- 1.This datasheet is downloaded from the website of Murata Manufacturing Co., Ltd. Therefore, it's specifications are subject to change or our products in it may be discontinued without advance notice. Please check with our sales representatives or product engineers before ordering.
- 2.This datasheet has only typical specifications because there is no space for detailed specifications. Therefore, please review our product specifications or consult the approval sheet for product specifications before ordering.

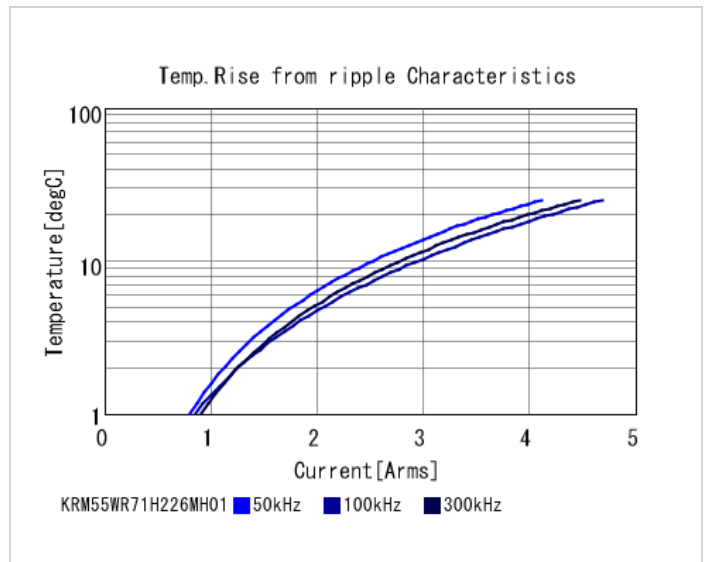
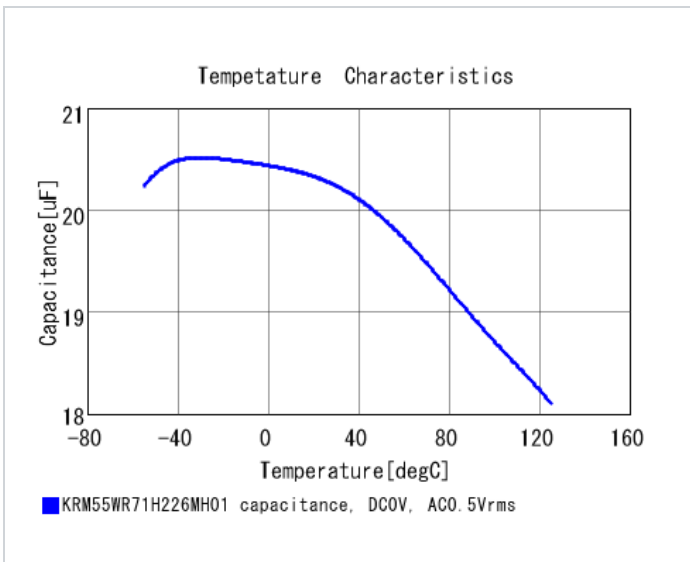
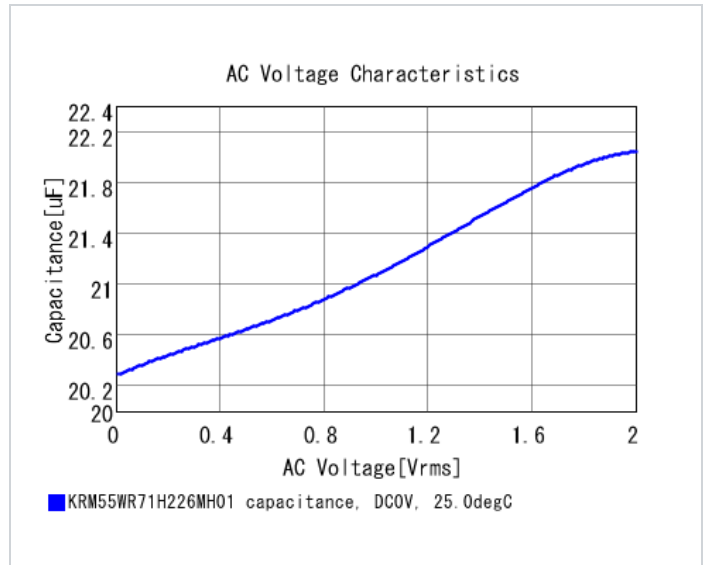
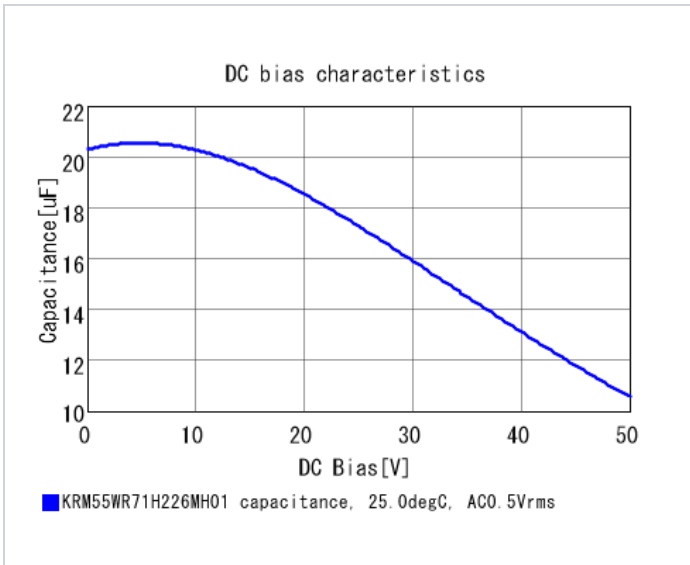
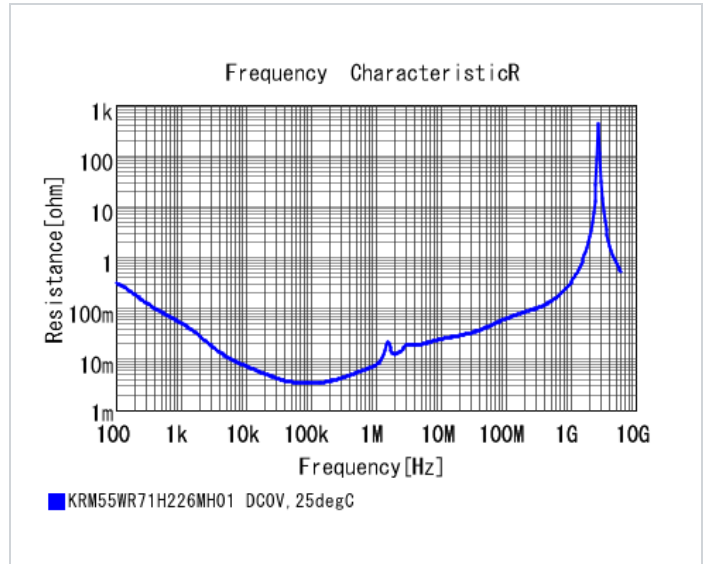
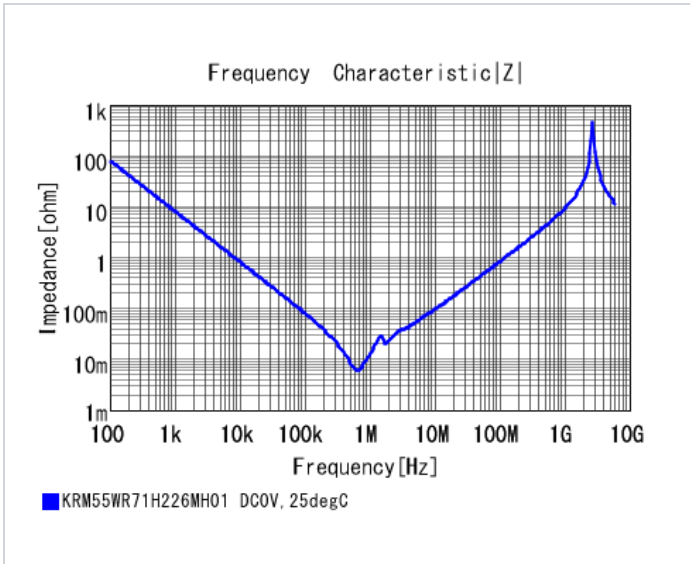

⚠ Attention

1.This datasheet is downloaded from the website of Murata Manufacturing Co., Ltd. Therefore, it's specifications are subject to change or our products in it may be discontinued without advance notice. Please check with our sales representatives or product engineers before ordering.

2.This datasheet has only typical specifications because there is no space for detailed specifications.

Therefore, please review our product specifications or consult the approval sheet for product specifications before ordering.