

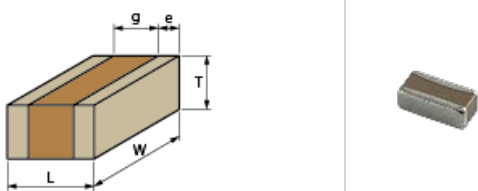

< List of part numbers with package codes >
 LLL317R71A474MA01L , LLL317R71A474MA01K

Shape



L size	1.6 ±0.15mm
W size	3.2 ±0.15mm
T size	0.7 ±0.1mm
External terminal width e	0.35±0.15mm
Distance between external terminals g	0.5mm min.
Size code in inch(mm)	0612 (1632M)

References

Packaging	Specifications	Minimum quantity
L	φ180mm Embossed taping	4000
K	φ330mm Embossed taping	10000

Mass (typ.)	
1 piece	20mg
φ180mm Reel	208g

Specifications

Capacitance	0.47μF ±20%
Rated voltage	10Vdc
Temperature characteristics (complied standard)	X7R(EIA)
Capacitance change rate	±15.0%
Temperature range of temperature characteristics	-55 to 125°C
Operating temperature range	-55 to 125°C

Attention

- 1.This datasheet is downloaded from the website of Murata Manufacturing Co., Ltd. Therefore, it's specifications are subject to change or our products in it may be discontinued without advance notice. Please check with our sales representatives or product engineers before ordering.
- 2.This datasheet has only typical specifications because there is no space for detailed specifications. Therefore, please review our product specifications or consult the approval sheet for product specifications before ordering.