

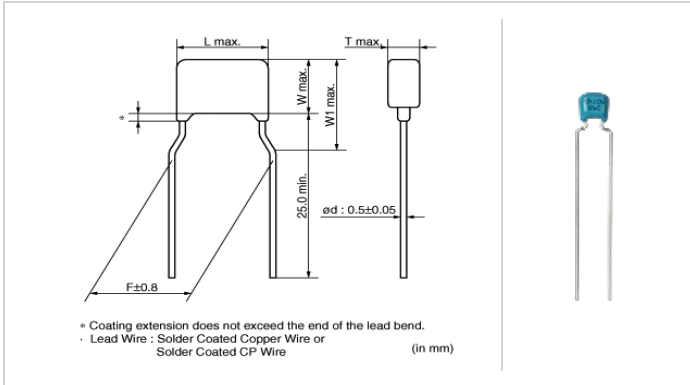

< List of part numbers with package codes >
RCER73A152K2K1H03B

Shape



L size or outer diameter D (mm)	5.5 mm max.
W size	4.0 mm max.
T size	3.15 mm max.
Lead spacing F	5.0 ±0.8mm
Lead diameter d	0.5 ±0.05mm
W1 size (max.)	6.0mm

Notes

Meet LF(Lead Free)[※LF : Lead content is less than 1000 ppm.], HF(Halogen Free)

References

Packaging	Specifications	Minimum quantity
B	Packing in bulk	500

Specifications

Capacitance	1500pF ±10%
Rated voltage	1000Vdc
Temperature characteristics (complied standard)	X7R(EIA)
Capacitance change rate	±15%
Temperature range of temperature characteristics	-55 to 125°C
Operating temperature range	-55 to 125°C

Attention

- 1.This datasheet is downloaded from the website of Murata Manufacturing Co., Ltd. Therefore, it's specifications are subject to change or our products in it may be discontinued without advance notice. Please check with our sales representatives or product engineers before ordering.
- 2.This datasheet has only typical specifications because there is no space for detailed specifications. Therefore, please review our product specifications or consult the approval sheet for product specifications before ordering.