

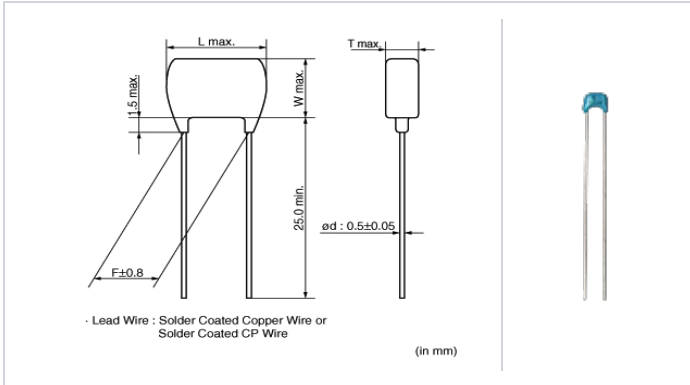

< List of part numbers with package codes >  
RHE5G2A271J0A2H03B

**Shape**



L size or outer diameter D (mm)	3.6 mm max.
W size	3.5 mm max.
T size	2.5 mm max.
Lead spacing F	2.5 ±0.8mm
Lead diameter d	0.5 ±0.05mm

**Notes**

Meet LF(Lead Free)[※LF : Lead content is less than 1000 ppm.], HF(Halogen Free)

**References**

Packaging	Specifications	Minimum quantity
B	Packing in bulk	500

**Specifications**

Capacitance	270pF ±5%
Rated voltage	100Vdc
Temperature characteristics (complied standard)	X8G(Murata)
Temperature coefficient	20 to 150°C: 0±30ppm/°C -55 to 25°C: 0+30/-72ppm/°C
Temperature range of temperature characteristics	-55 to 150°C
Operating temperature range	-55 to 150°C

**Attention**

- 1.This datasheet is downloaded from the website of Murata Manufacturing Co., Ltd. Therefore, it's specifications are subject to change or our products in it may be discontinued without advance notice. Please check with our sales representatives or product engineers before ordering.
- 2.This datasheet has only typical specifications because there is no space for detailed specifications. Therefore, please review our product specifications or consult the approval sheet for product specifications before ordering.