

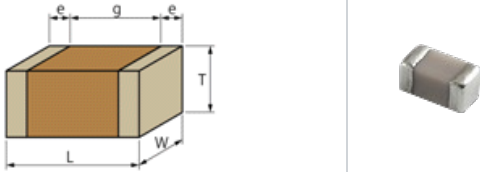



< List of part numbers with package codes >  
GJM0225C1E9R8BB01L

**Shape**

L size	0.4 ±0.02mm
W size	0.2 ±0.02mm
T size	0.2 ±0.02mm
External terminal width e	0.07 to 0.14mm
Distance between external terminals g	0.13mm min.
Size code in inch(mm)	01005 (0402M)

**References**

Packaging	Specifications	Minimum quantity
L	φ 180mm Embossed taping	40000

Mass (typ.)	
1 piece	0.09mg
φ 180mm Reel	198g

**Specifications**

Capacitance	9.8pF ±0.1pF
Rated voltage	25Vdc
Temperature characteristics (complied standard)	C0G(EIA)
Temperature coefficient	0±30ppm/°C
Temperature range of temperature characteristics	25 to 125°C
Operating temperature range	-55 to 125°C

**Attention**

- 1.This datasheet is downloaded from the website of Murata Manufacturing Co., Ltd. Therefore, it's specifications are subject to change or our products in it may be discontinued without advance notice. Please check with our sales representatives or product engineers before ordering.
- 2.This datasheet has only typical specifications because there is no space for detailed specifications. Therefore, please review our product specifications or consult the approval sheet for product specifications before ordering.