



GQM22M5C2H2R8WB01#

indicates a package specification code.

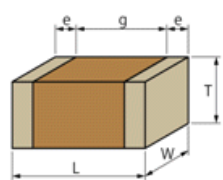

< List of part numbers with package codes >
 GQM22M5C2H2R8WB01L , GQM22M5C2H2R8WB01K

Shape

L size	2.8 ±0.5mm
W size	2.8 ±0.4mm
T size	1.15 ±0.2mm
External terminal width e	0.3mm min.
Distance between external terminals g	1.0mm min.
Size code in inch(mm)	1111 (2828M)

References

Packaging	Specifications	Minimum quantity
L	φ 180mm Embossed taping	1000
K	φ 330mm Embossed taping	4000

Mass (typ.)	
1 piece	41mg
φ 180mm Reel	73g

Specifications

Capacitance	2.8pF ±0.05pF
Rated voltage	500Vdc
Temperature characteristics (complied standard)	C0G(EIA)
Temperature coefficient	0±30ppm/°C
Temperature range of temperature characteristics	25 to 125°C
Operating temperature range	-55 to 125°C

Attention

- 1.This datasheet is downloaded from the website of Murata Manufacturing Co., Ltd. Therefore, it's specifications are subject to change or our products in it may be discontinued without advance notice. Please check with our sales representatives or product engineers before ordering.
- 2.This datasheet has only typical specifications because there is no space for detailed specifications. Therefore, please review our product specifications or consult the approval sheet for product specifications before ordering.