

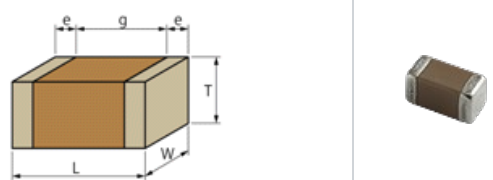

< List of part numbers with package codes >  
GRM0225C1C6R8WA03L

**Shape**



|                                       |                |
|---------------------------------------|----------------|
| L size                                | 0.4 ±0.02mm    |
| W size                                | 0.2 ±0.02mm    |
| T size                                | 0.2 ±0.02mm    |
| External terminal width e             | 0.07 to 0.14mm |
| Distance between external terminals g | 0.13mm min.    |
| Size code in inch(mm)                 | 01005 (0402M)  |

**References**

| Packaging | Specifications          | Minimum quantity |
|-----------|-------------------------|------------------|
| L         | φ 180mm Embossed taping | 40000            |

| Mass (typ.)  |        |
|--------------|--------|
| 1 piece      | 0.09mg |
| φ 180mm Reel | 198g   |

**Specifications**

|  |               |
|--|---------------|
| Capacitance                                      | 6.8pF ±0.05pF |
| Rated voltage                                    | 16Vdc         |
| Temperature characteristics (complied standard)  | C0G(EIA)      |
| Temperature coefficient                          | 0±30ppm/°C    |
| Temperature range of temperature characteristics | 25 to 125°C   |
| Operating temperature range                      | -55 to 125°C  |

**Attention**

- 1.This datasheet is downloaded from the website of Murata Manufacturing Co., Ltd. Therefore, it's specifications are subject to change or our products in it may be discontinued without advance notice. Please check with our sales representatives or product engineers before ordering.
- 2.This datasheet has only typical specifications because there is no space for detailed specifications. Therefore, please review our product specifications or consult the approval sheet for product specifications before ordering.

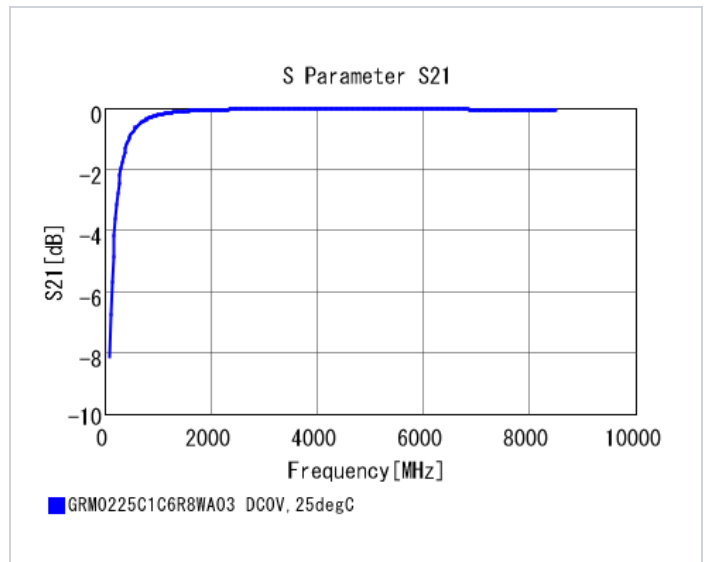
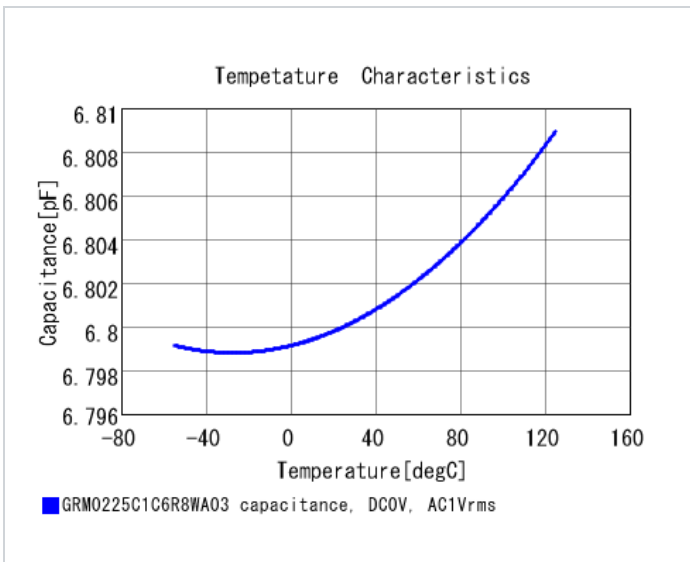
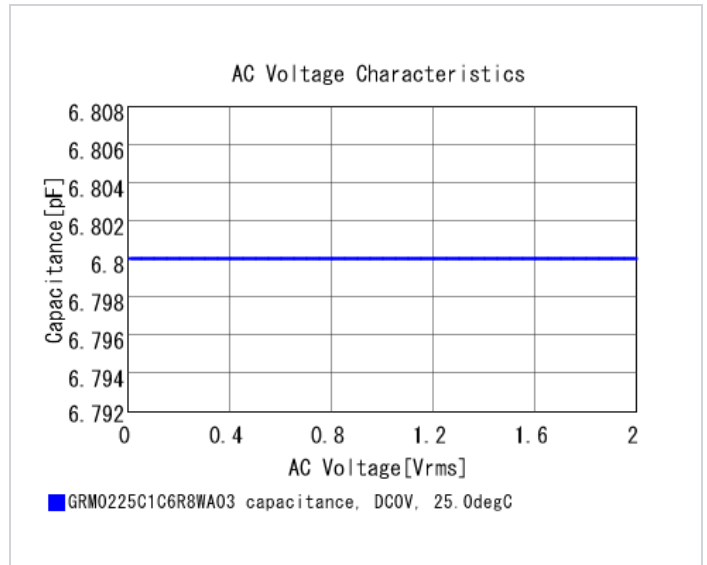
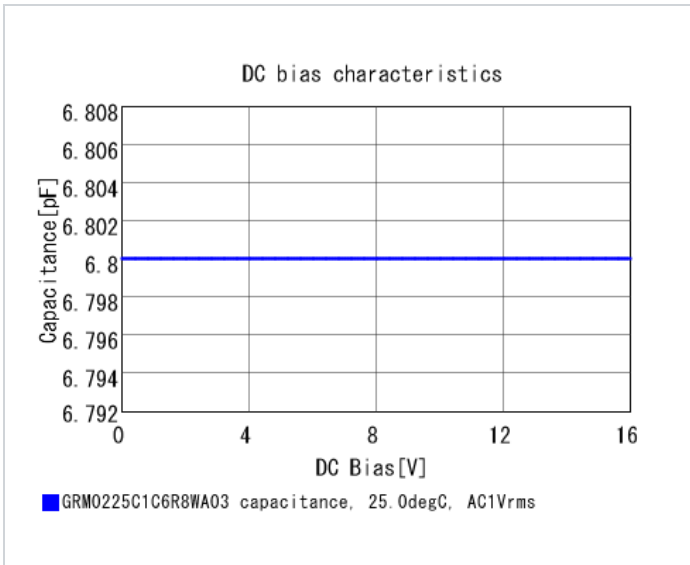
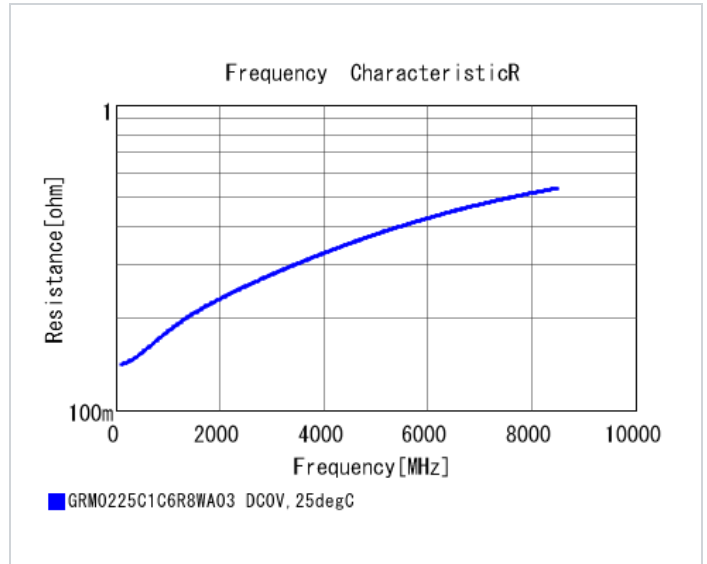
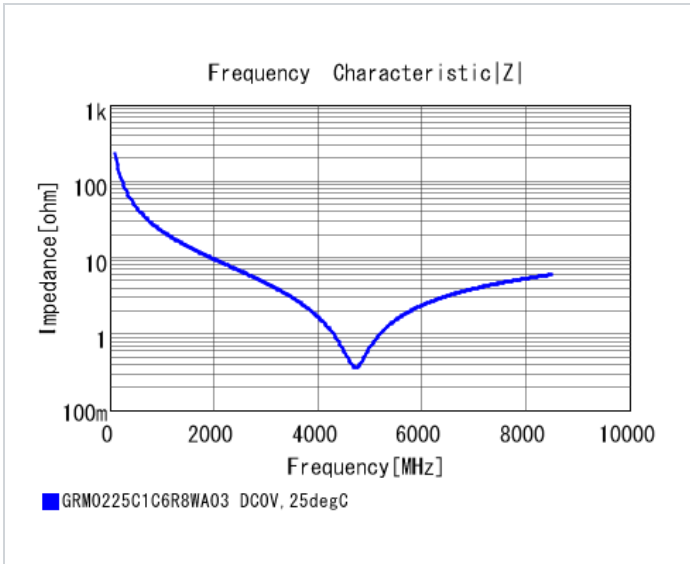

**⚠ Attention**

1.This datasheet is downloaded from the website of Murata Manufacturing Co., Ltd. Therefore, it's specifications are subject to change or our products in it may be discontinued without advance notice. Please check with our sales representatives or product engineers before ordering.

2.This datasheet has only typical specifications because there is no space for detailed specifications. Therefore, please review our product specifications or consult the approval sheet for product specifications before ordering.